



June 2023

## **CPSC Staff Statement<sup>1</sup> on Boise State University’s, “Seated Products Characterization and Testing”**

The attached report, titled, “Seated Products Characterization and Testing,” presents the findings of research conducted by Dr. Erin Mannen at Boise State University, for the U.S. Consumer Product Safety Commission (CPSC), under Contract 61320620D0002, Task 61320621F1014.

CPSC staff contracted with Boise State University to undertake a multifaceted approach (*e.g.*, evaluation of incident data, product assessments, limited human subject testing) to compare and evaluate infant seated products: infant carriers, bouncers, swings, rockers, strollers, and infant floor seats. CPSC supported the research to assess how the design characteristics of seated products affect trunk flexion and chin-to-chest positioning when the infant is in the supine position, or in the prone position should an infant roll from supine into prone, and how the design might prevent an infant from self-correcting to avoid injury (*e.g.*, moving their head to free their nose or mouth to allow adequate respiration).

The Boise State University researchers included biomechanical engineers, a pediatric pulmonologist, and consultants in developing test devices. They evaluated the safety of seated products for infants by testing infants within the product and learning how infants use their muscles to move within its confines. In addition, the research team evaluated airflow around and through the product as it relates to the material thickness and softness, infant head angle, and the products’ conformity to infants’ face from the scenarios described above.

Based on the testing of infants in various seated products, their review of 47 in-depth incident investigations, the testing of 24 products representing various seated product categories, and a review of past research, the researchers identify test methods and fixtures/probes that can be used for standards development, as well as information and education elements for caregivers. The report recommends that seated products not be used for infant sleep. The researchers also recommend that seated products not envelop the infants head/face, provide sufficient space for the infant’s head to rotate without contacting the side walls, and have firmness similar to a crib mattress, to minimize the risk of suffocation.

---

<sup>1</sup> This statement was prepared by the CPSC staff, and the attached report was prepared by Boise State University, for CPSC staff. This statement and the attached report have not been reviewed or approved by, and do not necessarily represent the views of, the Commission.

# Seated Products Characterization and Testing

*Authors:* Erin M. Mannen, Ph.D.<sup>1</sup>; Danielle Siegel<sup>1</sup>; Sarah Goldrod<sup>1</sup>; Andrew Bossart<sup>1</sup>, Trevor J. Lujan, Ph.D.<sup>1</sup>; Christopher Wilson<sup>1</sup>; Brandi Whitaker, Ph.D.<sup>2</sup>; John Carroll, M.D.<sup>2</sup>

*Institutions:* <sup>1</sup>Mechanical and Biomedical Engineering Department, Boise State University, Boise, Idaho, USA. <sup>2</sup>Arkansas Children's Research Institute, Little Rock, Arkansas, USA.

We thank Michael Leshner for his insight into the test device development, and students Sabrina Mead, Andrew Altman, and Cameron Waite for their assistance with manufacturing, testing, and data processing.

Research was conducted from October 2021 to May 2023.

# Table of Contents

## Contents

Table of Contents.....	2
List of Figures .....	5
List of Tables .....	14
Abbreviations.....	16
1. Introduction and Report Overview .....	17
2. In-Depth Investigations.....	20
2.1 In-Depth Investigation Overview .....	20
2.2 In-Depth Investigation Methods.....	21
2.3 In-Depth Investigations Results and Discussion .....	22
2.4 In-Depth Investigations Conclusions.....	31
3. Product Selection, Characterization, and Measurement.....	32
3.1 Product Selection .....	32
3.2 Product Characterization Methods.....	35
3.3 Product Characterization Results.....	37
3.4 Product Characterization Discussion .....	54
3.5 Product Characterization Conclusions .....	58
4. Head Rotation Testing.....	59
4.1 Head Rotation Overview .....	59
4.2 Head Rotation Methods.....	61
4.3 Head Rotation Results.....	62
4.4 Head Rotation Discussion .....	64
4.5 Head Rotation Conclusions .....	65
5. Concavity and Conformity Testing.....	66
5.1 Concavity and Conformity Testing Overview.....	66
5.2 Concavity and Conformity Testing Methods .....	69
5.3 Concavity and Conformity Testing Results .....	71
5.4 Concavity and Conformity Testing Discussion .....	75
5.5 Concavity and Conformity Testing Conclusions.....	78
6. Firmness Testing .....	79
6.1 Firmness Testing Overview .....	79

6.2 Firmness Testing Methods .....	80
6.3 Firmness Testing Results .....	85
6.4 Firmness Testing Discussion.....	87
6.5 Firmness Testing Conclusions .....	88
7. Airflow Testing .....	89
7.1 Airflow Testing Overview .....	89
7.2 Airflow Testing Methods.....	90
7.3 Airflow Testing Results.....	92
7.4 Airflow Testing Discussion .....	99
7.5 Airflow Testing Conclusions .....	101
8. <i>In vivo</i> Human Subjects Testing .....	102
8.1 <i>In vivo</i> Human Subjects Testing Overview .....	102
8.2 <i>In vivo</i> Human Subjects Testing Methods.....	104
8.2.1 Human Subjects Testing Logistics .....	104
8.2.2 Human Subjects Data Collection.....	106
8.2.3 Human Subjects Data Analysis.....	109
8.3 <i>In vivo</i> Human Subjects Testing Results.....	113
8.3.1 Overall Results .....	113
8.3.2 Kinematic Results.....	124
8.3.3 EMG Results .....	138
8.4 <i>In vivo</i> Human Subjects Testing Discussion .....	161
8.4.1 Supine Lying .....	161
8.4.2 Prone Lying.....	170
8.4.3 Other Considerations .....	173
8.5 <i>In vivo</i> Human Subjects Testing Summary.....	175
9. Sagittal Plane Testing .....	176
9.1 Sagittal Plane Testing Overview.....	176
9.2 Sagittal Plane Testing Methods.....	177
9.3 Sagittal Plane Testing Results .....	183
9.4 Sagittal Plane Testing Discussion .....	195
9.5 Sagittal Plane Testing Conclusions.....	198
10. Summary of Key Points, Recommendations, and Conclusions.....	199
References .....	203



Appendix A: Seated Product Information ..... 212  
Appendix B: Handheld Firmness Tester Details ..... 215

## List of Figures

Figure 1. Schematic of overall research plan and report structure. ....	19
Figure 2. Map of the continental United States showing locations of all 47 IDIs reviewed, where a red pin represents a death and a yellow pin represents an injury. ....	22
Figure 3. Flowchart of IDIs broken down by hazard type. ....	24
Figure 4. Flow chart of IDI characterizations. ....	26
Figure 5. Photos of the infant carriers, bouncers, and strollers chosen for this study, along with the sample numbers. ....	33
Figure 6. Photos of the rockers, swings, and infant floor seats chosen for this study along with the sample numbers. ....	34
Figure 7. Schematic of measurements from infant-sized hinged weight gauge. ....	36
Figure 8. Photos of testing with the infant-sized hinged weight gauge for infant carriers, bouncers, and strollers. ....	39
Figure 9. Photos of testing with the infant-sized hinged weight gauge for rockers and swings. ....	40
Figure 10. Warning labels from infant carrier products. ....	45
Figure 11. Warning labels from bouncer products. ....	46
Figure 12. Warning labels for stroller products. ....	47
Figure 13. Warning labels on rocker products. ....	48
Figure 14. Warning labels on swing products. ....	49
Figure 15. Warning labels on infant floor seat products. The photo of the warning label on S28 has rubbed off due to the duct tape we placed over the warning label prior to human subjects testing. However, the language was inscribed prior to this photo. ....	50
Figure 16. Example of an (A) and (B) and failed test and (C) and (D) a passed test. ....	61
Figure 17. Head rotation failures for (A) and (B) product S10 in the intended position; and (C) and (D) product S21 in the slouched position. Product S10 failed in the intended position, while product S21 failed in both the intended and the slouched position. ....	63
Figure 18. Schematic drawing from the top of the head looking down, where the green arrows or red x represent the nose and mouth region, depicting an infant lying supine (A) on a crib mattress with no head rotation, (B) on a crib mattress with a 90° head rotation, (C) on a soft and conforming product with	

no head rotation, and (D) on a soft and conforming product with 90° head rotation depicting the nose and mouth region in direct contact with the plush soft side of the product, creating a serious suffocation hazard. .... 67

Figure 19. Schematic drawing from the top of the head looking down, where the green arrows or red x represent the nose and mouth region, depicting an infant lying prone (A) on a crib mattress with no head rotation, (B) on a crib mattress with a slight head rotation to free their nose to breathe, (C) on a soft and conforming product with no head rotation, and (D) on a soft and conforming product requiring significant head rotation (60° in this example) to free the nose to breath, creating a serious suffocation hazard especially if an infant does not have head control and neck strength. .... 68

Figure 20. Example measurements on a representative product for the head measurement in the (A) unweighted and (B) weighted conditions; and for the seat measurement in the (C) unweighted and (D) weighted conditions..... 69

Figure 21. Example of the best-fit circle and the radius (r) for two different products, showing how the smaller radius correlates to a more concave product. .... 70

Figure 22. The concavity of each product at the head location, with (weighted) and without (unweighted) the infant five-segment device in the intended position. The smaller the radius, the more concave the product. The S24 unweighted radius was 128 cm. .... 71

Figure 23. The concavity of each product at the seat location, with (weighted) and without (unweighted) the infant five-segment device in the intended position. The smaller the radius, the more concave the product..... 72

Figure 24. The conformity of each product at the head location. The larger the change in radius ( $\Delta r$ ), the more conforming the product is to a load representative of an infant. S24 exhibited a large  $\Delta r$  of 103 cm, indicating it is a conforming product. .... 73

Figure 25. The conformity of each product at the seat location. The larger the change in radius ( $\Delta r$ ), the more conforming the product is to a load representative of an infant. S19 exhibited a large  $\Delta r$  of 20 cm, indicating it is a conforming product. .... 73

Figure 26. Depiction of the top view of an infant’s head showing a 7.3 cm radius, lying within a to-scale example of a product with a 22 cm concavity radius. .... 76

Figure 27. Depiction of a smaller pillow in S11 resulting in no mouth/nose contact during supine lying with a head turn, compared to a larger pillow in S21 which results in mouth/nose contact. .... 77

Figure 28. Handheld firmness tester featuring (1) wooden hemisphere; (2) copper tubing used for airflow testing; (3) force gauge; (4) circular aluminum footprint; and (5) depth gauge. .... 81

Figure 29. Crib mattresses used to determine firmness threshold using handheld firmness device. .... 82

Figure 30. Photos showing the prone (P, red circles) and first contact supine (S, yellow circles) locations for firmness and airflow testing on a representative seated product from each product category..... 83

Figure 31. Firmness testing on bouncer S12 with handheld device at (Left) the prone position, and (Right) the first contact supine position. During testing, we used both hands to apply force. Only one hand is used in these photos to better visualize the testing location..... 84

Figure 32. Firmness testing results in the prone position where the aqua line represents the 11 mm displacement threshold. We did not identify a prone location for products S26 and S28. .... 85

Figure 33. Firmness testing results in the supine position where the aqua line represents the 11.0 mm displacement threshold. .... 86

Figure 34. Airflow apparatus featuring (1) digital manometer, (2) flowmeter, (3) pump, and (4) handheld firmness and airflow testing device. .... 90

Figure 35. Airflow testing using handheld device on swing S18 in the (Left) prone position, and (Right) first contact supine position. .... 91

Figure 36. Airflow testing results in the prone position at contact (0.25 N) for all products where any pressure values below the aqua line represents mesh-like airflow. S16 exhibited 16.2 in H<sub>2</sub>O. .... 92

Figure 37. Airflow testing results in the prone position at a 10 N load for all products where any pressure values below the aqua line represents mesh-like airflow. S16 exhibited 29.0 in H<sub>2</sub>O, S19 9.2 in H<sub>2</sub>O, and S20 9.4 in H<sub>2</sub>O. .... 93

Figure 38. Airflow testing results in the supine position in contact (0.25 N) for all products where any pressure values below the pink line represents mesh-like airflow. .... 93

Figure 39. Airflow testing results in the supine position with a 10 N load for all products where any pressure values below the pink line represents mesh-like airflow. S05 exhibited 17.8 in H<sub>2</sub>O, S13 18.0 in H<sub>2</sub>O, S16 26.7 in H<sub>2</sub>O, and S20 9.3 in H<sub>2</sub>O. .... 94

Figure 40. Scatterplot of firmness vs. airflow for each product in the prone position with a 10 N applied load. .... 95

Figure 41. Scatterplot of firmness vs. airflow for each product in the first contact supine position. .... 96

Figure 42. Products selected for the human subjects testing. .... 105

Figure 43. Retro-reflective marker placement on infants. ASIS: anterior superior iliac spine; PSIS: posterior superior iliac spine. .... 107

Figure 44. Electromyography (EMG) sensor placement on infants. AB: abdominals; QUAD: quadriceps; CP: cervical paraspinal; ES: erector spinae. .... 108

Figure 45. Schematic explaining the sagittal plane kinematic variables we calculated from the motion capture data.....	110
Figure 46. Schematic showing how the torso flexion and extension values were calculated using the motion capture data. $L_s$ is the length of the trunk during supine lying, and $L_f$ is the length of the trunk during flexion. ....	111
Figure 47. Schematic showing how adjustment angles were calculated to account for the offset between the frontal plane and the location of the retro-reflective markers. First, we used the Law of Cosines to find $\theta$ . The variable $t$ is the distance between the ASIS and PSIS markers, representing the thickness of the infant’s pelvis. The length of the lower torso and the upper torso equals the total torso distance from the playmat condition. Finally, we calculated $\alpha$ for each infant, and used this as the adjustment angle for all torso flexion and extension calculations in all conditions. ....	112
Figure 48. Experimental photos of infants in the playmat condition. ....	114
Figure 49. Experimental photos of infants in the infant carrier condition. ....	115
Figure 50. Experimental photos of infants in the bouncer condition.....	116
Figure 51. Experimental photos of infants in the stroller condition.....	117
Figure 52. Experimental photos of infants in the rocker condition. ....	118
Figure 53. Experimental photos of infants in the swing condition. ....	119
Figure 54. Experimental photos of infants in the infant floor seat condition. ....	120
Figure 55. Example of infants with their faces in direct contact with the playmate and products during prone positioning (Playmat, S06, S12, S17, and S24) and intended positioning (S28). Some of these infants remained in contact with the product for the entire 60 second trials. ....	121
Figure 56. Examples of prone positioning in the swing. Some infants caused the swing to rotate forward during prone positioning due to the shift in the center of gravity. ....	122
Figure 57. Example of a chin-to-chest position for an infant in the intended supine position in the swing condition. ....	122
Figure 58. Examples of unusual circumstances we noted. (A) and (C) show sliding within the product; (B) and (D) represent infants attempting crawling maneuvers in the prone position; and (E) and (F) are examples of rolling movements during supine lying in products. ....	123
Figure 59. Supine lying head-neck angles for infants in all conditions, where the bar represents the average excursion for the infants and the black dot represents the mean, normalized to the mean of the playmat condition. Top: data for all infants; Left: data for younger infants; Right: data for older infants. * $p < 0.05$ mean vs. playmat condition.....	124

Figure 60. Supine lying torso or trunk flexion angles for infants in all conditions, where the bar represents the average excursion for the infants and the black dot represents the mean, normalized to the mean of the playmat condition. Top: data for all infants; Left: data for younger infants; Right: data for older infants. Data from the stroller, infant floor seat, and infant carrier positions could not be used due to covered retroreflective markers. \* $p < 0.05$  mean vs. playmat condition. .... 125

Figure 61. Supine lying torso-pelvis flexion angles for infants in all conditions, where the bar represents the average excursion for the infants and the black dot represents the mean, normalized to the mean of the playmat condition. Top: data for all infants; Left: data for younger infants; Right: data for older infants. Data from the stroller and infant floor seat positions could not be used due to covered retroreflective markers. \* $p < 0.05$  mean vs. playmat condition. .... 126

Figure 62. Supine lying head-neck flexion angles for infants in all conditions in a quiet lying position, normalized to the mean in the playmat condition. Top: data for all infants; Left: data for younger infants; Right: data for older infants. Data from the infant floor seat condition could not be used due to covered retroreflective markers. \* $p < 0.05$  median vs. playmat condition. .... 127

Figure 63. Supine lying trunk or torso flexion angles for infants in all conditions in a quiet lying position, normalized to the mean in the playmat condition. Top: data for all infants; Left: data for younger infants; Right: data for older infants. Data from the infant carrier, stroller, and infant floor seat conditions could not be used due to covered retroreflective markers. \* $p < 0.05$  median vs. playmat condition. .... 128

Figure 64. Supine lying torso-pelvis flexion angles for infants in all conditions in a quiet lying position, normalized to the mean in the playmat condition. Top: data for all infants; Left: data for younger infants; Right: data for older infants. Data from the stroller and infant floor seat conditions could not be used due to covered retroreflective markers. \* $p < 0.05$  median vs. playmat condition. .... 129

Figure 65. Number of times infants reached a 10° head-neck flexion angle during each trial, presented as (top) all ages, (left) younger infants, and (right) older infants. .... 131

Figure 66. Number of times infants reached a 30° head-neck flexion angle during each trial, presented as (top) all ages, (left) younger infants, and (right) older infants. .... 132

Figure 67. The percentage of time that infants spent in >30° head-neck flexion angle during each trial, presented as (top) all ages, (left) younger infants, and (right) older infants. .... 133

Figure 68. Prone lying torso or trunk flexion angles for infants in all conditions, where the bar represents the average excursion for the infants and the black dot represents the mean, normalized to the mean of the prone playmat condition. The infant floor seat and stroller were unable to be tested in the prone position. Top: data for all infants; Left: data for younger infants; Right: data for older infants. \* $p < 0.05$  mean vs. playmat condition. .... 134

Figure 69. Prone lying torso-pelvis flexion angles for infants in all conditions, where the bar represents the average excursion for the infants and the black dot represents the mean, normalized to the mean of the prone playmat condition. The infant floor seat and stroller were unable to be tested in the prone

position. Top: data for all infants; Left: data for younger infants; Right: data for older infants. \*p<0.05 mean vs. playmat condition..... 135

Figure 70. Mean ( $\pm$ standard error) time that infants' faces were in contact with the seated product in the prone condition for (Top) all infants, (Left) younger infants, and (Right) older infants. There were no differences between younger and older infants. \*p<0.05 vs. playmat condition..... 137

Figure 71. Bilateral mean ( $\pm$ standard error) EMG values for cervical paraspinal (CP) muscles of infants during supine lying in all conditions. The black line represents the playmat, and all data was normalized to this value. Top: data for all infants; Right: data for younger infants; and Left: data for older infants. \*p<0.05 vs. the playmat condition. .... 138

Figure 72. Bilateral mean ( $\pm$ standard error) EMG values for erector spinae (ES) muscles of infants during supine lying in all conditions. The black line represents the playmat, and all data was normalized to this value. Top: data for all infants; Right: data for younger infants; and Left: data for older infants. \*p<0.05 vs. the playmat condition. .... 139

Figure 73. Bilateral mean ( $\pm$ standard error) EMG values for abdominal (AB) muscles of infants during supine lying in all conditions. The black line represents the playmat, and all data was normalized to this value. Top: data for all infants; Right: data for younger infants; and Left: data for older infants. \*p<0.05 vs. the playmat condition. .... 140

Figure 74. Bilateral mean ( $\pm$ standard error) EMG values for quadriceps (QUAD) muscles of infants during supine lying in all conditions. The black line represents the playmat, and all data was normalized to this value. Top: data for all infants; Right: data for younger infants; and Left: data for older infants. \*p<0.05 vs. the playmat condition. .... 141

Figure 75. Bilateral mean ( $\pm$ standard error) EMG values for all muscle groups of all infants during supine lying, grouped by product type (A) infant carriers, (B) bouncers, (C) strollers, (D) rockers, (E) swings, and (F) infant floor seats. The black line represents the playmat, and all data was normalized to this value. \*p<0.05 vs. the playmat condition. .... 142

Figure 76. Bilateral mean ( $\pm$ standard error) EMG values for all muscle groups of infants < 4 months during supine lying, grouped by product type (A) infant carriers, (B) bouncers, (C) strollers, (D) rockers, (E) swings, and (F) infant floor seats. The black line represents the playmat, and all data was normalized to this value. \*p<0.05 vs. the playmat condition..... 143

Figure 77. Bilateral mean ( $\pm$ standard error) EMG values for all muscle groups of infants  $\geq$  4 months during supine lying, grouped by product type (A) infant carriers, (B) bouncers, (C) strollers, (D) rockers, (E) swings, and (F) infant floor seats. The black line represents the playmat, and all data was normalized to this value. \*p<0.05 vs. the playmat condition..... 144

Figure 78. Bilateral mean ( $\pm$ standard error) EMG values for cervical paraspinal (CP) muscles of infants during quiet supine lying in all conditions. The black line represents the playmat, and all data was normalized to this value. Top: data for all infants; Right: data for younger infants; and Left: data for older infants. \*p<0.05 vs. the playmat condition. .... 146

Figure 79. Bilateral mean ( $\pm$ standard error) EMG values for erector spinae (ES) muscles of infants during quiet supine lying in all conditions. The black line represents the playmat, and all data was normalized to this value. Top: data for all infants; Right: data for younger infants; and Left: data for older infants. \* $p < 0.05$  vs. the playmat condition. .... 147

Figure 80. Bilateral mean ( $\pm$ standard error) EMG values for abdominal (AB) muscles of infants during quiet supine lying in all conditions. The black line represents the playmat, and all data was normalized to this value. Top: data for all infants; Right: data for younger infants; and Left: data for older infants. \* $p < 0.05$  vs. the playmat condition. .... 148

Figure 81. Bilateral mean ( $\pm$ standard error) EMG values for quadriceps (QUAD) muscles of infants during quiet supine lying in all conditions. The black line represents the playmat, and all data was normalized to this value. Top: data for all infants; Right: data for younger infants; and Left: data for older infants. \* $p < 0.05$  vs. the playmat condition. .... 149

Figure 82. Bilateral mean ( $\pm$ standard error) EMG values for all muscle groups of all infants during supine quiet lying, grouped by product type (A) infant carriers, (B) bouncers, (C) strollers, (D) rockers, (E) swings, and (F) infant floor seats. The black line represents the playmat, and all data was normalized to this value. \* $p < 0.05$  vs. the playmat condition. .... 150

Figure 83. Bilateral mean ( $\pm$ standard error) EMG values for all muscle groups of younger infants during supine quiet lying, grouped by product type (A) infant carriers, (B) bouncers, (C) strollers, (D) rockers, (E) swings, and (F) infant floor seats. The black line represents the playmat, and all data was normalized to this value. \* $p < 0.05$  vs. the playmat condition. .... 151

Figure 84. Bilateral mean ( $\pm$ standard error) EMG values for all muscle groups of older infants during supine quiet lying, grouped by product type (A) infant carriers, (B) bouncers, (C) strollers, (D) rockers, (E) swings, and (F) infant floor seats. The black line represents the playmat, and all data was normalized to this value. \* $p < 0.05$  vs. the playmat condition. .... 152

Figure 85. Bilateral mean ( $\pm$ standard error) EMG values for cervical paraspinal (CP) muscles of infants during prone lying in all conditions. The black line represents the playmat, and all data was normalized to this value. Top: data for all infants; Right: data for younger infants; and Left: data for older infants. \* $p < 0.05$  vs. the playmat condition. .... 154

Figure 86. Bilateral mean ( $\pm$ standard error) EMG values for erector spinae (ES) muscles of infants during prone lying in all conditions. The black line represents the playmat, and all data was normalized to this value. Top: data for all infants; Right: data for younger infants; and Left: data for older infants. \* $p < 0.05$  vs. the playmat condition. .... 155

Figure 87. Bilateral mean ( $\pm$ standard error) EMG values for abdominal (AB) muscles of infants during prone lying in all conditions. The black line represents the playmat, and all data was normalized to this value. Top: data for all infants; Right: data for younger infants; and Left: data for older infants. \* $p < 0.05$  vs. the playmat condition. .... 156



Figure 88. Bilateral mean ( $\pm$ standard error) EMG values for quadriceps (QUAD)) muscles of infants during prone lying in all conditions. The black line represents the playmat, and all data was normalized to this value. Top: data for all infants; Right: data for younger infants; and Left: data for older infants. \* $p < 0.05$  vs. the playmat condition. .... 157

Figure 89. Bilateral mean ( $\pm$ standard error) EMG values for all muscle groups of all infants during prone lying, grouped by product type (A) infant carriers, (B) bouncers, (C) rockers, and (D) swings. The black line represents the playmat, and all data was normalized to this value. \* $p < 0.05$  vs. the playmat condition. .... 158

Figure 90. Bilateral mean ( $\pm$ standard error) EMG values for all muscle groups of younger infants during prone lying, grouped by product type (A) infant carriers, (B) bouncers, (C) rockers, and (D) swings. The black line represents the playmat, and all data was normalized to this value. \* $p < 0.05$  vs. the playmat condition. .... 159

Figure 91. Bilateral mean ( $\pm$ standard error) EMG values for all muscle groups of older infants during prone lying, grouped by product type (A) infant carriers, (B) bouncers, (C) rockers, and (D) swings. The black line represents the playmat, and all data was normalized to this value. \* $p < 0.05$  vs. the playmat condition. .... 160

Figure 92. Relationship between seatback incline of seated products and the average head/neck angle of the infants in our in vivo biomechanics study. .... 162

Figure 93. Three-dimensional renderings of the (Top) newborn-sized five segment sagittal plane device, and (Bottom) infant-sized (three-month old) five segment sagittal plane device. .... 178

Figure 94. Newborn-sized five-segment sagittal plane device assembly drawing. .... 179

Figure 95. Infant-sized (3 month old) five-segment sagittal plane device assembly drawing. .... 180

Figure 96. Example positioning of the five segment sagittal plane device in infant carrier S06 in (A) the intended position, and (B) the slouched position. .... 181

Figure 97. Example of torso-pelvis, trunk flexion, and head-neck flexion measured by the five-segment sagittal plane device in infant carrier S06. We also measured hip flexion as the angle between the pelvis and leg segments, though no corresponding human subjects data is available. .... 182

Figure 98. Motion capture kinematic data from human subjects study (red lines) compared to different sagittal plane devices in the infant carrier (S06). .... 186

Figure 99. Motion capture kinematic data from human subjects study (red lines) compared to different sagittal plane devices in the bouncer (S12). .... 186

Figure 100. Motion capture kinematic data from human subjects study (red lines) compared to different sagittal plane devices in the stroller (S17). .... 187

Figure 101. Motion capture kinematic data from human subjects study (red lines) compared to different sagittal plane devices in the rocker (S16). .....	187
Figure 102. Motion capture kinematic data from human subjects study (red lines) compared to different sagittal plane devices in the swing (S24). .....	188
Figure 103. Sensitivity analysis showing how small deviations from the intended position may influence results for (top) S24 and (bottom) S17. ....	189
Figure 104. Results from sensitivity testing for (left) S24 and (right) S17. ....	190
Figure 105. Sagittal plane kinematics for all infant carriers, presented with the center of rotation between the pelvis and leg sections coinciding for all infant carrier products. ....	191
Figure 106. Sagittal plane kinematics for all bouncers, presented with the center of rotation between the pelvis and leg sections coinciding for all products.....	192
Figure 107. Sagittal plane kinematics for all strollers, presented with the center of rotation between the pelvis and leg sections coinciding for all products.....	193
Figure 108. Sagittal plane kinematics for all rockers, presented with the center of rotation between the pelvis and leg sections coinciding for all products.....	194
Figure 109. Sagittal plane kinematics for all swings, presented with the center of rotation between the pelvis and leg sections coinciding for all products.....	195
Figure 110. Example of the five-segment sagittal plane device not performing well in an upright infant floor seat product. ....	196
Figure 111. Photos of the five-segment sagittal plane devices with preliminary three-dimensional head geometry modeled as a hemisphere with $1/3^{\text{rd}}$ of the diameter height. ....	197

## List of Tables

Table 1. Description of measurements and notes.....	35
Table 2. Dimensions of all products.....	37
Table 3. Back and thigh incline angle measurements taken using the infant-sized hinged weight gauge and a digital inclinometer in each product (all in degrees). Note that the infant floor seat products could not be tested using this method due to the designs preventing the device to correctly sit in the product. ....	38
Table 4. Product details for infant carriers, bouncers, and strollers. ....	41
Table 5. Product details for rockers, swings, and infant floor seats. ....	42
Table 6. Marketed use and other notes for infant carriers, bouncers, and strollers. ....	43
Table 7. Marketed use and other notes for rockers, swings, and infant floor seats. ....	44
Table 8. Warning label language for infant carriers and bouncers.....	51
Table 9. Warning label language for strollers and rockers. ....	52
Table 10. Warning label language for swings and infant floor seats. ....	53
Table 11. Table of seat width and base width values, and a ratio, where a ratio of >1 means the seat is wider than the base, and a ratio of <1 means the base is wider than the seat. ....	54
Table 12. Results of head rotation testing on all 24 products. ....	62
Table 13. Concavity and conformity testing results for all products in the unweighted and weighted conditions in the head position, with the larger $\Delta r$ values representing more conformity. ....	74
Table 14. Concavity and conformity testing results for all products in the unweighted and weighted conditions in the seat position, with the larger $\Delta r$ values representing more conformity. ....	74
Table 15. Combined data from head rotation testing and the concavity measurement ( $r$ ) from the weighted condition. ....	75
Table 16. Demographic data from the infants tested in the human subjects study. ....	113
Table 17. Numbers of infants who completed each testing condition.....	113
Table 18. Median and quartile data for the quiet lying data.....	130
Table 19. Anthropometric newborn and infant (3 month old) measurements for five segment sagittal plane devices.....	177

Table 20. Sagittal plane testing results for each product with the newborn sized device in the intended position. .... 183

Table 21. Sagittal plane testing results for each product with the newborn device in the slouched position. .... 184

Table 22. Sagittal plane testing results for each product with the infant device in the intended position. .... 185

Table 23. Sagittal plane testing results for each product with the infant device in the slouched position. .... 185

## Abbreviations

AS/NZS	Australian Standard / New Zealand Standard
ASTM	ASTM International
BS	British Standard
CO <sub>2</sub>	Carbon dioxide
CPSC	Consumer Product Safety Commission
EMG	Electromyography
H <sub>2</sub> O	Water
IDI	In-Depth Investigation
NREM	Non-rapid eye movement
O <sub>2</sub>	Oxygen
PIRCM	Paradoxical inward rib cage movement
PO <sub>2</sub>	Partial pressure of oxygen
REM	Rapid eye movement
SpO <sub>2</sub>	Oxygen saturation

## 1. Introduction and Report Overview

According to a U.S. Consumer Product Safety Commission (CPSC) report titled “Injuries and Deaths Associated with Nursery Products Among Children Younger than Age Five” (Yang, 2022), between 2017 and 2019, 38 deaths were associated with infant carriers, 11 deaths involved bouncer seats, and 3 deaths were associated with strollers/carriages, and 3 deaths were associated with rockers. Some of these deaths occurred because infants were left unsupervised for an extended period of time, usually for sleep or nap. CPSC staff is interested in identifying the factors that make these products hazardous for infants to sleep or nap and how these factors may differ or resemble infant sleep products. The current study will identify product characteristics that make these products hazardous.

The overall purpose of this research is to analyze the death or injury risks and potential benefits to infants associated with seated products such as bouncers, swings, rockers, strollers, carriers, and floor seats (hereafter referred to as “seated products”) in foreseeable product positions and foreseeable infant body and face positions.

Our research team includes the Principal Investigator, Dr. Erin Mannen, who has a Ph.D. in mechanical engineering with research expertise in infant biomechanics; Dr. John Carroll, who is a research-active pediatric pulmonologist; Dr. Brandi Whitaker, who is a pediatric psychologist with expertise in infant development; Dr. Trevor Lujan who has a Ph.D. in mechanical engineering with expertise in mechanical testing; Chris Wilson who has expertise in biomechanical testing; graduate research assistants Danielle Siegel and Sarah Goldrod, and undergraduate research assistant Andrew Bossart.

Our team conducted research to analyze the death or injury risk during unattended sleeping as well as benefits to infants associated with attended awake time in a range of seated products. In [section 2](#), we reviewed 47 in-depth investigations (IDIs) and determined that a range of factors contribute to deaths in seated products, including: (1) suffocation related to occlusion, airflow resistance, and/or an abnormal exchange of gases, meaning the nose or mouth is occluded by contact with the product or the infant’s face is in contact or near contact with a product that resists free airflow and/or promotes higher levels of carbon dioxide (CO<sub>2</sub>) and/or lower levels of oxygen (O<sub>2</sub>); (2) positional asphyxia related to the body position of an infant within the product that inhibits normal breathing, particularly a chin-to-chest position featuring head-neck flexion or a slouched position featuring trunk flexion. In this research

study, we have explored these hazard types by designing and conducting tests to measure product characteristics that could contribute to an increased risk of suffocation or positional asphyxia.

In section 3, we characterized a selection of four products in each seated product category, including basic dimensional and material observations, design features, and warning labels. In sections 4 and 5 we developed new methods and performed testing to quantify the concavity and conformity of seated products to understand if product features promote or restrict mouth/nose contact with the sides of products. In section 6, we designed a handheld test device and performed firmness testing to understand how the features of products may promote or inhibit an infant's face from becoming enveloped by soft goods that could decrease airflow or result in an abnormal exchange of gases during breathing. In section 7, we performed airflow testing to quantify how the seated products allow for or resist airflow. In section 8, we performed an *in vivo* human subjects biomechanical experiment to understand how infants bodies are positioned within the seated products, how they move, and how they use their muscles in order to elucidate risk of suffocation from movement, body position, and/or mouth/nose contact with the product. We assessed kinematics (head-neck flexion, trunk flexion, and torso-pelvis flexion) in supine and prone positions to determine risks during intended placement and in the case of an infant who rolled over in the product. The human subjects data was also assessed to understand potential benefits related to musculoskeletal or motor development in infants. In section 9, we developed a five-segment sagittal plane positional measurement tool to measure body position in a test lab setting, and then compared our results to the human subjects data from section 8. Finally, in section 10, we provide a short summary with key recommendations. A schematic of our experimental process is detailed in **Figure 1**.

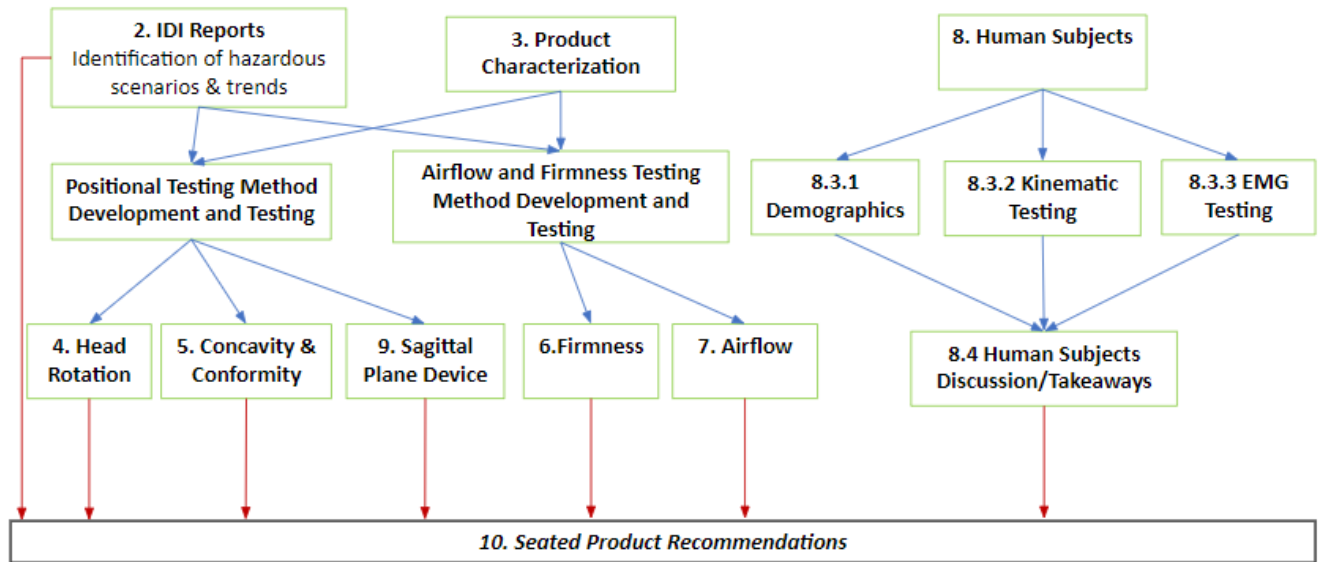


Figure 1. Schematic of overall research plan and report structure.



## 2. In-Depth Investigations

### 2.1 In-Depth Investigation Overview

The CPSC staff provided our team with 47 In-Depth Investigation (IDI) packets which involved injuries or deaths of infants when one of the above identified seated products was present. Each IDI packet contained portions of the following information: police reports, medical records and health information, EMT reports, coroner reports, medical examiner reports, toxicology or laboratory reports, autopsy reports, forensic investigations, parental or caregiver statements, photos of the scene, photos of the infant or child, photos of the products involved, detailed information of the products involved, any related product recall information, product purchase information, correspondence from the CPSC to others seeking information regarding the incident, source documentation, and a CPSC staff summary of the investigation. The incidents spanned from April 2010 to February 2022. The purpose of this section was to summarize the IDI data into a narrative summary of all of the IDIs we were provided.

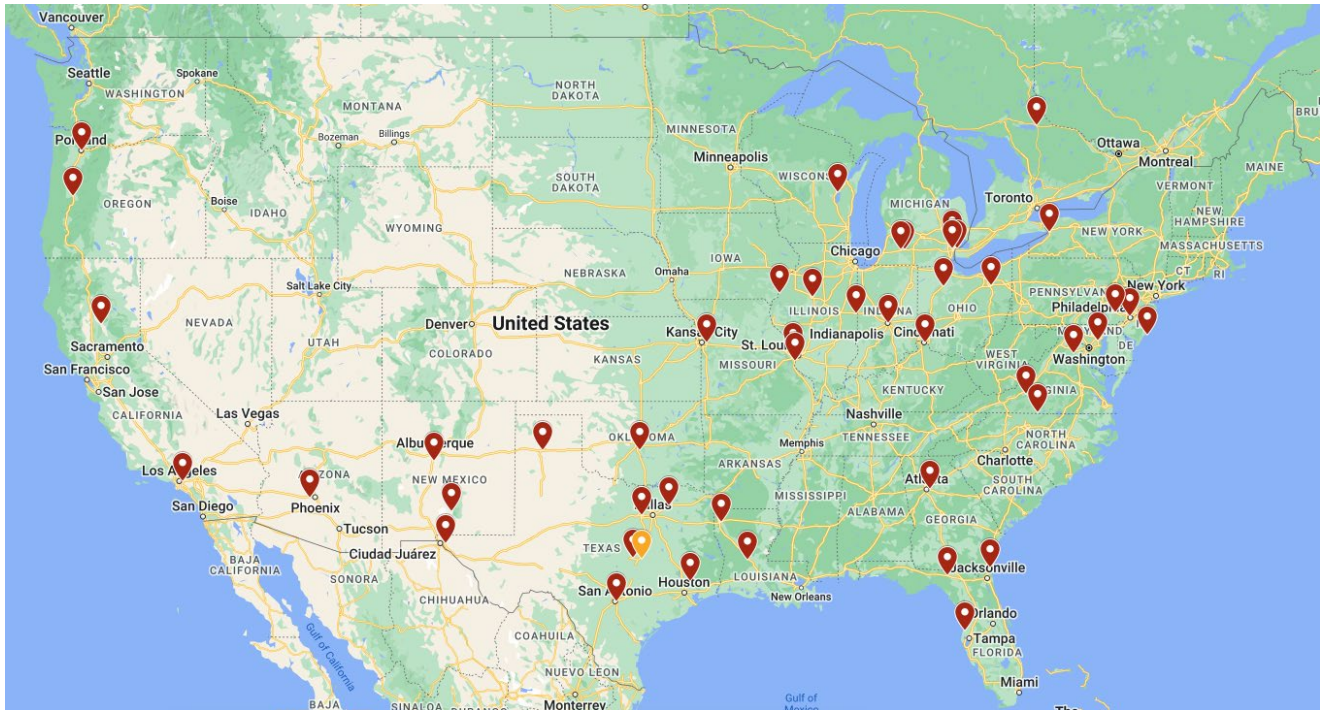
## 2.2 In-Depth Investigation Methods

Drs. Carroll, Mannen, and Whitaker individually reviewed each IDI and provided a short interpretation of the incident. The CPSC staff summaries of the incidents were not considered in our own reviews. We assessed the contribution of the seated product to each incident by asking the question “What is the likelihood that this incident would have occurred had the seated product not been involved?” Although each investigator reviewed every IDI packet independently, we each have complementary expertise that allowed us to assess the role of the seated product in the incidents with specific considerations in mind: Dr. Carroll focused on respiratory compromise related to the seated product and medical condition or clinical status of the infants which would increase physiological vulnerability; Dr. Mannen focused on body position and movement-related characteristics of the incidents; and Dr. Whitaker focused on developmental considerations of the infants. We chose not to average our scores but rather have all three individual scores to show how our decisions were made based on our own expertise.

Based on our individual interpretations of the IDIs, we each scored every incident on a Likert scale from 1 to 5, with “1” meaning the seated product was *very unlikely* to have contributed to the incident, “2” meaning *unlikely*, “3” meaning *neutral*, “4” meaning *likely*, and “5” meaning the seated product was *very likely* to have contributed to the incident. A score of “0” indicated there was *not enough information* in the IDI packet to make a judgment on the contribution of the seated product to the reported incident. We did not indicate whether the seated product was the primary cause of the incident, only if the seated product likely contributed to the incident. After the preliminary independent reviews, if two of the three investigators scored the incident a 4 or 5, the incident was considered for further analysis regarding the seated product’s probable role in the incident. There was no statistical difference between the scores of the three raters (mean values Carroll: 4.1; Whitaker: 3.9; Mannen: 4.1; paired t-tests;  $p > 0.05$ ).

## 2.3 In-Depth Investigations Results and Discussion

**Figure 2** shows the geographic distribution of the 47 incidents. Of the 47 incidents, 46 were deaths and 1 was an injury. Incidents were reported from 21 states and 1 incident in Canada, in a mix of rural and metropolitan areas.



**Figure 2.** Map of the continental United States showing locations of all 47 IDs reviewed, where a red pin represents a death and a yellow pin represents an injury.

**Figure 3** shows a flow chart of our IDI review and analysis process. Of the 47 IDs provided to the team, 46 were classified as deaths while 1 was an injury. Of the 47 IDs, 4 IDs did not contain enough information (all in the rocker category) to make an assessment, and 4 were assessed that the seated product did not likely contribute to the death (*i.e.*, all three investigators scored the incident 3 or lower; 3 rockers, 1 swing). After further examination of the scores, we determined to include cases for further analysis where 2 of the 3 reviewers scored the incident a 4 or 5. This resulted in 3 additional swings, 1 bouncer, and 1 rocker incident being excluded from further analysis. Medical vulnerability, either due to cases where the infant was ill or had a chronic condition, did not change our scoring except in a single swing incident where scores were reduced by 1 point for one reviewer. Thus, 33 incidents remained which we explored in more detail and categorized into four scenarios per product category: positional asphyxia, suffocation, product tipping, and other. Positional asphyxia scenarios resulting from body

positions of head-neck flexion and/or a slouched trunk accounted for 9 of the IDIs, with 8 of the incidents occurring when infants were chin-to-chest when in the seated position and 1 of the incidents occurring when a baby pushed back on the product resulting in neck hyperextension. Suffocation scenarios include an abnormal exchange of gases (increased CO<sub>2</sub>, decreased O<sub>2</sub>, or a combination of both), airflow resistance, and nasal occlusion (see section 4.1 for a more robust discussion) accounted for 14 IDIs, with some incidents occurring when the infant's face was found in contact with the side of the seated product or found prone with the face in contact with the product. Product tipping (or tip-overs) occurred in 5 instances, with 4 of the incidents occurring when products were placed in an environment where the seated product was placed on top of another sleeping product (e.g., adult bed, air mattress). Five IDIs occurred under Other circumstances with all of those incidents identified as strangulation when infants were caught in the buckle straps and 1 when the infant "scoted" out of the seat and was trapped between the plastic tray and seat.

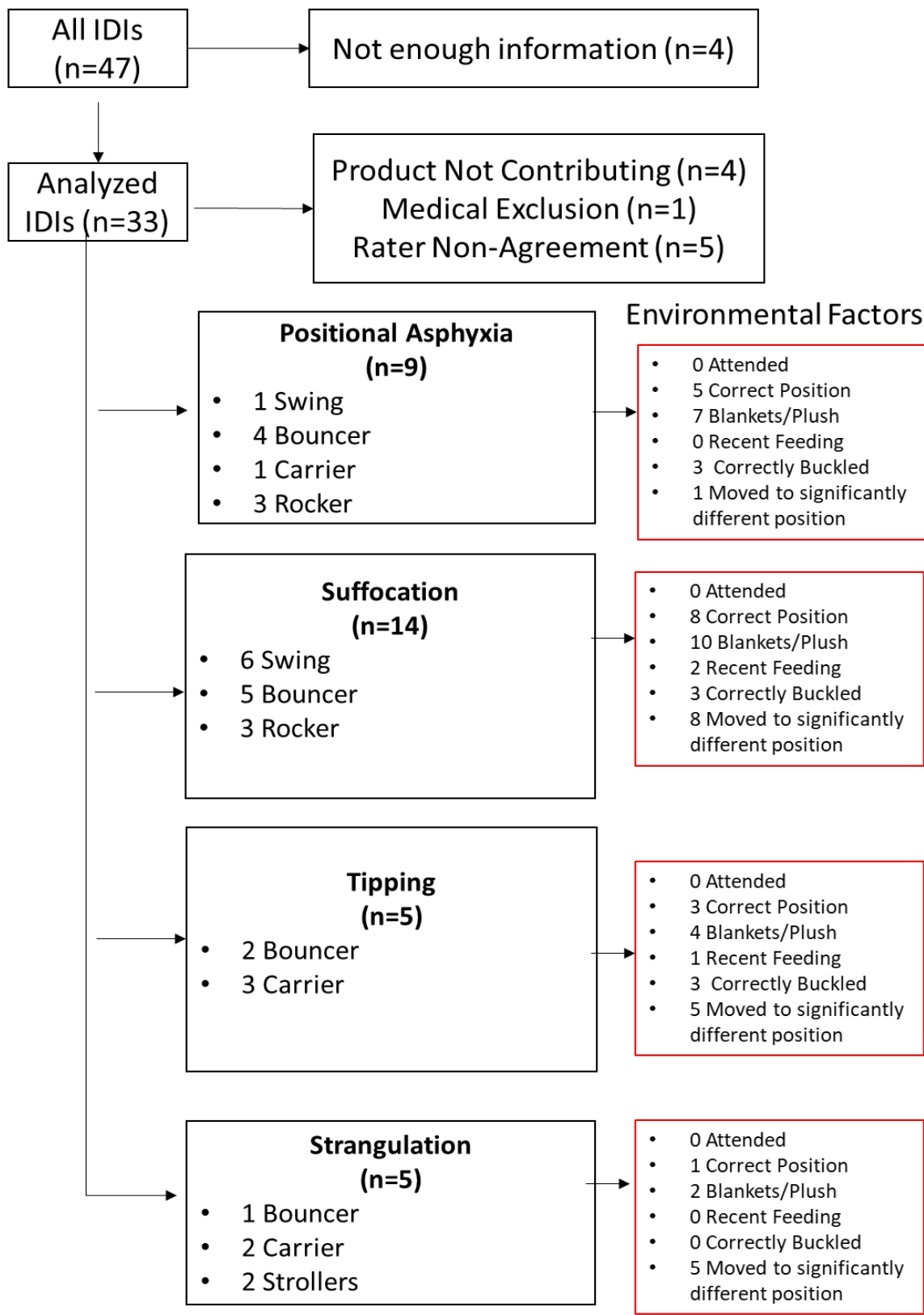


Figure 3. Flowchart of IDIs broken down by hazard type.

Several of these scenarios resulted from infant movement, so we chose not to include movement as its own category since movement was present in many incidents across all hazard categories. When infants were placed supine in the intended position, they were found in various positions – head hyperextended over the top of the product, slouched in the seat of the product, side-lying or prone position within the product, and hanging from the product after tipping are some examples.

The demographics of the infants involved in the 33 incidents where the seated product contributed to the incident are: *Age*:  $4.1 \pm 3.6$  months [range: 2 days to 14.9 months]; *Sex*: 14 female / 19 male; and *Race/ethnicity*: 18 white, 9 black/African-American, 3 Hispanic, 3 other/multi-racial/unknown. There was significant variability in infant age ranges in products:

Bouncers: *Age*:  $3.5 \pm 2.7$  months [range: 0.2 to 10.2 months]

Carriers: *Age*:  $8.8 \pm 4.9$  months [range: 3.6 to 14.9 months]

Rockers: *Age*:  $2.3 \pm 1.4$  months [range: 0.1 to 4.0 months]

Strollers: *Age*:  $5.7 \pm 0.1$  months [range: 5.6 to 5.8 months]

Swings: *Age*:  $2.6 \pm 1.5$  months [range: 1.0 to 5.3 months].

Four infants were reportedly pre-term (gestational age < 37 weeks), 4 had chronic health conditions which were not considered to be the cause of death, and 6 infants had a current illness (low-grade fever, congestion, fussiness, etc.). Three of the cases involved infants between 11 and 15 months of age, 1 of which was noted to have developmental delays. A few parents of the infants stated they placed their infant at an inclined angle at the suggestion of the infant's doctor to help with reflux, especially for the swings (3 incidents). All incidents occurred when an infant was asleep in the seated product. Specifically, 23 instances identified the seated product as the typical sleeping location or the intended sleeping environment at the time of the incident, 4 caregivers noted using the device for sleep to keep their infant's head elevated, and 3 reports indicated there was no crib or other safe sleep environment in the home. The one injury case noted the infant was placed in the product for a nap and the caregiver heard noises, then returned and found the infant not breathing with the infant quickly recovering after being taken out of the product. **Figure 4** shows a breakdown of the IDIs with respect to the product category.

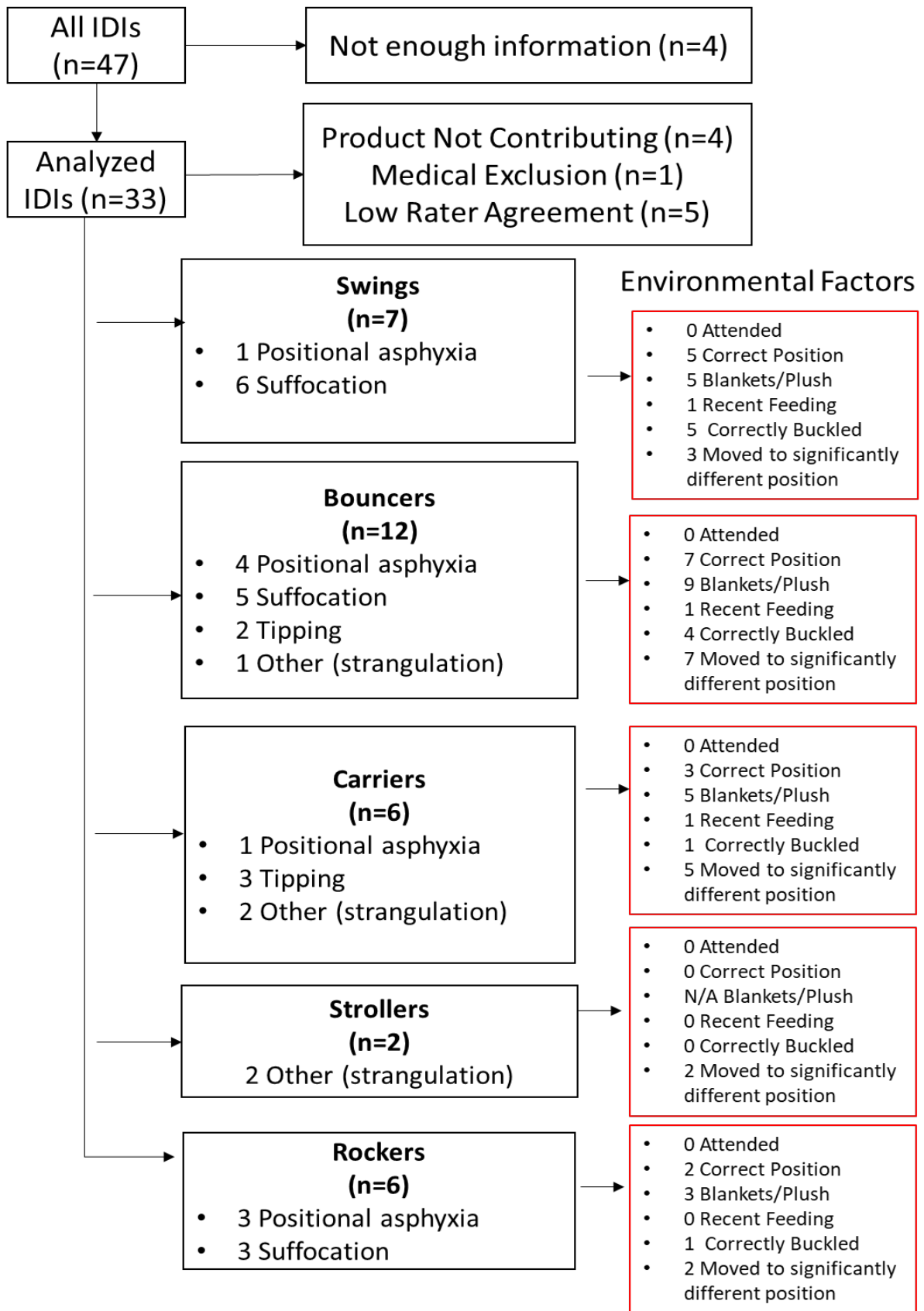


Figure 4. Flow chart of IDI characterizations.

Positional asphyxiation scenarios accounted for 9 of the IDIs, with 8 of the incidents occurring when infants slouched down in a seated position resulting in a flexed trunk and/or flexed head-neck position (with the extreme head-neck flexion considered to be a chin-to-chest position), and 1 of the incidents occurred when an infant pushed back on the product resulting in neck hyperextension. These cases included the youngest infants of all product categories, with the youngest being 2 days, being placed in the product and found chin-to-chest. In 3 of these cases, the infants were properly buckled and placed supine, in the intended positions. However, the infants were found “slumped,” and in 2 of the cases the medical examiner noted infants would not have had proper tone to maintain open airways when placed in the intended position. Additionally, in 2 cases, the product was noted to be in the “toddler-setting”, presumably more upright, increasing the likelihood a newborn would be found chin-to-chest.

Suffocation scenarios accounted for 14 IDIs, with 11 incidents occurring when the baby’s face was found in contact with the side or surface of the product after rolling from supine to side-lying or prone, and 3 incidents occurring when babies were placed side-lying or prone and found prone with their face in contact with the product. Of these 3 incidents, there were 2 involving bouncers where the infant either rolled out of the product, or the product tipped over, resulting in the infant’s face being against an adult mattress, the seated product, or other plush materials. There were no suffocation incidents for the carriers or strollers.

Product tipping or tip-over scenarios accounted for 5 IDIs, with 4 of the incidents occurring when products were placed on top of another sleeping product (e.g., adult mattress, air mattress). Product tipping was reported in 2 bouncer incidents and 3 carrier incidents. In all cases of tipping, the seated product was noted to be the primary sleeping device. In 3 of the cases the infant was noted to be properly buckled and in the intended position initially, and later found trapped as a result of the tipping. Of note, swings and strollers were not noted to have tipping instances (in all of the 43 incidents with enough information to determine scenario details) which may be a result of wider bases and more stable designs. These products were also reportedly not placed on other sleeping surfaces, likely due to their design.

IDIs classified under Other (strangulation) included 5 instances (2 carrier, 2 stroller, 1 bouncer) of which all 5 were the result of strangulation, with 1 of those 5 incidents occurring in a recalled stroller product due to entrapment between the seat and the plastic tray. In all 5 of these, none of the infants were buckled and only 1 was placed in the correct position.



Infants were most commonly placed in the seated product unrestrained or improperly restrained, with additional blankets, and unattended. In the majority of incidents, the seated product was part of an overall hazardous environment for sleep. The team noted the following situations in each incident: unattended, unrestrained, unintended position, blankets present, other plush items present, and fed prior to or while in seated product. Five scenarios included the seated product being placed atop another product, most commonly an adult mattress, but also in cribs or on tables. Additionally, there were 12 instances of when the infant was not placed correctly on his/her back within the seated product, 7 where other plush objects were present, and 22 where blankets were present. We also noted many situations where an infant had moved from the position they were placed.

**Unattended:** In all 33 incidents, infants were left unattended in the seated product when the incident occurred. In some cases, caregivers were in the same room but were not attending to the infant because they were also asleep. There were 6 cases noted with the infant being placed in a separate room, in the seated product, specifically to nap in a quiet area.

**Unrestrained:** Infants were noted to be placed unrestrained or incorrectly restrained (meaning not all buckles were clipped) in the seated product in 21 incidents, restrained correctly in 11 incidents, and unspecified in 1 incident. Some infants were unrestrained due to the swaddle not allowing for restraint use, or because a blanket had been placed to line the product, covering the restraint. Of note, the 5 incidents of strangulation were all when the infants were unrestrained, and in 4 of the incidents, the infant was entangled in the straps. In the other case, the infant had moved from the placed position, entrapping the infant's head between the seat and plastic parts on the seated product.

**Unintended position:** Infants were placed in the intended position (meaning the baby had the correct body position within the product and/or location or configuration of the product) in 21 of the 33 incidents. In 4 incidents, infants were placed on their sides, 2 in configurations of the product meant for older children, 1 placed prone, and 5 were unknown. This information was not specified in 7 incidents. Infants as young as 2 days old were noted to roll, scoot and slide into positions resulting in them falling out of the product (3 incidents; does not include tipping) or being found prone (14 incidents). Infants were more likely to be placed on their sides in the swings and rockers compared to other product categories.

**Blankets:** Blankets or swaddle blankets were mentioned in 22 incidents, were not present in 3 incidents, and were not specified in 5 incidents. Blankets were used to cover the infant's legs, to cover

the seated product such that the infant was lying on the blanket, or for other reasons. In none of these incidents was a blanket deemed to be the primary contributor to the death or injury. In 5 of the 22 incidents with blankets noted, the infant was noted to be properly buckled.

**Other plush products:** Other plush products such as pillows, stuffed animals or towels were mentioned in 7 incidents, were not present in 4 incidents, and were not specified in 22 incidents. In none of these 33 incidents was the other plush product deemed to be the primary contributor to the death or injury. In the bouncers and rockers, towels were noted to help “prop” the infant up or to support the infant when placed on his/her side in 3 incidents. There were additional cases when thick plush blankets were noted on top of the infant.

**Feeding:** Most incidents did not mention feeding. However, 3 incidents noted that infants were fed prior to being placed in the seated product. There are reports for the swing and bouncer products that caregivers noted physicians recommended the infant sleep in the product to help with reflux.

**Movement:** Twenty, or nearly two-thirds of the incidents we reviewed were of infants younger than 3 months. Of these, 10 infants were noted to have rolled, slouched or “scooted” down in the product. It is unlikely infants this young would have the developmental control or muscle tone to move themselves into or correct themselves from these positions without a mechanical advantage from the product. Additionally, 2 infants were noted to be in the toddler-setting of the seated product (rocker), which resulted in the chin-to-chest position. Four of the 5 cases involving strangulation noted that the infants moved in the product; none were buckled properly. In the remaining strangulation case, the infant was 3.9 months of age and was noted to have slid between the seat and plastic tray.

The incident analysis elucidated the hazardous environments with many incidents having blankets or other plush products in the sleep area. Yet, statements from caregivers in several of the reports directly note caregivers used the seated product in an attempt to increase safety either for infants who were sick or not able to sleep in a crib or bassinet because one was not available.

Another striking finding was the seated product facilitating the movement of very young infants, which enabled supine to prone rolling of infants as young as 1 month. There were 6 incidents of infants between 4 to 9 weeks of age noted to roll, which is developmentally unlikely without the added leverage from body positioning caused by the product. For infants over 3 months, some statements from caregivers indicated their infants could not yet roll over nor move to another location on his/her own. In many of these incidents, the seated product was not the direct cause of death but instead

facilitated the infant to move into a hazardous position that otherwise would have been unlikely based on their developmental stage. Similar to our previous research on infant inclined sleep products (Wang et al., 2021), infant pillow products (Mannen et al., 2022), and within inclined environments (Siegel et al., 2023), the seated products represent a very different mechanical environment than a firm flat crib mattress, so coordination to achieve various movements is different within the seated product environment than it is on a firm flat surface. In some cases, the seated products facilitated rolling or unusual movements of younger infants, entrapping them in a hazardous position which resulted in either their face being covered or the infant falling off other products or surfaces onto which the seated products were placed (e.g., beds). Some reports indicated caregivers used blankets and other items (e.g., towels, additional pillows) to “prop-up” the infant to help avoid rolling or to keep bottles near the infants’ mouth to allow for self-feeding.

Prematurity and underlying health issues may also contribute to these incidents, though our team did not determine them to be a primary cause of the 33 incidents. Eleven infants had health considerations including 4 born premature (<37 weeks gestation), 2 twin births, 1 with a cardiac or pulmonary condition, and 6 with congestion and/or a known respiratory infection within days of the incident. A few IDIs included statements either directly from a caregiver or investigator indicating caregivers were influenced by healthcare professionals, friends and family, or advertisements to prop the baby up for sleep to alleviate acid reflux, congestion and to aid with opening the airways for more comfortable breathing.

We found some similarities and differences between product categories. All of the incidents which occurred in a swing occurred in swings from the same manufacturer, and of these, all which had photos included showed a plush pillow feature. Pillows are a well-known suffocation hazard for infants.

## 2.4 In-Depth Investigations Conclusions

Based on our review of the IDIs and our team's experience and expertise, we recommend that discharge information from hospitals and infant well-child visits include guidance on unsafe use of infant seated products for sleep or unattended awake time. Despite there being a vast body of literature available to caregivers regarding safe sleep practices and manufacturer warnings regarding seated products, caregivers continue to use these products for sleep, creating unsafe environments. As noted in the IDIs, caregivers are sometimes using these products at the recommendation or suggestion of physicians and other allied health care providers to reduce reflux and/or congestion. We note that some hospitals use seated products for infants in the NICU while their vital signs are monitored, but parents may wrongly assume that unattended use of these same products in a home setting is safe. It will be imperative for medical staff to continue to address safe sleep practices, specifically by highlighting the dangers of using the seated products for nighttime sleep as well as daytime napping.

Seated products should not have plush pillow-like features which can cover an infant's face and introduce a suffocation hazard. Even when infants were noted to be buckled and placed supine in the IDIs, infants were noted to have their faces "smashed" into the plush sides, influencing normal breathing.

We also suggest that tip-over testing be performed on products on softer and less stable surfaces. Despite manufacturer warnings against placing these products on other products, it is still occurring, increasing the risk for entrapment, suffocation, and strangulation. Swings featured larger footprints and no tipping incidents occurred in the IDIs we reviewed within these products nor were they noted to have been placed on any surface besides the floor. Wider and more stable bases on all seated products would decrease the risk of tipping-related hazards.

Restraints should always be used with seated product use. Physicians and health care providers should follow-up with caregivers to discuss the safety as the seated product aided in infant movement leading to hazardous scenarios, with many infants left unrestrained in the products, resulting in strangulation and suffocation.

## 3. Product Selection, Characterization, and Measurement

### 3.1 Product Selection

Products were selected by the team to represent the breadth of the product category. We selected at least four products per product category (infant carriers, bouncers, strollers, rockers, swings, and infant floor seats). All products were in new condition and were purchased through online retailers by our team. We selected some products based on those that were commonly identified within IDI reports, specifically the S17 rocker and the S21 swing. We presented the products to the CPSC staff, and decided on four products per product category to include in our study which best represented a range of designs and a range of price points, resulting in a total of 24 products (**Figure 5** and **Figure 6**). The product names, model numbers, manufacturers, and other purchase related details are listed in **Appendix A**.

At the time of writing this report, we are aware of one product recall related to a loose restraint strap causing a non-occupant strangulation hazard for crawling infants. We received the repair piece and continued with inclusion of the product in our study since the hazard was not related to the occupant of the product.



Figure 5. Photos of the infant carriers, bouncers, and strollers chosen for this study, along with the sample numbers.





Figure 6. Photos of the rockers, swings, and infant floor seats chosen for this study along with the sample numbers.

### 3.2 Product Characterization Methods

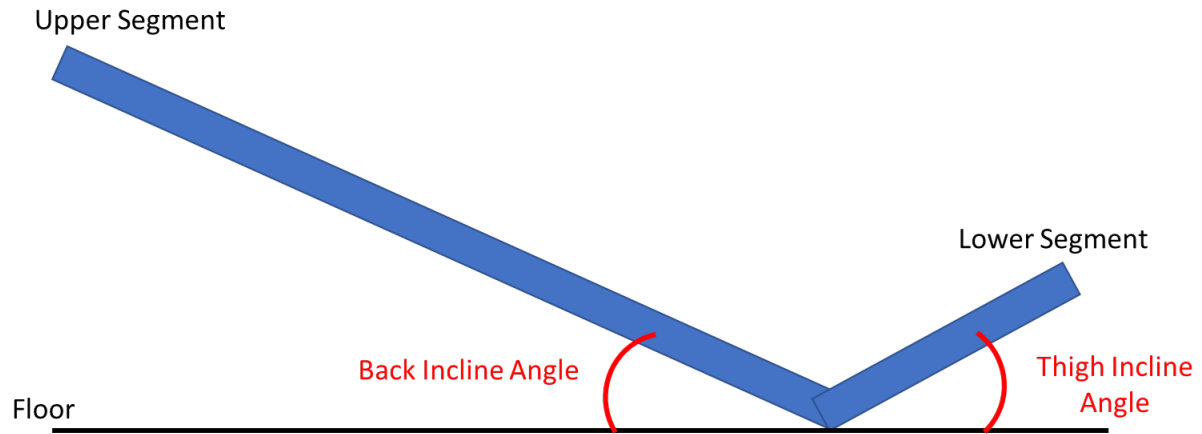
We took several measurements and observations of the products, as described in **Table 1**. Each numerical measurement was taken, and observational notes were recorded.

**Table 1.** Description of measurements and notes.

Measurement	Procedure
Mass (kg)	Placed on a mass scale and recorded value.
Height of Product (cm)	Used a tape measure and recorded value.
Baby Seat Height (cm)	Used a tape measure and recorded value.
Width of Product (cm)	Used a tape measure and recorded value.
Base Width of Product (cm)	Used a tape measure and recorded value.
Base Length of Product (cm)	Used a tape measure and recorded value.
Thickness (cm)	Used a tape measure and/or digital caliber and recorded value.
Warning Labels	Recorded all warning labels attached to the product.
Material	Recorded cover and filler materials on label.
Supine Sample	Material tested during the supine condition for airflow.
Prone Sample	Material tested during the prone condition for airflow.
Removeable Inserts	Recorded number of removeable inserts intended for small infants .
Marketed Use	The use that the product was marketed for was recorded.
Notes/Descriptive Text	Notes from the researchers were recorded.

We also recorded the seat back angle and thigh angle of each product, using the infant-sized hinged weight gauge as described in the ASTM standard ASTM F3118-17a Standard Consumer Safety Specification for Infant Inclined Sleep Products in order to compare these seated products to those in the inclined sleeper category of products that we previously researched (Mannen et al., 2019; Wang et al, 2021). For each product, we placed the infant-sized hinged weight gauge into the product with the hinge positioned just above the harness, and we took the back and thigh incline angle measurements using a digital inclinometer (Wixey, No. WR300). We repeated this process two more times, and then calculated the mean of the three trials. **Figure 7** shows a schematic of the measurement.





Back incline angle measure using the two-segment device

**Figure 7.** Schematic of measurements from infant-sized hinged weight gauge.

We took photos of the warning labels that were attached to the product via sewed in labels or tags. We qualitatively summarized common warnings and unusual features of each product category.

### 3.3 Product Characterization Results

Product dimensions are listed in **Table 2**.

**Table 2.** Dimensions of all products.

Category	Sample	Mass (kg)	Height of Product		Width of Product		Base Measures		Thickness		
			Max Height of Product (cm)	Baby Seat Height (cm)	Max. Width of Product (cm)	Max. Seat Width (cm)	Width (cm)	Length (cm)	Max. Insert Thickness (cm)	Max. Cover Thickness (cm)	Max. Pillow Thickness (cm)
Infant Carriers	S05	3.26	41.4	12.7	44.7	37.5	26.9	36.1	2.25	0.94	2.61
	S06	4.04	42	20	44.3	38.8	27.2	31.7	3.67	2.78	3.12
	S07	3.26	44.9	14.7	44.1	37.9	31.4	38.6	3.91	0.95	3.74
	S08	2.58	45.8	22.4	43.8	38	25.4	35.9	3.53	1.45	1.99
Bouncers	S09	3.18	51.3	20	34	35	38.9	79.3	N/A	6.9	N/A
	S10	7.03	46.1	16.9	70.3	53.1	67.9	60.6	4.26	5.3	5.98
	S11	3.06	56.6	18.5	50.6	43.5	45.6	46	N/A	1.96	4.03
	S12	3.44	67	24.7	57.9	58.3	54.9	35.6	2.64	1.58	2.32
Strollers	S13	9.97	106.2	52.8	62	40.3	56.4	52.6	N/A	1.02	N/A
	S14	10.06	98.9	70.9	62.6	38.1	59.8	61.5	4.26	1.97	3.44
	S15	11.43	97.8	47.1	52	40	57.2	66.4	N/A	3.78	N/A
	S16	5.35	98	38.4	43.1	34.4	42.4	49.2	N/A	1.85	N/A
Rocker	S17	2.29	60.1	18.4	51.9	45.2	52.4	52.6	N/A	2.34	N/A
	S18	6.8	82.2	29.4	51.4	42.4	47.5	43	N/A	1.89	N/A
	S19	4.98	86.2	55.3	63.3	41.3	63.5	83.3	6.41	12.6	5.02
	S20	2.52	47.9	10	40.3	39.3	39	60.4	3.24	5.8	N/A
Swings	S21	11.15	110.1	30.9	102.4	51	109.5	76	2.05	1.51	2.52
	S22	8.11	105.7	27.6	85.9	51.8	80.5	59	3.61	1.95	3.01
	S23	4.07	59.5	14.3	59.2	42.9	49.4	69.5	N/A	7.8	6.09
	S24	4.84	74.6	28.6	56.3	42.4	49.1	62.4	N/A	1.77	2.4
Infant Floor Seats	S25	1.35	24.1	0.2	37.1	37.4	36.4	44.1	N/A	10.8	N/A
	S26	1.97	31.1	10.3	43.8	33.2	43.1	55.8	N/A	1.06	N/A
	S28	2.56	38.1	8.9	50.4	37.6	49.9	50.7	N/A	1.13	N/A
	S29	1.28	21.2	0.4	54.3	54.2	41.4	34.1	N/A	22.6	N/A

Back and thigh incline angles are listed in **Table 3**. Photos of the infant-sized hinged weight gauge testing are presented in **Figure 8** and **Figure 9**.

**Table 3.** Back and thigh incline angle measurements taken using the infant-sized hinged weight gauge and a digital inclinometer in each product (all in degrees). Note that the infant floor seat products could not be tested using this method due to the designs preventing the device to correctly sit in the product.

Category	Sample Number	Trial 1		Trial 2		Trial 3		Average	
		<i>Back</i>	<i>Thigh</i>	<i>Back</i>	<i>Thigh</i>	<i>Back</i>	<i>Thigh</i>	<i>Back</i>	<i>Thigh</i>
Carriers	S05	31.2	53.2	30.8	51.8	30.6	55.5	30.9	53.5
	S06	35.6	43.2	36.2	43.6	35.2	43.2	35.7	43.3
	S07	25.2	38.8	36.2	35.7	36.0	36.7	32.5	37.1
	S08	22.0	38.9	22.5	41.0	21.2	43.2	21.9	41.0
Bouncers	S09	40.9	44.3	40.7	46.9	40.5	48.0	40.7	46.4
	S10	26.5	34.8	26.6	37.5	26.7	38.6	26.6	37.0
	S11	37.3	38.2	38.2	38.0	37.9	38.1	37.8	38.1
	S12	27.6	22.5	27.8	23.3	28.5	23.0	28.0	22.9
Strollers	S13	38.2	18.1	38.6	18.6	38.6	17.4	38.5	18.0
	S14	37.3	45.4	38.1	44.2	38.1	44.2	37.8	44.6
	S15	25.2	26.4	25.6	26.8	26.2	25.7	25.7	26.3
	S16	38.7	16.2	38.9	16.7	39.1	17.0	38.9	16.6
Rockers	S17	30.4	30.9	31.0	31.4	29.9	33.5	30.4	31.9
	S18	44.0	15.4	44.9	14.9	44.5	15.8	44.5	15.4
	S19	41.4	40.7	41.4	41.3	41.7	40.4	41.5	40.8
	S20	22.5	49.1	22.8	49.0	22.6	49.5	22.6	49.2
Swings	S21	36.2	47.4	35.9	50.9	36.9	51.2	36.3	49.8
	S22	32.8	48.5	32.2	48.7	33.1	52.2	32.7	49.8
	S23	28.2	52.5	28.9	53.1	29.3	53.2	28.8	52.9
	S24	24.8	42.4	24.9	44.6	25.5	44.9	25.1	44.0



Figure 8. Photos of testing with the infant-sized hinged weight gauge for infant carriers, bouncers, and strollers.



Figure 9. Photos of testing with the infant-sized hinged weight gauge for rockers and swings.



Product details including materials on the various areas of the products and removable inserts are listed in **Table 4** and **Table 5**.

**Table 4.** Product details for infant carriers, bouncers, and strollers.

Category	Sample	Material	Supine Sample	Prone Sample	Removeable Inserts
Infant Carriers	S05	Polyester	100% polyester	100% polyester	2
	S06	Seat pad: 68% polyester fiber batting, 20% polyurethane foam pad, 12% plastic stiffener. Body pillow: 85% polyurethane foam pad, 15% polyester fiber batting. Head pillow: 67% plastic stiffener, 20% polyurethane foam pad, 13% polyester fiber batting. Harness covers: 100% polyurethane foam pad. Buckle cover: 100% polyurethane foam pad.	68% polyester fiber batting, 20% PU foam pad, 12% plastic stiffener	Unknown	2
	S07	Seat pad: 66% polyurethane foam pad, 34% polyester fiber batting. Body pillow: 56% polyester fiber batting, 44% polyurethane foam pad. Head pillow: 91% polyurethane foam pad, 8% plastic stiffener, 1% polyester fiber batting.	66% PU foam pad, 34% polyester fiber batting	91% PU foam pad, 8% plastic stiffener, 1% polyester fiber batting	2
	S08	Body support: 81% polyester fiber, 19% polyurethane foam. Crotch pad: 100% polyester fiber. Harness covers: 100% polyester fiber. Head support: 56% polyester fiber, 44% polyurethane foam.	56% polyester fiber, 44% PU foam	56% polyester fiber, 44% PU foam	2
Bouncers	S09	Resinated polyester fiber batting 100%	100% resinated polyester fiber batting	100% resinated polyester fiber batting	0
	S10	Polyester fibers, polyurethane foam	Polyester fibers, PU foam (unknown concentrations)	Polyester fibers, PU foam (unknown concentrations)	1
	S11	100% resin-treated polyester fiber batting	100% resinated polyester fiber batting	100% resinated polyester fiber batting	1
	S12	Unknown	Unknown	Unknown	1
Strollers	S13	Seat pad: 72% polyester fiber, 26% polyurethane foam pad, 2% polyethylene foam pad. Shoulder pad: 100% polyester fiber. Basket: 100% polyurethane foam pad.	Unknown (potentially resinated polyester)	72% polyester fiber, 26% PU foam pad	0
	S14	Polyester	Polyester fibers	Polyester fibers	2
	S15	Body: 76% polyurethane foam pad and 24% olefin foam pad. Comfort pads (2); polyurethane foam pad 100%.	Unknown	76% PU foam pad, 24% olefin foam pad	0
	S16	100% polyester fiber batting	100% polyester fiber batting	100% polyester fiber batting	0

**Table 5.** Product details for rockers, swings, and infant floor seats.

Category	Sample	Material	Supine Sample	Prone Sample	Removeable Inserts
Rockers	S17	100% polyester fiber batting	100% polyester fiber batting	100% polyester fiber batting	0
	S18	100% polyester fiber batting	100% polyester fiber batting	100% polyester fiber batting	0
	S19	100% polyester	100% polyester	100% polyester	1
	S20	Insert pad: polyester fiber 100%, infant insert: polyester fiber 100%, toybar: polyethylene foam 100%	100% polyester fiber	100% polyester fiber	1
Swings	S21		Unknown (potentially polyester foam and batting)	Unknown	2
	S22	Seat pad, body support: 100% polyester fiber	100% polyester fiber	100% polyester fiber	1
	S23	100% resin-treated polyester fiber batting	100% resinated polyester fiber batting	100% resinated polyester fiber batting	1
	S24	Seat pad covering; outer 100% polyester, inner 100% polyethylene, and Backing 100% non woven polypropylene	Outer 100% polyester, inner 100% polyethylene	Unknown	1
Infant Floor Seats	S25	97% polyester fibers, 2% polyester fiber batting, 1% plastic film	97% polyester fibers, 2% polyester fiber batting, 1% plastic film	97% polyester fibers, 2% polyester fiber batting, 1% plastic film	0
	S26	100% polyester	100% polyester	100% polyester	0
	S28	100% polyester	100% polyester	100% polyester	0
	S29	100% polyester	100% polyester	100% polyester	0

Marketed use, other notes, and descriptive text are listed in **Table 6** and **Table 7**.

**Table 6.** Marketed use and other notes for infant carriers, bouncers, and strollers.

Category	Sample	Marketed Use	Other Notes/Descriptive Text
Infant Carriers	S05	Car seat, compatible with brand specific stroller, supports infants from 4 - 35 lb and 18 - 32"	Machine washable fabrics, includes adjustable base with 4 reclining positions
	S06	Car seat, compatible with some strollers, supports infants 4 - 30 lbs, and up to 32"	Machine washable fabrics, includes a base and an anti-rotation stability leg on the base, inserts for proper fit of babies as small as 4 pounds
	S07	Car seat, compatible with all strollers that feature QuickClick, supports infants 4 - 30 lbs and up to 32"	Machine washable fabrics, 4 harness heights spaced for a better fit from tiny to tall
	S08	Car seat, compatible with brand specific stroller, supports infants from 4 - 35 lb and 18 - 32"	Steel-reinforced base
Bouncers	S09	Bouncer, 3-point harness, newborn to 2 years of age, 8 - 29 lb	Not very plush, machine washable, when child can sit without help the bouncer can be used as a chair
	S10	Bouncer, sway, three recline positions, eating, play time, use built-in 3-point harness from birth until the child can sit upright or can climb out unassisted (around 5 months), use without built-in harness as a chair when child is able to walk, and discontinue when child reaches 130 lbs	Seat pad removes and evolves to big kid size, toy attachment
	S11	Bouncer, removable headrest as baby grows, 3-point harness, 0-6 months	Washable design, removable headrest, toy attachment
	S12	Bouncer, play, relax, newborn insert and supportive head rest, 3-point harness, 3-20 lbs	Machine washable, toy attachment
Strollers	S13	Stroller, bassinet mode, toddler front facing seat, car seat carrier (car seat sold separately), infant to toddler	One-hand fold, height adjustable seat, 4 wheels, removeable cover
	S14	Stroller with car seat, infant to toddler	4 wheels, carseat, removeable cover
	S15	Jogging stroller, all terrain, birth to 75 lbs.	Adjustable recline, 2 step fold, 3 wheels, foot-activated brake, wrist strap, non removeable cover
	S16	Light weight stroller, unassisted sitting with full head control to 50 lbs.	Reclining seat, not compatible with car seats, 4 wheels



**Table 7.** Marketed use and other notes for rockers, swings, and infant floor seats.

Category	Sample	Marketed Use	Other Notes/Descriptive Text
Rocker	S17	Rocking chair, soothing, playtime for infant to toddler	Reclining seat, two positions (upright and recline), fold out kickstand for stationary mode or flip back for rocking mode, machine washable, toy attachment
	S18	Rocker, swing, bouncer, maximum weight of 25 lbs	5 unique motions, adjustable recline, machine washable, toy attachment
	S19	Rocker, lounging, socializing, maximum weight of 25 pounds, 0-3 months with head hugger insert	4 heights, 3 reclining angles, max. height is very tall compared to other products, machine washable, toy attachment
	S20	Rocker, bouncer, 0-6 months or 5-20 lbs	Soft vibrations, machine washable, toy attachment
Swings	S21	Swing (side-to-side or head-to-toe), 0-6 months	Machine washable, 6 swing speeds, adjustable seat recline, toy attachment
	S22	Swing, rocker, bouncer, less than 24 months	Removable seat can be used as a rocker, 3 swinging directions, 6 seppeds, 2-speed vibration, toy attachment
	S23	Swing, sway, rock-a-bye, 0-9 months/6-20 lbs	2 recline positions, toy attachment
	S24	Swing, rocker, bouncer, 6-25 lbs. 0-4 months	6 motions, machine washable, 2 recline postions, toy attachment
Infant Floor Seats	S25	Tummy time, seated support, 0+months/newborn to older babies	Stacks in C shape with security belt and unstacked to support tummy time, plush, toy attachment
	S26	Seat, 4-12 months	2 position floor seat, machine washable, toy attachment
	S28	Chair, for infants able to hold their head up unassisted, up to 25 lbs	Rotate between tray or toys, machine washable, toy attachment
	S29	Sitting chair, 3-12 months	Machine washable, plush

Warning labels for infant carriers (**Figure 10**), bouncers (**Figure 11**), strollers (**Figure 12**), rockers (**Figure 13**), swings (**Figure 14**), and infant floor seats (**Figure 15**) are presented below. Most products included Spanish warnings in addition to English warnings, but this was not a focus of our analysis.

Most of the warnings for the infant carriers (**Figure 10**) are related to use inside of the vehicle (as an infant carrier function), though one warning on all four infant carriers warns that “Children have STRANGLED in loose or partially buckled harness straps. Fully restrain the child even when the carrier is used outside the vehicle.” All products used pictograms to explain the main warnings. There was no warning related to sleeping in the infant carriers. Overall, warnings were consistent for infant carriers.





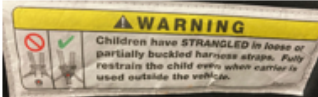

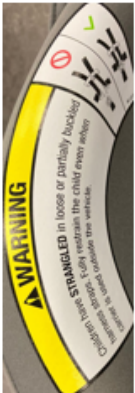


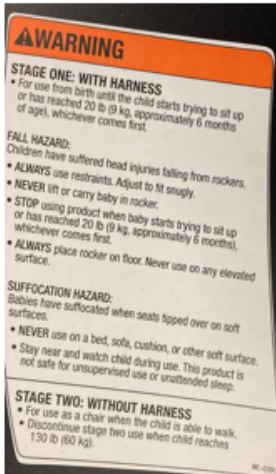


S05	S06	S07	S08
	 	 	 

Figure 10. Warning labels from infant carrier products.

Bouncer products (**Figure 11**) all featured warnings related to fall hazards, using the product only on the floor, always using snugly fitting restraints, and not lifting or carrying the bouncer while the infant is lying in it. All bouncers also include the phrase “ALWAYS use restraints and adjust to fit snugly, even if baby falls asleep” which does not expressly warn parents against using the product for sleep. Furthermore, two products (S09 and S10) contain warnings related to not leaving a child unattended due to a suffocation hazard when bouncers tip over on soft surfaces, but the other two products (S11 and S12) do not contain that language. Three of the four products (S09, S11, and S12) have warning labels on the front of the product. Two bouncers (S09 and S10) were convertible products, so they contained additional warnings related to the chair function of the products for older children who can walk. One product (S09) contained a pictogram related to attending a child, while the others did not.

S09	S10	S11	S12
 			

**Figure 11.** Warning labels from bouncer products.

Stroller products contained variable warnings (Figure 12). Some products were convertible products (S13 and S14) which facilitated the use of an infant carrier in the stroller, so additional warnings were included for those products. Warnings included fall hazards from tip over, never leaving a child unattended, and warnings specific to tray, bar, basket, or wheel features. Product warnings did not mention sleep.

S13	S14	S15	S16

Figure 12. Warning labels for stroller products.



Warning labels on the rocker products (**Figure 13**) all included language related to falling out of the product and to suffocating when the products tip over on soft surfaces. Other common language included use of snugly fit restraint systems and never using the product on a bed, sofa, cushion, or other soft surface. Two products (S17 and S18) stated: “Stay near and watch child during use. This product is not safe for unsupervised use or unattended sleep.” Product S19 includes instructions on use of the “newborn pillow” insert which is “recommended for use with newborn and small babies for additional head support and leg positioning.” S20 is a bouncer and a rocker, so multiple warning labels existed.





S17	S18	S19	S20
 <p><b>WARNING</b></p> <p><b>FALL HAZARD:</b> Children have suffered head injuries falling from rockers.</p> <ul style="list-style-type: none"> <li>• ALWAYS use restraints until child is able to climb in and out of the product unassisted. Adjust to fit snugly.</li> <li>• NEVER lift or carry child in rocker.</li> <li>• STOP using rocker when child has reached 40 lb (18 kg).</li> <li>• The upright position is only for children who have developed enough upper body control to sit up without tipping forward.</li> <li>• ALWAYS place rocker on floor. Never use on any elevated surface.</li> </ul> <p><b>SUFFOCATION HAZARD:</b> Children have suffocated when seats tipped over on soft surfaces.</p> <ul style="list-style-type: none"> <li>• NEVER use on a bed, sofa, cushion, or other soft surface.</li> <li>• Stay near and watch child during use. This product is not safe for unsupervised use or unattended sleep.</li> <li>• The toy bar is not a carry handle. Never use toy bar to lift or carry product.</li> </ul>	 <p><b>WARNING</b></p> <p><b>FALL and STRANGULATION HAZARDS:</b> Infants have suffered head injuries falling from swings and have strangled in straps.</p> <ul style="list-style-type: none"> <li>• ALWAYS use the restraint system. Adjust to fit snugly.</li> <li>• STOP using product when infant attempts to climb out.</li> <li>• NEVER lift or carry white baby in this product.</li> <li>• The toy bar is not a carry handle. Never use toy bar to lift or carry seat.</li> <li>• ALWAYS place this product on floor. Never use on any elevated surface.</li> </ul> <p><b>SUFFOCATION HAZARD:</b> Infants have suffocated when seats tipped over on soft surfaces.</p> <ul style="list-style-type: none"> <li>• NEVER use on a bed, sofa, cushion, or other soft surface.</li> <li>• Stay near and watch child during use. This product is not safe for unsupervised use or unattended sleep.</li> </ul>	 <p>Newborn pillow is recommended for use with newborn and small babies for additional head support and leg positioning.</p> <p><b>WARNING</b></p> <p><b>SUFFOCATION HAZARD:</b> Discontinue use of newborn pillow when back of baby's head rests up on upper elbow which could block airway.</p> <p><b>FALL HAZARD:</b> Shoulder belts and catch belt must be buckled through slots in newborn pillow.</p> <p>Do not use newborn pillow and recommend you use newborn pillow with your baby's feet and legs positioned in the slots.</p> <p><b>WARNING</b></p> <p><b>SMILE ON GARDEN</b></p>	 <p><b>WARNING</b></p> <p><b>BOUNCER MODE</b></p> <p><b>SUFFOCATION HAZARD:</b> Babies have suffocated over on soft surfaces.</p> <ul style="list-style-type: none"> <li>• NEVER use on a bed, sofa, cushion, or other soft surface.</li> <li>• NEVER leave baby unattended.</li> </ul> <p>To prevent falls and suffocation:</p> <ul style="list-style-type: none"> <li>• ALWAYS use restraints and adjust to fit snugly, even if baby falls asleep.</li> <li>• STOP using bouncer when baby starts trying to sit up or has reached 20 lbs, whichever comes first.</li> </ul> <p><b>WARNING</b></p> <p><b>Fall Hazard:</b> Babies have suffered skull fractures falling while in and from bouncers.</p> <ul style="list-style-type: none"> <li>• Use bouncer <b>ONLY</b> on floor.</li> <li>• ALWAYS use restraints and adjust to fit snugly, even if baby falls asleep.</li> <li>• NEVER lift or carry baby in bouncer.</li> </ul> <p><b>WARNING</b></p> <p><b>ROCKER MODE:</b></p> <p><b>FALL HAZARD:</b> Children have suffered head injuries falling from rockers.</p> <ul style="list-style-type: none"> <li>• ALWAYS use restraints. Adjust to fit snugly.</li> <li>• NEVER lift or carry baby in rocker.</li> <li>• STOP using product when baby starts trying to sit up or has reached 20 lbs, whichever comes first.</li> <li>• ALWAYS place rocker on floor. Never use on any elevated surface.</li> </ul> <p><b>SUFFOCATION HAZARD:</b> Babies have suffocated when seats tipped over on soft surfaces.</p> <ul style="list-style-type: none"> <li>• NEVER use on a bed, sofa, cushion, or other soft surface.</li> <li>• Stay near and watch child during use. This product is not safe for unsupervised use or unattended sleep.</li> </ul>

Figure 13. Warning labels on rocker products.

The warning labels on swings (Figure 14) included fall hazards, use of snugly-fitting restraints, and never leaving a child unattended. Products state “SUFFOCATION HAZARD: Young infants have limited head and neck control. If the seat is too upright, infant’s head can drop forward...” and “compress the airway” (S22, S23, and S24) or “resulting in DEATH” (S21). Product S21 states “This product is not intended to replace a crib or bassinet for prolonged periods of sleep,” while S24 states “This product is not safe for unsupervised use or unattended sleep.” Products with various incline settings have warnings specific to using the product in the most reclined setting for young infants. All four products instruct caregivers to stop using the product when an infant attempts to climb out of swing (approximately 9 months).





S21	S22	S23	S24
 <p><b>WARNING</b> Prevent death: Keep seat fully reclined until child is at least 4 months old AND can hold head up without help. Young infants have limited head and neck control. If seat is too upright, infant's head can drop forward and compress the airway, resulting in DEATH. Prevent serious injury or death from falls or strangling in the restraint system: • Never leave child unattended. • Always use the restraint system. • This product is not intended to replace a crib or bassinet for prolonged periods of sleep. • Discontinue use of product when infant attempts to climb out (approximately 9 months).</p>	 <p><b>WARNING</b> Prevent serious injury or death. <b>FALL HAZARD:</b> Children have suffered head injuries falling from product. • ALWAYS use restraints. Adjust to fit snugly. • NEVER use this product to carry or transport a child. • NEVER use restraints on side product. • Use only on floor. Never place product near edges of counter tops, tables, or other elevated surfaces. • STOP using product when baby starts trying to sit up or has reached 18 lb (8.2 kg), whichever comes first. • NEVER use this product as a means to transport an infant in a motor vehicle. <b>SUFFOCATION HAZARD:</b> Babies have suffocated when seats tipped over on soft surfaces. • NEVER use on a bed, sofa, cushion, or other soft surface. • Stay near and watch child during use. This product is not safe for unsupervised use or unattended sleep. <b>WARNING</b> <b>SUFFOCATION HAZARDS:</b> Young infants have limited head and neck control. If the seat is too upright, infant's head can drop forward and compress the airway. • ALWAYS keep swing seat fully reclined until infant is at least 4 months old AND can hold up head without help.</p>	 <p><b>WARNING</b> <b>FALL and STRANGULATION HAZARDS:</b> Infants have suffered head injuries falling from swings and have strangled in straps. • NEVER leave the child unattended. • ALWAYS use the restraint system. Adjust to fit snugly. • STOP using product when baby can sit upright unassisted, attempts to climb out of swing (approximately 9 months), or has reached 20 lb (9 kg), whichever comes first. • Stay near and watch child during use. This product is not safe for unsupervised use or unattended sleep. This product is not intended for prolonged periods of sleeping. • ALWAYS place product on floor. NEVER use this product on an elevated surface (eg. a table). • DO NOT move or lift this product with the baby inside it. Never lift product using a toy bar as a handle. • NEVER attach any additional straps or straps to product. <b>SUFFOCATION HAZARD:</b> Young infants have limited head and neck control. If the seat is too upright, infant's head can drop forward and compress the airway. • ALWAYS keep swing seat fully reclined until infant is at least 4 months old AND can hold up head without help. <b>SUFFOCATION HAZARDS:</b> Babies have suffocated when seats tipped over on soft surfaces. • NEVER use on a bed, sofa, cushion, or other soft surface.</p>	 <p><b>WARNING</b> <b>FALL and STRANGULATION HAZARDS:</b> Infants have suffered head injuries falling from swings and have strangled in straps. • ALWAYS use restraints. Adjust to fit snugly. • STOP using product when infant attempts to climb out (approximately 9 months) sits near and watch infant during use. This product is not safe for unsupervised use or unattended sleep. • SUFFOCATION HAZARD: Young infants have limited head and neck control. If the seat is too upright, infant's head can drop forward and compress the airway. • ALWAYS keep swing seat fully reclined until infant is at least 4 months old AND can hold up head without help.</p>

Figure 14. Warning labels on swing products.

Warning labels on infant floor seat products also varied greatly (Figure 15). Two products only had tags (S25 and S29) with no labels sewn onto the product surface. Of all the products, S29 appears to have the most unconventional warnings, without the typical font or pictogram of the exclamation sign inside the triangle and with non-standardized language. Most products stated that the product should only be used with “a child that is able to hold their head up unassisted,” and that infants should be kept in view during use. Two products (S26 and S28) mention not to use the product in or near water. All products state that the infant floor seat should be used only on the floor. Two products (S25 and S29) specifically warn against infants sleeping in the product.



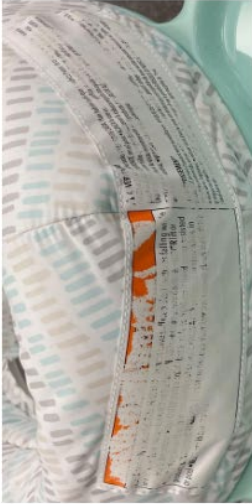

S25	S26	S28	S29
 <p><b>WARNING</b>  <b>SUFFOCATION HAZARD:</b>      • NEVER place this product in a crib or playpen, or allow an infant to sleep on this product.      • Strings can cause strangulation. Never attach additional strings, cords, or straps.  <b>FALL HAZARD:</b>      • NEVER use this product on any elevated surface such as a sofa, table, countertop or chair.      • NEVER lift or carry baby in product.      • For beginning sitters, stay within arm's reach of your child at all times.      • Use only on a level surface.      • Make sure all straps are secure before using as a positioner.      • Adult supervision required.</p> <p><small>Spot clean only with a damp sponge or cloth. Do not machine wash. Do not use bleach. Do not iron. Do not dry clean.      MADE IN CHINA      2545 0721</small></p>	 <p><b>WARNING</b>  <b>FALL HAZARD:</b> Infants have suffered skull fractures falling while in and from floor seats.      • Use ONLY on the floor. • NEVER use on any elevated surface. • ALWAYS use restraints.      Adjust to fit snugly. • NEVER lift or carry baby in product. • Use ONLY with a child that is able to hold their head up unassisted. • STOP using when child can climb out or walk.      • ALWAYS keep child in view during use. • NEVER use in or near water.  <b>DROWNING HAZARD:</b> Infants have drowned when floor seat has been placed in a bath tub or pool. • NEVER use in or near water.</p>		 <p><b>Read before each use.</b>      Do not leave a baby unattended!      Do not allow a baby to sleep in the product!      Do not pick the product up with a baby in it!      Do not leave a baby in the product for extended periods of time!      Baby must be able to support its own head!  <b>Designed for floor use only!</b>      Always use the product under <b>adult</b> supervision.</p>

Figure 15. Warning labels on infant floor seat products. The photo of the warning label on S28 has rubbed off due to the duct tape we placed over the warning label prior to human subjects testing. However, the language was inscribed prior to this photo.

Warning label language is summarized in **Table 8**, **Table 9**, and **Table 10**.

**Table 8.** Warning label language for infant carriers and bouncers.

Category	Sample	Warning Labels
Infant Carriers	S05	Do not place rear-facing child seat on front seat with air bag. Death or serious injury can occur. The back seat is the safest place for children 12 and under. Children have strangled in loose or partially buckled harness straps. Fully restrain the child even when carrier is used outside the vehicle.
	S06	Do not place rear-facing child seat on seat with air bag. Death or serious injury can occur. The back seat is the safest place for children 12 and under. Children have strangled in loose or partially buckled harness straps. Fully restrain the child even when carrier is used outside the vehicle.
	S07	Do not place rear-facing child seat on front seat with air bag. Death or serious injury can occur. The back seat is the safest place for children 12 and under. Children have strangled in loose or partially buckled harness straps. Fully restrain the child even when carrier is used outside the vehicle.
	S08	Do not place rear-facing child seat on front seat with air bag. Death or serious injury can occur. The back seat is the safest place for children 12 and under. Children have strangled in loose or partially buckled harness straps. Fully restrain the child even when the carries is used outside the vehicle.
Bouncers	S09	NEVER leave baby unattended. Do not use the bouncer once your child can sit unaided. Child's activity may move product. Suffocation Hazard: Babies have suffocated when bouncers tipped over on soft surfaces. Never leave baby unattended. To prevent falls and suffocation: ALWAYS use restraints and adjust to fit snugly, even if baby falls asleep. STOP using bouncer when baby starts trying to sit up or has reached 9kg/20lbs, whichever comes first. CHAIR (max. 29lbs/13kg): Use as chair when your child can walk and sit on her own. Do not use restraint system. AMPUTATION HAZARD: Chair can fold or collapse if lock is not fully engaged. Moving parts can amputate child's fingers. Keep fingers away from moving parts. Completely unfold chair and fully engage locks before allowing child to sit in chair. Never allow child to fold or unfold chair. Fall Hazard: Babies have suffered skull fractures falling while in and from bouncers. Use bouncers ONLY on floor. ALWAYS use restraints and adjust to fit snugly, even if baby falls asleep. NEVER lift or carry baby in bouncer.
	S10	STAGE ONE: WITH HARNESS. For use from birth until the child starts trying to sit up or has reached 20 lb (9 kg, approximately 6 months of age), whichever comes first. FALL HAZARD: Children have suffered head injuries falling from rockers. ALWAYS use restraints. Adjust to fit snugly. NEVER lift or carry baby in rocker. STOP using product when baby starts trying to sit up or has reached 20 lb (9 kg, approximately 6 months), whichever comes first. ALWAYS place rocker on floor. Never use on any elevated surface. SUFFOCATION HAZARD: Babies have suffocated when seats tipped over on soft surfaces. NEVER use on a bed, sofa, cushion, or other soft surface. Stay near and watch child during use. This product is not safe for unsupervised use or unattended sleep. STAGE TWO: WITHOUT HARNESS. For use as a chair when the child is able to walk. Discontinue stage two use when child reaches 130 lb (60 kg).
	S11	FALL HAZARD: Babies have suffered skull fractures falling while in and from bouncers when not used properly. Use bouncer ONLY on the floor. ALWAYS use restraints and adjust to fit snugly, even if baby falls asleep. NEVER lift or carry baby in bouncer.
	S12	FALL HAZARD: Babies have suffered skull fractures falling while in and from bouncers when not used properly. Use bouncer ONLY on the floor. ALWAYS use restraints and adjust to fit snugly, even if baby falls asleep. NEVER lift or carry baby in bouncer. NEVER use toy bar as a handle.



Table 9. Warning label language for strollers and rockers.

Category	Sample	Warning Labels
Strollers	S13	Avoid serious injury or death: Never leave child unattended. To avoid serious injury from falling or sliding out, always use seat belt. Remove child when adjusting the seat from or to bassinet.
	S14	Do not place rear-facing child seat on seat with air bag. Death or serious injury can occur. The back seat is the safest place for children 12 and under. Children have strangled in loose or partially buckled harness straps. Fully restrain the child even when carrier is used outside the vehicle.
	S15	Before using the S12 Stroller, consult the user guide for additional safety warnings and instructions. Never leave child unattended. Always use wrist strap. Stroller is equipped with three quick release wheels. To avoid serious injury, consult user guide for removal and installation instructions. Do not hang or place items on the stroller handlebar or frame except for those approved by S12 gear. They may cause an unstable or hazardous condition to exist. Always ensure parking brake is fully engaged when stroller is not moving. FALL HAZARD from tip over. Before running, jogging, or walking fast, LOCK the front wheel from swiveling. When seat is fully reclined, backward tip-over is more likely, and may result in injury to stroller occupant. Always jog with the stroller seat in the fully upright position.
	S16	See instructions for additional warnings. If you are without an instruction sheet, DO NOT use this product. IN USA & Canada call ..... Never leave child unattended. Make sure children are clear of any moving parts if you adjust the stroller, otherwise they may be injured. Take Care when folding and unfolding to prevent finger pinching. DO NOT lift by tray/bar or toy. Product may become unstable if a storage bag, other than the one recommended by the manufacturer is used. To prevent stroller from becoming unstable or tipping do not put more than 10 lbs total (4.54 kg) in the baskets. To avoid injury to your child, DO NOT use basket as a child carrier!
Rocker	S17	FALL HAZARD: Children have suffered head injuries falling from rockers. ALWAYS use restraints until child is able to climb in and out of the product unassisted. Adjust to fit snugly. NEVER lift or carry child in rocker. STOP using rocker when child has reached 40 lb (18kg). The upright position is only for children who have developed enough upper body control to sit up without tipping forward. ALWAYS place rocker on floor. Never use on any elevated surface. SUFFOCATION HAZARD: Children have suffocated when seats tipped over on soft surfaces. Never use on a bed, sofa, cushion, or other soft surface. Stay near and watch child during use. This product is not safe for unsupervised use or unattended sleep. The toy bar is not a carry handle. Never use toy bar to lift or carry product.
	S18	FALL and STRANGULATION HAZARD: Infants have suffered head injuries falling from swings and have strangled in straps. ALWAYS use the restraint system. Adjust to fit snugly. STOP using product when infant attempts to climb out. NEVER lift or carry while baby is in this product. The toy bar is not a carry handle. Never use toy bar to lift or carry seat. ALWAYS place this product on floor. Never use on any elevated surface. SUFFOCATION HAZARD: Infants have suffocated when seats tipped over on soft surfaces. NEVER use on a bed, sofa, cushion, or other soft surface. Stay near and watch child during use. This product is not safe for unsupervised use or unattended sleep.
	S19	Newborn pillow is recommended for use with newborn and small babies for additional head support and leg positioning. SUFFOCATION HAZARD: Discontinue use of newborn pillow when back of baby's head rests up on upper pillow section. FALL HAZARD: Shoulder belts and crotch belt must be routed through slots in newborn pillow.
	S20	BOUNCER MODE SUFFOCATION HAZARD: Babies have suffocated when bouncers tipped over on soft surfaces. NEVER use on a bed, sofa, cushion, or other soft surface. NEVER leave baby unattended. To prevent falls and suffocation: ALWAYS use restraints and adjust to fit snugly, even if baby falls asleep. STOP using bouncer when baby starts trying to sit up or has reached 20 lbs, whichever comes first. Fall Hazard: Babies have suffered skull fractures falling while in and from bouncers. Use bouncer ONLY on floor. ALWAYS use restraints and adjust to fit snugly, even if baby falls asleep. NEVER lift or carry baby in bouncer.

Table 10. Warning label language for swings and infant floor seats.

Category	Sample	Warning Labels
Swings	S21	Prevent death: Keep seat fully reclined until child is at least 4 months old AND can hold head up without help. Young infants have limited head and neck control. If seat is too upright, infant's head can drop forward and compress the airway, resulting in DEATH. Prevent serious injury or death from falls or strangling in the restraint system: Never leave child unattended. Always use the restraint system. This product is not intended to replace a crib or bassinet for prolonged periods of sleep. Discontinue use of product when infant attempts to climb out (Approximately 9 months).
	S22	SWING: FALL and STRANGULATION HAZARDS: Infants have suffered head injuries falling from swings and have strangled in straps. ALWAYS use restraints. Adjust to fit snugly. STOP using product when infant attempts to climb out (approximately 9 months). Stay near and watch infant during use. This product is not safe for unsupervised use or unattended sleep. Remove child from swing before changing batteries. If you are without an instruction sheet, DO NOT use this product. Call XXX-XXX-XXXX
	S23	FALL and STRANGULATION HAZARD: Infants have suffered head injuries falling from swings and have strangled in straps. NEVER Leave the child unattended. ALWAYS use the restraint system. Adjust to fit snugly. STOP using product when baby can sit upright unassisted, attempts to climb out of swing (approximately 9 months), or has reached 20 lbs (9kg), whichever comes first. Stay near and watch child during use. This product is not safe for unsupervised use or unattended sleep. This product is not intended for prolonged periods of sleep. ALWAYS place product on floor. NEVER use this product on an elevated surface (e.g. a table). DO NOT move or lift this product with the baby inside it. Never lift product using a toy bar as a handle. NEVER attached any additional strings or straps to product. SUFFOCATION HAZARD: Young infants have limited head and neck control. If the seat is too upright, infant's head can drop forward and compress airway. ALWAYS keep swing seat fully reclined until infant is at least 4 months old AND can hold up head without help. SUFFOCATION HAZARD: Babies have suffocated when seats tipped over on soft surfaces. NEVER use on a bed, sofa, cushion, or other soft
	S24	FALL and STRANGULATION HAZARDS: Infants have suffered head injuries falling from swings and have strangled in straps. ALWAYS use restraints. Adjust to fit snugly. STOP using product when infant attempts to climb out (approximately 9 months). Stay near and watch infant during use. This product is not safe for unsupervised use or unattended sleep. SUFFOCATION HAZARD: Young infants have limited head and neck control. If the seat is too upright, infant's head can drop forward and compress the airway. ALWAYS keep swing seat fully reclined until infant is at least 4 months old AND can hold up
Infant Floor Seats	S25	SUFFOCATION HAZARD: NEVER place this product in a crib or playpen, or allow an infant to sleep on this product. Strings can cause strangulation. Never attach additional strings, cords, or straps. FALL HAZARD: NEVER use this product on any elevated surface such as a sofa, table, countertop or chair. NEVER lift or carry baby in product. For beginning sitters, stay within arm's reach of your child at all times. Use only on a level surface. Make sure all straps are secure before using as a positioner. Adult supervision
	S26	FALL HAZARD: Infants have suffered skull fractures falling while in and from floor seats: Use ONLY on the floor. NEVER use on an elevated surface. ALWAYS use restraints. Adjust to fit snugly. NEVER lift or carry child in the product. Use ONLY with a child that is able to hold their head up unassisted. STOP using when child can climb out or walk. ALWAYS keep child in view while in product. DROWNING HAZARD: Infants have drowned when floor seat has been placed in a bath tub or pool. NEVER use in or
	S28	NEVER leave child unattended. FALL HAZARD: Infants have suffered skull fractures falling while in and from floor seats. Use ONLY on the floor. NEVER use on an elevated surface. NEVER lift or carry child in the product. Use ONLY with a child that is able to hold their head up unassisted. STOP using when the child can climb out or walk. ALWAYS keep child in view while in product. DROWNING HAZARD: Infants have drowned when floor seat has been placed in a bath tub or pool. NEVER use in or near water.
	S29	Read before each use. Do not leave a baby unattended! Do not allow a baby to sleep in the product! Do not pick the product up with a baby in it! Do not leave a baby in the product for extended periods of time! Baby must be able to support its own head! Designed for floor use only! Always use the product under adult supervision.

### 3.4 Product Characterization Discussion

The infant seated products vary greatly, sometimes even within the product categories. In general, the products feature an inclined back with a seat design and a harness (waist harness or 5-point harness with a chest clip). Common phrases on warning labels related to the harness fit in many types of products note that the harness should have a snug fit, which is an ambiguous and undefined term. It is unclear how snug is “snug enough”, and if there are any negative implications if the harness is fit too tightly. We are unaware if any testing has been conducted to understand how the various tensions in the harness straps influence safety in these seated products. Most warnings are easily seen and are strategically placed so that you would see them while looking at your infant in the product. Most are highlighted with bright yellow, orange, or red colors. However, some lack a bright color to highlight them as important and some are in odd locations, such as S14 where the label is in the support surface underneath the infant.

The base of the products was one distinct difference between product categories. After we took measurements, we calculated the ratio of the seat width to the base width, with the idea that a product with a seat that is wider than the base (or a ratio >1) would pose a greater hazard for tipping compared to a product with a seat that is narrower than the base (or a ratio of <1). **Table 11** shows our calculations, where the lower the ratio, the less concern for a tip-over hazard.

**Table 11.** Table of seat width and base width values, and a ratio, where a ratio of >1 means the seat is wider than the base, and a ratio of <1 means the base is wider than the seat.

Category	Sample	Seat Width (cm)	Base Width (cm)	Ratio - Seat to Base
Infant Carriers	S05	37.5	26.9	1.4
	S06	38.8	27.2	1.4
	S07	37.9	31.4	1.2
	S08	38.0	25.4	1.5
Bouncers	S09	35.0	38.9	0.9
	S10	53.1	67.9	0.8
	S11	43.5	45.6	1.0
	S12	58.3	54.9	1.1
Strollers	S13	40.3	56.4	0.7
	S14	38.1	59.8	0.6
	S15	40.0	57.2	0.7
	S16	34.4	42.4	0.8
Rocker	S17	45.2	52.4	0.9
	S18	42.4	47.5	0.9
	S19	41.3	63.5	0.7
	S20	39.3	39.0	1.0
Swings	S21	51.0	109.5	0.5
	S22	51.8	80.5	0.6
	S23	42.9	49.4	0.9
	S24	42.4	49.1	0.9
Infant Floor Seats	S25	37.4	36.4	1.0
	S26	33.2	43.1	0.8
	S28	37.6	49.9	0.8
	S29	54.2	41.4	1.3

A common theme emerges for the infant carriers which feature narrow bases and wider seats, meaning their base of support is small compared to the seat. This can help explain the numerous tip-over incidents in infant carriers that we reviewed as part of the IDIs. Infants can more easily shift the center-of-gravity of the infant-product set outside of the base of support, resulting in a tip-over situation.

Infant carriers feature the most rigid frame of all seated product categories and had the most consistency in the warning labels. All infant carriers feature a five-point harness with a chest clip. All designs are made with an entirely solid plastic frame covered with soft goods typically made of foam. The homogeneity of the infant carrier product category makes sense, considering these products also function as infant carriers and are heavily regulated by the National Highway Traffic Safety Administration with strict standards to ensure safety in a motor vehicle crash situation. However, the products in our study are considered for use outside of the car setting as infant carriers, seats, and as attachments into stroller frames. Infant carriers also feature body inserts and pillow-like head rests made of foam. There is no language on any infant carrier warning label related to infants sleeping within the device, inside or outside of the motor vehicle setting.

Bouncers and swings commonly contain plush soft goods such as body inserts and pillows, ranging from 1.6 cm to 7.8 cm thick and primarily filled with polyester fiber batting and polyurethane materials. We also note that many of the pillows, in particular, are not firmly fixed to the surface of the product, and instead are fixed only by a short tether meaning they could easily flop around the location of where the infant's head is lying (see section 4). Warning labels on some of the swings note that if infants are "too upright" in the products, that their heads can flop forward and compress their airways. Swings also contain warnings that infants should not use the products for "prolonged periods of sleep." However, both of these phrases – "too upright" and "prolonged periods of sleep" – are ambiguous without any quantitative instruction on what these terms mean to a caregiver. Furthermore, researchers and clinicians do not differentiate between overnight sleep and daytime napping for infants – and especially for newborns. While adult sleep patterns can be differentiated between napping and overnight sleep, numerous researchers have concluded that for infants, this distinction is not clear since infants, especially preterm infants, spend so much more time in REM sleep compared to older children and adults (Haddad et al., 1981; Katz et al., 2012; Parmelee et al., 1967; Whitehead et al. 2018; Montemitro et al., 2008), which means an infant's arousal response is less effective during both naps

and overnight sleep as they are more often in a deep sleep state and cycling between sleep states. If a product is not safe for overnight sleep for infants, it is not safe for daytime napping either.

Many seated products feature convertible designs, meaning that they can be used as more than one product category. Some products are also considered infant-to-toddler products, meaning there are different settings intended for younger and older children. For example, one product (S20) can be classified as a bouncer or a rocker, depending on the setting. Other products (e.g., S10 and S17) can be used for infants in a more reclined setting, and for older children as a more upright seat. In fact, product S10 can be used in the upright setting for children up to 130 lbs. Finally, one of the infant carriers in our study (S06) could attach to a stroller (S14) for use as a travel system outside of a motor vehicle. The hazard warnings on these more complex products are generally much longer than products with a simpler design. Furthermore, some of the warnings are contradictory for the infant-setting compared to the older-child setting. For example, product S10 warns parents to always use the restraint in the younger child setting, then states to remove the harness for use in the older child setting. This may be confusing to consumers. Additionally, significant hazards will be presented to infants if they are placed in a product in the older setting configuration. In fact, we saw this exact concern in the IDIs we reviewed, particularly with product S17.

Several seated products contained explicit warnings related to using the product only on the floor. Yet, based on the IDI reviews from section 2, it is clear that this instruction is not always followed. In some IDIs, infants did tip the products when they were restrained and unrestrained, resulting in hazardous situations which were fatal in some cases. Thus, manufacturers could consider a more robust tip over test for products that parents sometimes put on softer surfaces like beds or couches, for example, infant carriers, bouncers, and infant floor seats which each have smaller footprints and could feasibly fit on a bed. Our calculation related to the base of support ratio show that the infant carriers in particular are more likely to tip than other products with a larger base of support. A tip-over requirement whose test is conducted on a less firm surface may prevent some of the fatalities related to tipping on a softer surface.

The back and thigh angles that we measured using the infant-sized hinged weight gauge are similar to the back and thigh angles of the inclined sleeper products that we previously researched (Mannen et al., 2019; Wang et al., 2021). The range of back incline angles of the seated products in this study was 22° to 45°, while the range of back incline angles in the inclined sleeper study was 9° to 31°.

Our previous research showed that the higher the incline angle, the more biomechanical impacts are subjected to the infants. At an angle of 30°, infants slide down an inclined surface (Wang et al., 2020). Many of the seated products in this study feature substantially similar designs to the now-banned inclined sleep products, while other seated products feature more upright designs. Much if not all of the research we conducted as part of our previous inclined sleeper study can be applied to many of the products in this current study on infant seated products.

We also noted unique language in some marketing materials related to the description of the product. For example, terms like “comfortable” (S08); “breathable,” “safe,” and “healthier choice” (S10); “extra-cushy seat” and “soft head support” (S12); “ergonomic seat” and “just like lying in mother’s arms” (S24); and “safely wraps your baby in plush comfort” (S29). Many of these terms are undefined in terms of the safety of infant products and may confuse parents since they have ambiguous meanings.

Finally, the products we reviewed were all brand new and assembled by our research team. Like most materials, some degradation of materials can be expected over time. We did not investigate as part of this study how storage or use may influence the characterization of the seated products.

### 3.5 Product Characterization Conclusions

We recommend that if products are not intended for sleep, that hazard warnings include explicit language making clear that any duration of sleep is not safe. Hazard warnings should be consistent across product categories – while this was the case for most products, a few products did not follow this pattern. Ambiguous words should be avoided in the marketing of seated products.

The ratio of the width of the seat to the base of support should be more fully investigated as a design criterion for seated products to prevent tipping. Tip-over testing should be considered on softer surfaces.

Convertible products (meaning those that span more than one product category) and products with different settings for various aged children can be confusing to consumers. We noted some IDs which explicitly state that the product was used with an infant in a setting intended for older children, indicating that this is a hazardous feature for infants if parents unknowingly use the wrong setting. Furthermore, the environmental impacts of storage and use should be considered in the future.

There are obvious benefits of convertible seated products and products which can be used for several years for consumers. Economically, it can be less expensive to purchase a single product that can serve more than one purpose or can be used throughout many years of a child's life. It is also beneficial from an environmental perspective to design products that are not defunct after only a few months. Furthermore, for people with limited space, these unique products are attractive options. Considering both the hazards and the benefits of convertible products and those with settings for various ages, we recommend that manufacturers work to design products that reduce the risk of misuse for infants. We do not know what this solution might be, but we encourage more discussion and creative thinking related to this topic considering that the industry continues to innovate convertible products.



## 4. Head Rotation Testing

### 4.1 Head Rotation Overview

Many IDIs we reviewed indicated that an infant's face was in direct contact with soft goods of the seated product. Proximity of an infant's face to a soft and semi-permeable or non-permeable surface can introduce three different hazards all related to suffocation: (1) occlusion of the mouth/nose due to contact with the surface, limiting airflow by direct occlusion of the breathing orifices; (2) increasing the resistance of airflow during inhalation, making the work of breathing more difficult on the infant; and (3) contributing to an abnormal exchange of gases, meaning decreased O<sub>2</sub> and/or increased CO<sub>2</sub> if the normal exchange of gases during respiration is influenced by product proximity to the mouth/nose.

Occlusion can occur if an infant's face is in contact with a surface which completely envelops their nose and mouth, mechanically restricting all airflow. An example of this is a newborn with no head-neck control lying prone on a surface which mechanically closes their nares and mouth, preventing all exchange of air and causing suffocation via hypoxia, meaning a person does not have enough O<sub>2</sub>.

Resistance of airflow can occur in a similar way to the previous example, except imagining that an infant is contacting a surface that is semi-permeable, so some exchange of air is possible. However, because of the material resisting some airflow, an infant must work harder to inhale the same amount of air compared to free breathing. This means that the work of breathing is increased, and if an infant cannot self-correct to a safer position, the infant is at a high risk for fatigue and suffocation via hypoxia as they cannot inhale enough oxygen due to the resistance (Côté, 2000; Paluszynska et al., 2004). Airflow resistance can span a range from low resistance to very high resistance where maximal resistance is the same as nasal occlusion – preventing all airflow.

An abnormal exchange of gases can occur in conjunction with the resistance of airflow scenario described above, but it can also occur without a high resistance to airflow. In this scenario, an infant is able to inhale and exhale, but the gases upon exhalation (consisting of a high percentage of CO<sub>2</sub>) do not properly dissipate into the atmosphere and are instead stored in the soft goods, displacing some O<sub>2</sub>. The infant continues to breathe through the material which results in an abnormal exchange of gases since the CO<sub>2</sub> does not properly dissipate into the atmosphere. Some materials and product designs are more conducive to collecting CO<sub>2</sub> (Maltese and Leshner, 2019). This scenario can cause suffocation via a

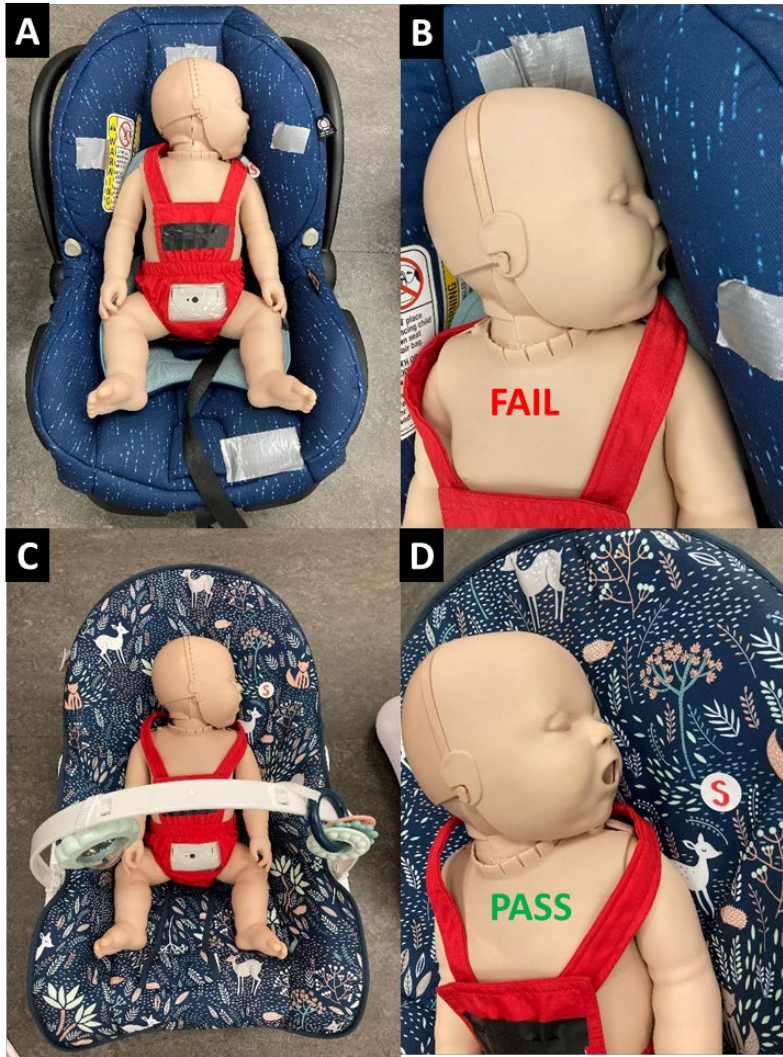


combination of hypoxia and hypercapnia, meaning a person has too little O<sub>2</sub> and/or too much CO<sub>2</sub> in their blood.

We note the challenges with grouping these three separate hazards into a single suffocation category. An autopsy of an infant cannot reveal which single or combination of these scenarios – nasal occlusion, airflow resistance, or an abnormal exchange of gases – was the cause of the death. However, each of these hazards depend on contact and/or close proximity of the mouth/nose with a surface. As part of our Pillow Product Characterization and Testing study (Mannen et al., 2022), we demonstrated that a proximity of <2 cm between an infant’s face and a crib bumper surface increased CO<sub>2</sub> inhalation, and that face contact, both with and without a 10 N load, also increased CO<sub>2</sub> inhalation. Each of these risks can also work together, meaning more than one can increase suffocation risk in the same scenario. All three of these suffocation-related risks (nasal occlusion, airflow resistance, and abnormal exchange of gases) rely on the proximity and interaction of the infant mouth/nose to the product, so understanding how a normal rotation of the infant head results in product interactions in seated products is important. The purpose of this section is to understand how or if a normal head rotation of 90° during intended placement within a seated product results in mouth/nose contact with the side of the seated products.

## 4.2 Head Rotation Methods

We used an anthropometry-based infant (Prestan Professional Infant Manikin Mayfield Village, OH) with a head which rotates in the axial plane. We machined custom rotation plates which allow for 240° of rotation (Mannen et al., 2022), based on previously published range-of-motion studies in infants 2 to 10 months of age that indicate approximately 220° of rotation is possible (Ohman and Beckung, 2008). We placed the infant manikin at the intended position and a slouched position on each product and rotated the device's head to 90° from an anatomically neutral position. The test results were recorded as a pass or fail. If any part of the mouth or nose of the infant manikin was in contact with the side of product it was considered a failure. However, if the infant manikin was not in contact with the side of the product it was considered a pass (**Figure 16**).



**Figure 16.** Example of an (A) and (B) and failed test and (C) and (D) a passed test.

### 4.3 Head Rotation Results

The pass/fail results of the head rotation testing are presented below (Table 12).

**Table 12.** Results of head rotation testing on all 24 products.

Category	Sample Number	Pass/Fail	
		Intended	Slouched
Infant Carrier	S05	Pass	Pass
	S06	Fail	Pass
	S07	Fail	Pass
	S08	Fail	Fail
Bouncers	S09	Pass	Pass
	S10	Fail	Pass
	S11	Pass	Pass
	S12	Fail	Fail
Strollers	S13	Pass	Pass
	S14	Fail	Pass
	S15	Pass	Pass
	S16	Pass	Pass
Rocker	S17	Pass	Pass
	S18	Pass	Pass
	S19	Pass	Pass
	S20	Fail	Fail
Swings	S21	Fail	Fail
	S22	Pass	Pass
	S23	Pass	Pass
	S24	Pass	Pass
Infant Floor Seat	S25	Pass	Pass
	S26	Pass	Pass
	S28	Pass	Pass
	S29	Pass	Pass

Many products passed these head rotation tests – all infant floor seats, and most strollers, rockers, and swings. Generally, the strollers featured flatter surfaces (see section 5), so the infant’s face would not contact the side of the product at a 90° head rotation. Three infant carriers failed the testing in intended placement, meaning that an infant’s face would contact the side of the product at a 90° head rotation. Two bouncers (S10 and S12) also failed the test at intended placement. These products both featured pillow features. The stroller that failed the test used the same infant seat as infant carrier S06. One swing (S21) failed the head rotation test; like the bouncers, it featured a plush pillow feature (Figure 17).



**Figure 17.** Head rotation failures for (A) and (B) product S10 in the intended position; and (C) and (D) product S21 in the slouched position. Product S10 failed in the intended position, while product S21 failed in both the intended and the slouched position.



#### 4.4 Head Rotation Discussion

Proximity of an infant's face to a soft surface can introduce three different hazards all related to suffocation as previously discussed: (1) occlusion of the mouth/nose; (2) increasing the resistance of airflow during inhalation; and (3) contributing to an abnormal exchange of gases. This simple head rotation test elucidates if a normal 90° head rotation results in mouth/nose contact with the side of a seated product. The infant carrier that passed the head rotation test features a wide flat pillow without extremely plush sides (S05), while the infant carrier that failed the head rotation test feature larger pillows and/or inserts with thicker product sides (S06, S07, and S08). The bouncers that passed have no body insert (S09) and only a small pillow (S11), while the bouncers that failed have larger plush features or plush pillow inserts that surround the infant's intended head position (S10 and S12). S14 was the only stroller that failed the test; it is the same product as infant carrier S06 which also failed. The rocker products that passed have no body inserts (S17 and S18) or feature a plush insert that is located above the location of the mouth/nose (S19). S20 was the only rocker that failed; it features a bulky insert that is near the head. The swings that passed the head rotation test have a large, flat insert (S22) or feature small pillows (S23 and S24). Swing S21 failed; it features a plush and fuzzy head pillow.

Generally, small flat inserts and pillows features which are sewn into the surface of seated products pass this head rotation test, indicating they have a lower chance of interfering with the mouth and nose. Thickness of the pillow or body insert, attachment to the seated product, and location of pillows or inserts in addition to the concavity of the seated product (see section 5) are the main factors that influence a pass or fail for this head rotation test, and thus suffocation-related risk.

It is clear from the IDIs that we reviewed, that some infant's heads were turned to the side during supine lying, with their mouth/nose in contact with the side of the product. Thus, we believe this is an important concept to quantify and develop guidelines to decrease the risk of suffocation related to facial contact with seated products. We note, however, that though the infant carrier products failed this head rotation test most often, we did not see this hazard pattern in the infant carrier IDIs that we reviewed – perhaps because the infant carrier soft goods were firmer than some other products (see section 6). Instead, the incidents in the infant carriers were associated with strangulation and tip-overs. While this head rotation test is interesting and the test methodology is simple, a less subjective test with a well-defined threshold for safety related to the risk that an infant's mouth/nose will contact a plush product may be a better option.

#### 4.5 Head Rotation Conclusions

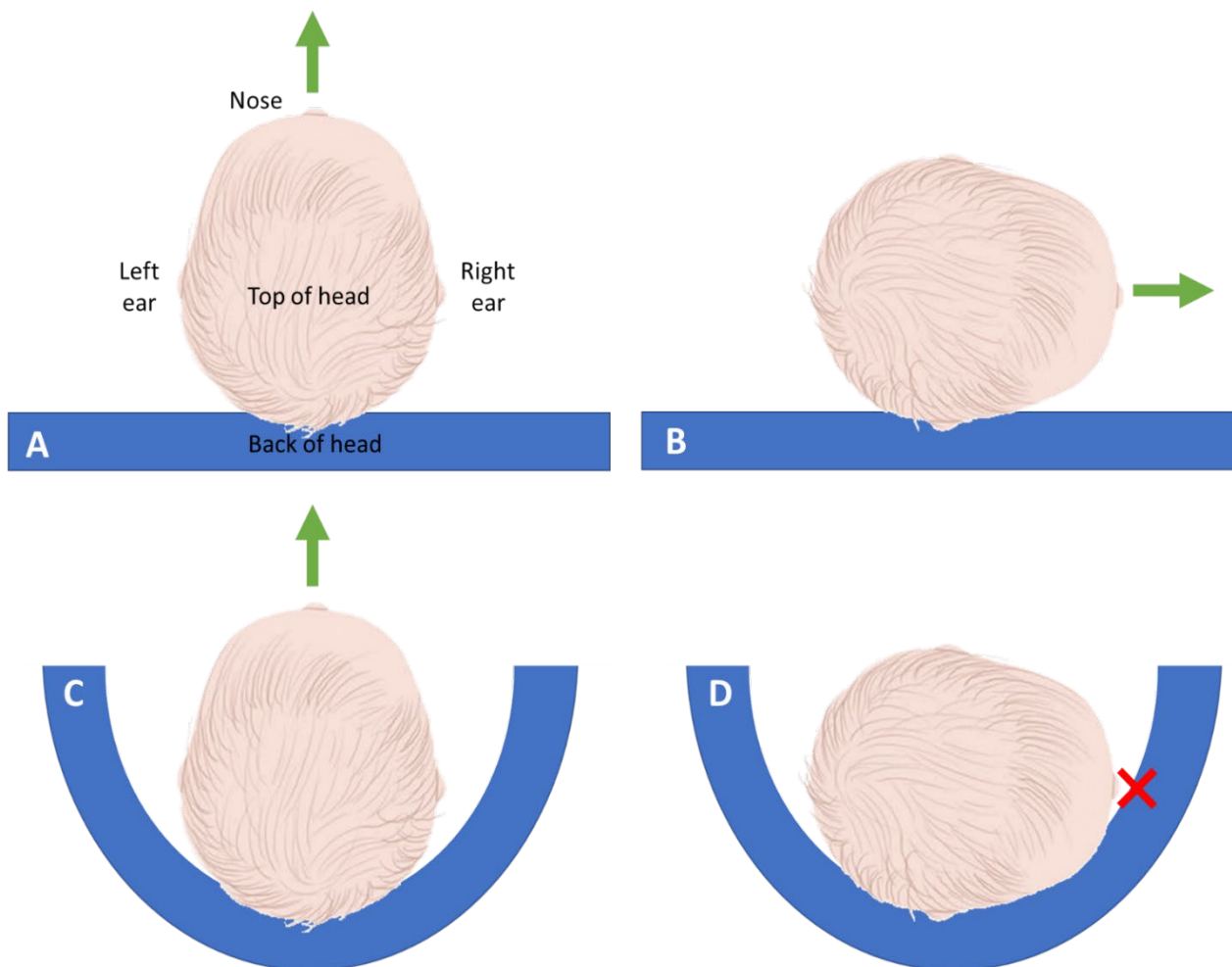
Because we will assess this head rotation data in conjunction with the concavity and conformity data in section 5.5, we have no recommendations related to head rotation testing.

## 5. Concavity and Conformity Testing

### 5.1 Concavity and Conformity Testing Overview

Infant seated products feature unique designs that have varying concave and conforming characteristics. Depending on the type of structural support and the soft goods, the internal shape of a seated product and therefore the nature of the interaction of that product with the infant can be affected by an infant once they are placed in it. The three hazards related to suffocation (occlusion, resistance of airflow, and abnormal exchange of gases) discussed in section 4.1 must also be considered when assessing the concavity and conformity of a product.

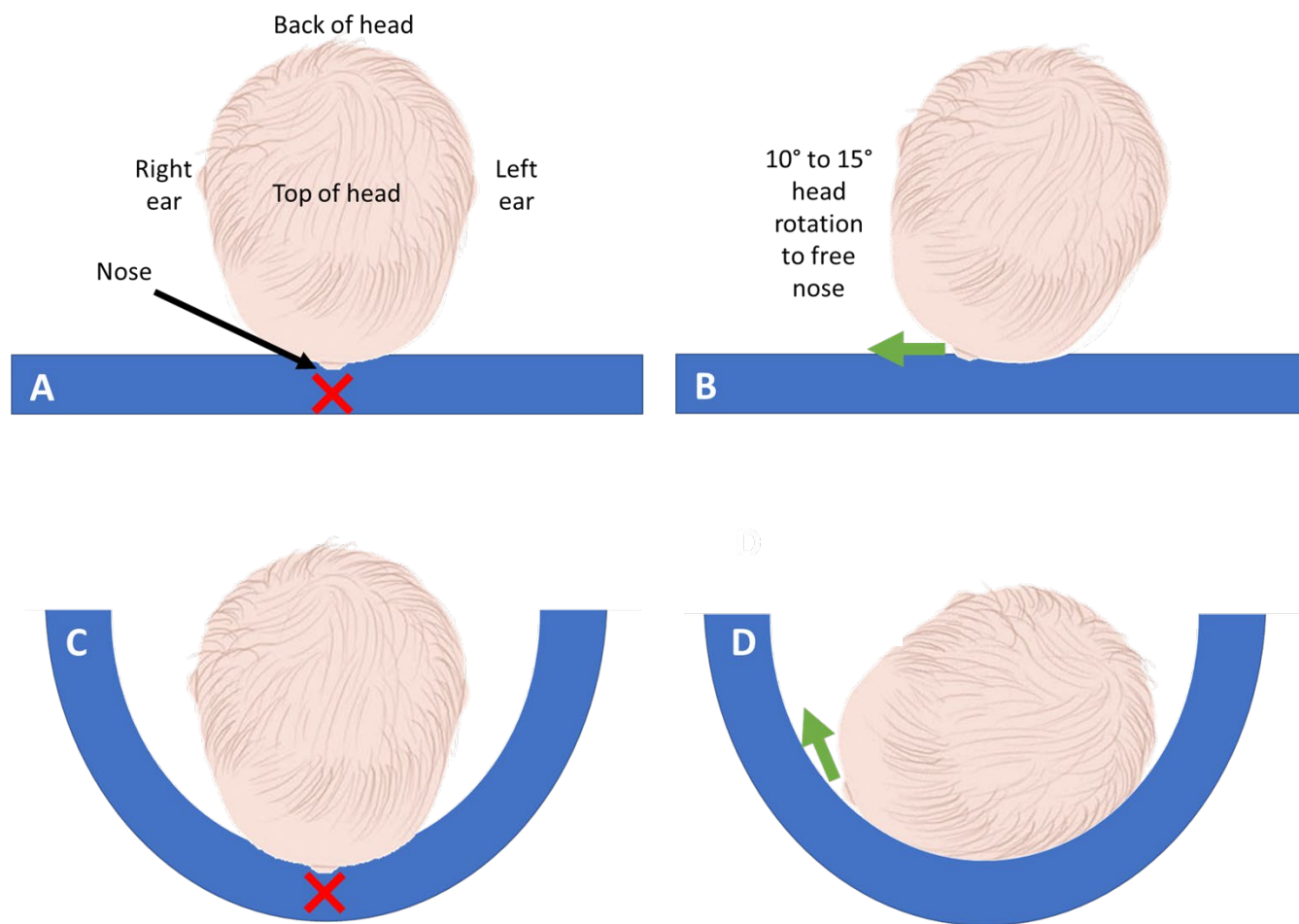
In the intended supine lying position, the design of the product should not result in soft goods near or in contact with the infant's mouth/nose during normal head rotation. As illustrated in **Figure 18**, a concave or a conforming product that results in a concave surface can result in an infant's face in direct contact with the side of the seated product which is unsafe for infants, especially while sleeping.



**Figure 18.** Schematic drawing looking down at the top of the infant’s head, where the green arrows or red x represent the nose and mouth region, depicting an infant lying supine (A) on a crib mattress with no head rotation, (B) on a crib mattress with a 90° head rotation, (C) on a soft and conforming product with no head rotation, and (D) on a soft and conforming product with 90° head rotation depicting the nose and mouth region in direct contact with the plush soft side of the product, creating a serious suffocation hazard.

If an infant were to roll from supine to prone within the product, another hazardous scenario can occur in concave and conforming products. **Figure 19** depicts a prone scenario, showing that only a slight rotation on a flat crib mattress will result in freeing the mouth/nose from a suffocation scenario, whereas a much larger head rotation is required for the same mouth/nose clearance in a concave and conforming product.



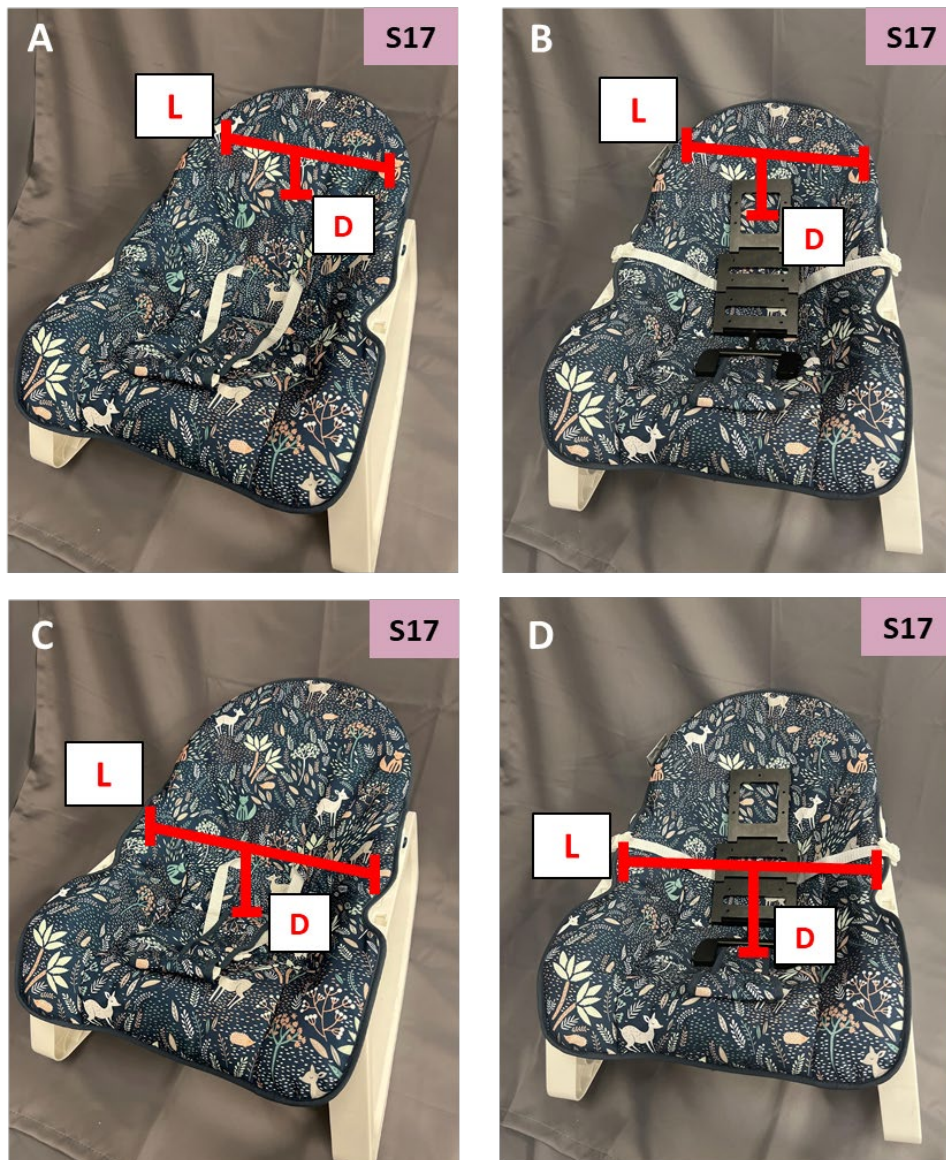


**Figure 19.** Schematic drawing from the top of the head looking down, where the green arrows or red x represent the nose and mouth region, depicting an infant lying prone (A) on a crib mattress with no head rotation, (B) on a crib mattress with a slight head rotation to free their nose to breathe, (C) on a soft and conforming product with no head rotation, and (D) on a soft and conforming product requiring significant head rotation (60° in this example) to free the nose to breathe, creating a serious suffocation hazard especially if an infant does not have head control and neck strength.

The purpose of this section is to develop a simple test method to evaluate concavity and conformity in seated products, then to develop a threshold rooted in infant anthropometric data to reduce the risk for suffocation due to infant mouth/nose interactions with products.

## 5.2 Concavity and Conformity Testing Methods

The purpose of this test was to quantify the concavity and conformity of a range of products in each product category. The concavity and conformity tests were conducted on all 24 products in two locations – at the approximate location where the head of a newborn infant would be lying (head), and at the approximate location where the bottom of a newborn infant would be seated based on the harness seam (seat) (Figure 20).



**Figure 20.** Example measurements on a representative product for the head measurement in the (A) unweighted and (B) weighted conditions; and for the seat measurement in the (C) unweighted and (D) weighted conditions.

We first took the unweighted measurements with nothing in the seated product. First, the width from the right side to the left side of the product was measured with a tape measure, L. This distance was measured directly above the harness and at the intended head position or at the seat bight line. Then the depth was measured with a tape measure, D. This was the distance from the midline of L to the surface of the product for the two locations (head and seat). Then, we considered the weighted condition with the newborn five-segment sagittal plane device placed in each seated product to represent the weight of an infant lying in the product, and the previous steps were repeated to find the distances of L and D at the head and the seat. The radius or concavity of the seated product was calculated through **Equation 1** which is an equation to calculate the radius of a best-fit circle from a chord (L) and a sagitta which is the height of an arc (D) for the unweighted and weighted scenarios, representative of an infant. The change in radius between the unweighted and weighted scenarios for each product was calculated as well, as shown in **Equation 2**. **Figure 21** illustrates the concept.

**Equation 1.** Concavity equation, where the larger the radius (r), the flatter the product.

$$r = \frac{D}{2} + \frac{L^2}{8D}$$

**Equation 2.** Conformity equation, where the larger the change in radius ( $\Delta r$ ), the greater the conformity with an added load.

$$\Delta r = r_{unweighted} - r_{weighted}$$



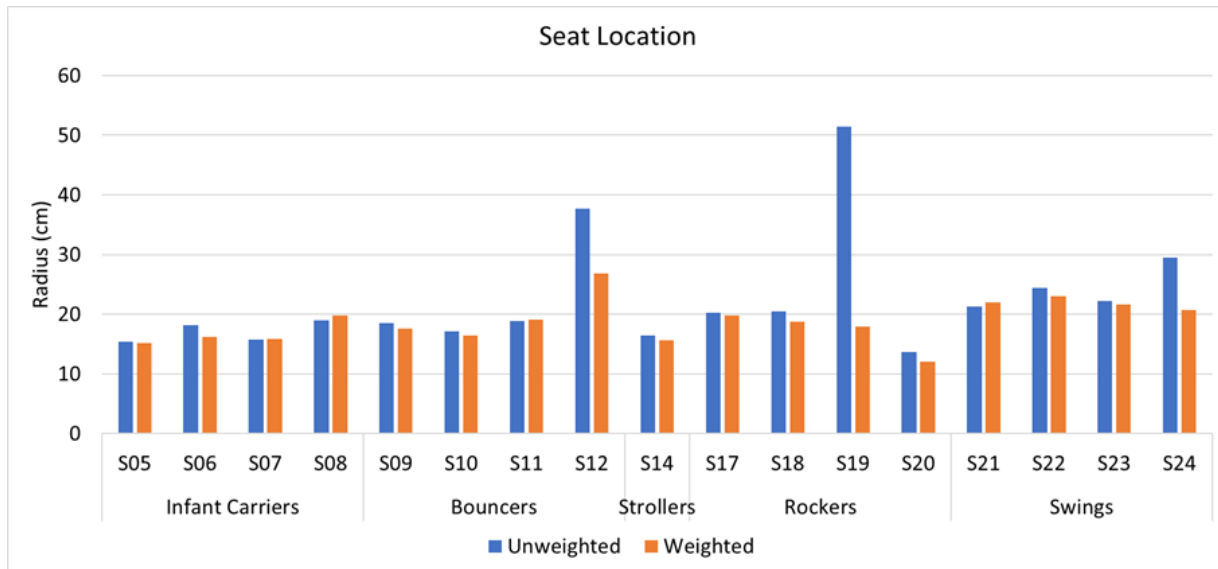
**Figure 21.** Example of the best-fit circle and the radius (r) for two different products, showing how the smaller radius correlates to a more concave product.

### 5.3 Concavity and Conformity Testing Results

All infant carriers, bouncers, rockers, and swings were successfully tested. Only one stroller was tested (S14, which featured an infant carrier design) because these measurements were not possible in the other stroller designs. No floor seats were tested since these products were also not conducive to the methodology. Concavity data at the head location is presented in **Figure 22**, while seat data is presented in **Figure 23**. The larger the radius, the flatter the product, and vice versa. A product which features a more concave surface would have a smaller radius.



**Figure 22.** The concavity of each product at the head location, with (weighted) and without (unweighted) the infant five-segment sagittal plane device in the intended position. The smaller the radius, the more concave the product. The S24 unweighted radius was 128 cm.

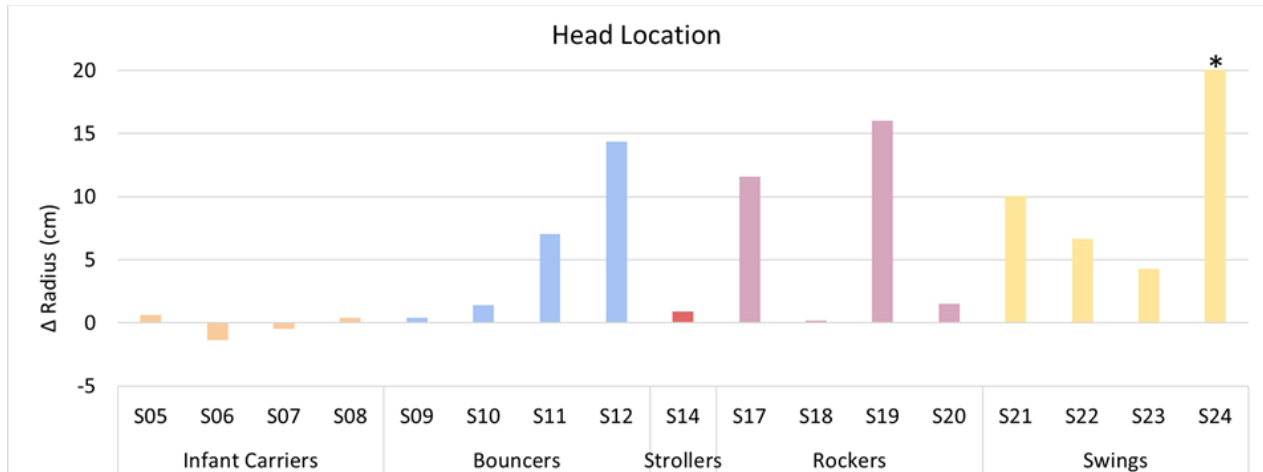


**Figure 23.** The concavity of each product at the seat location, with (weighted) and without (unweighted) the infant five-segment sagittal plane device in the intended position. The smaller the radius, the more concave the product.

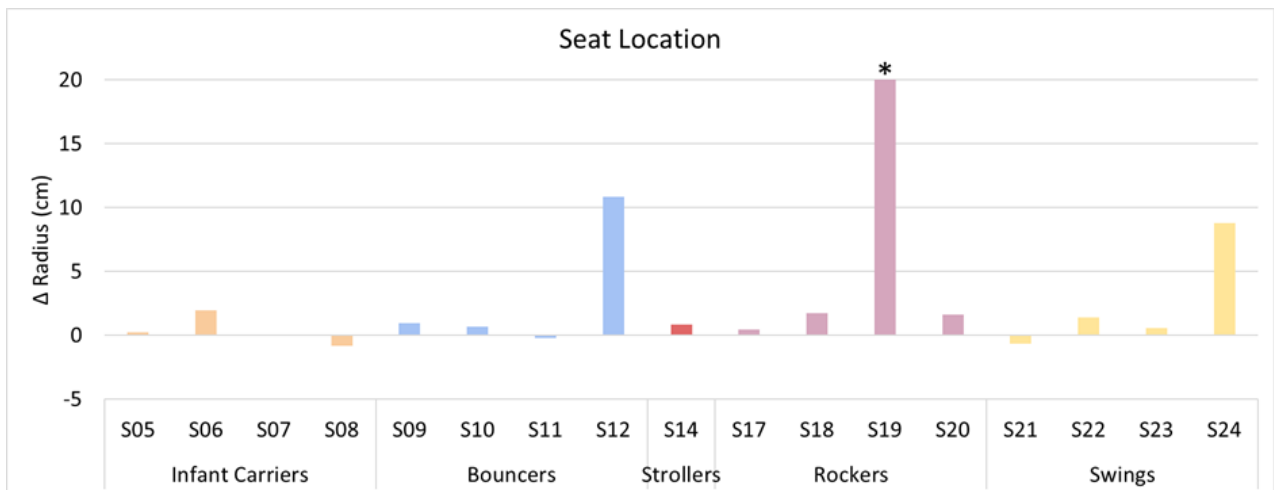
Some products featured nearly the same concavity measurements for both the weighted and unweighted conditions. For example, the infant carrier product category featured the most concave designs of all product categories with consistent values for both the weighted and unweighted testing conditions at both the head and seat locations. Other product categories varied, with some products featuring fairly flat surfaces while others in the same product category featured significant concavity.

Conformity data at the head location is presented in **Figure 24**, and at the seat location in **Figure 25**. The larger the change in radius, the more the product conforms to the added weight. For example, a solid surface like a wood floor would have zero change in radius, because the floor does not conform to the added weight – representative of an infant. Conversely, a conforming product like a soft pillow would feature a large change in the radius, indicative of a conforming surface which envelops the infant. All concavity and conformity data are presented in **Table 14** and **Table 13**.





**Figure 24.** The conformity of each product at the head location. The larger the change in radius ( $\Delta r$ ), the more conforming the product is to a load representative of an infant. S24 exhibited a large  $\Delta r$  of 103 cm, indicating it is a conforming product.



**Figure 25.** The conformity of each product at the seat location. The larger the change in radius ( $\Delta r$ ), the more conforming the product is to a load representative of an infant. S19 exhibited a large  $\Delta r$  of 20 cm, indicating it is a conforming product.

The conformity results indicate that other than the infant carrier category where all product featured low conformity, the conformity of products vary across product categories. Most bouncers had low conformity values, but the S12 bouncer conformed significantly to the weight. S12 features a plush and loose pillow feature, so when a weight is added, the center of the pillow feature compresses while the free edges conform to the weight which is representative of an infant’s body. A few products exhibited slightly negative conformity values, which is explained because the two-dimensional nature of the five-segment device actually pressed some features into a flatter position, which was most commonly seen in the infant carriers with the firm yet concave head and body inserts. This shows a

limitation of our primarily two-dimensional five-segment device – further motivating the need for more three-dimensional geometry, particularly at the head (see section 9).

**Table 13.** Concavity and conformity testing results for all products in the unweighted and weighted conditions in the head position, with the larger  $\Delta r$  values representing more conformity.

Category	Sample Number	Unweighted			Weighted			$\Delta r$
		Lc (cm)	M (cm)	r (cm)	Lc (cm)	M (cm)	r (cm)	
Infant Carriers	S05	33.3	9.2	19.7	34.9	10.1	19.1	0.6
	S06	29.9	10.6	15.8	33.3	11.6	17.2	-1.4
	S07	33.4	15.8	16.7	34.4	15.1	17.2	-0.5
	S08	30.6	8.2	18.4	31.8	8.3	18.0	0.4
Bouncers	S09	30.0	7.6	18.6	30.9	7.3	18.2	0.4
	S10	29.5	11.1	15.4	27.6	10.6	14.0	1.4
	S11	37.1	4.9	37.6	38.4	5.5	30.5	7.1
	S12	46.2	6.0	47.5	47.8	8.9	33.1	14.4
Strollers	S14	32.4	12.6	16.7	31.3	12.2	15.8	0.9
Rockers	S17	35.3	4.2	39.2	37.6	6.1	27.6	11.6
	S18	35.3	9.2	21.5	37.6	9.9	21.4	0.2
	S19	30.9	3.5	35.9	29.9	5.5	19.8	16.0
	S20	23.4	4.8	16.7	25.4	5.6	15.1	1.5
Swings	S21	38.2	8.1	26.6	28.2	6.6	16.5	10.0
	S22	31.9	4.6	30.0	31.2	4.7	23.3	6.7
	S23	19.5	2.3	21.8	19.0	1.5	17.5	4.3
	S24	26.7	0.7	127.7	24.5	1.9	25.0	102.6

**Table 14.** Concavity and conformity testing results for all products in the unweighted and weighted conditions in the seat position, with the larger  $\Delta r$  values representing more conformity.

Category	Sample Number	Unweighted			Weighted			$\Delta r$
		Lc (cm)	M (cm)	r (cm)	Lc (cm)	M (cm)	r (cm)	
Infant Carriers	S05	29.5	11.1	15.4	29.6	10.7	15.1	0.2
	S06	33.7	11.4	18.2	32.0	12.2	16.2	1.9
	S07	30.9	12.6	15.8	31.5	13.2	15.8	0.0
	S08	31.1	8.1	19.0	32.1	6.9	19.8	-0.8
Bouncers	S09	33.3	10.4	18.5	33.2	10.5	17.6	1.0
	S10	32.1	11.1	17.2	31.6	10.5	16.5	0.7
	S11	35.0	11.9	18.8	36.7	12.7	19.0	-0.2
	S12	44.3	7.2	37.7	43.6	9.9	26.8	10.9
Strollers	S14	32.7	14.9	16.4	31.1	12.9	15.6	0.8
Rockers	S17	36.1	11.1	20.2	38.2	13.3	19.8	0.4
	S18	36.7	11.4	20.5	34.5	10.1	18.8	1.7
	S19	32.3	2.6	51.5	31.2	7.8	17.9	33.5
	S20	23.9	7.1	13.6	23.2	7.7	12.0	1.6
Swings	S21	41.3	16.2	21.3	43.5	17.9	21.9	-0.7
	S22	44.4	14.3	24.4	43.8	14.7	23.0	1.4
	S23	37.8	10.6	22.1	38.7	10.7	21.6	0.5
	S24	44.1	9.9	29.5	38.1	11.3	20.7	8.8

## 5.4 Concavity and Conformity Testing Discussion

We evaluated the concavity and conformity testing results in conjunction with the head rotation results from section 4. These two tests should work in tandem. Both test methods are designed to identify products that increase the risk for suffocation due to mouth/nose contact with the side of a product during a normal head rotation during supine lying, or will increase the difficulty of freeing the mouth/nose to breathe if an infant completes a roll from supine to prone in the product. **Table 15** shows the combined results from the head rotation testing during intended placement from section 4.3 as well as the concavity results from the weighted condition in section 5.3.

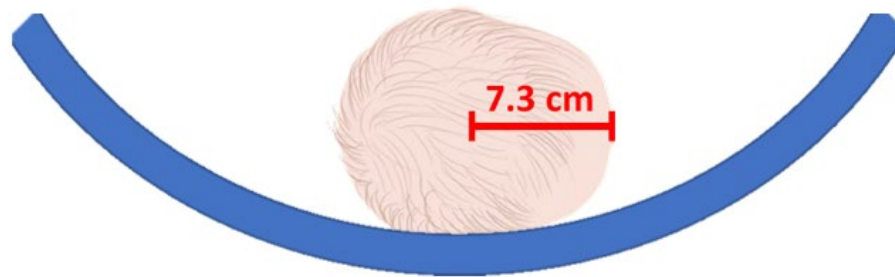
**Table 15.** Combined data from head rotation testing and the concavity measurement (*r*) from the weighted condition.

Category	Sample	Head Rotation	r weighted (cm)
Infant Carriers	S05	Pass	19.1
	S06	Fail	17.2
	S07	Fail	17.2
	S08	Fail	18.0
Bouncers	S09	Pass	18.2
	S10	Fail	14.0
	S11	Pass	30.5
	S12	Fail	33.1
Strollers	S14	Fail	15.8
Rockers	S17	Pass	27.6
	S18	Pass	21.4
	S19	Pass	19.8
	S20	Fail	15.1
Swings	S21	Fail	16.5
	S22	Pass	23.3
	S23	Pass	17.5
	S24	Pass	25.0

If we consider the 97<sup>th</sup> percentile 6-month old male infant head circumference (46 cm) from the CDC growth charts, and assume a circular cross-sectional shape, we can estimate the diameter or head breath (14.6 cm). Using the concavity measurement described above, this means that if a product had a radius of 7.3 cm, that the infant's face would be in direct contact with the product during a head turn. Since the interaction of the mouth/nose with the soft goods of a product introduces suffocation-related hazards, we suggest that the threshold for the concavity radius should be triple the amount of the



infant's head radius (7.3 cm), resulting in a 22 cm threshold. This corresponds to the concavity measure (r weighted), meaning that any product with concavity <22 cm would have too much concavity and would increase the risk for the infant's mouth/nose to contact the side of the product. As shown in **Figure 26**, the infant's mouth/nose is not in direct contact with the product and instead features space between the sides and the mouth/nose to facilitate free airflow for breathing.



**Figure 26.** Depiction of the top view of an infant's head showing a 7.3 cm radius, lying within a to-scale example of a product with a 22 cm concavity radius.

Note that all products that failed the head rotation test (except bouncer S12) also exhibited too much concavity (<22 cm). S12 features an extremely plush dog-shaped pillow feature that is tethered to the product by a thin strap, such that when an infant is placed into the product with a 90° head turn, the plush pillow actually contacts a significant portion of the face because it is not sewn into the surface of the product (similar to product S21 in the head rotation results – see **Figure 17**). However, the actual *structure* underneath the plush insert and pillow of the S12 bouncer featured the least amount of concavity in the products we were able to test (r weighted of 33.5 cm).

All products with a low risk for suffocation related to mouth/nose contact with the side of the product during a normal head rotation in supine lying featured no pillows or a smaller pillow feature, such as product S11 (**Figure 27**), though we note that even a smaller pillow could present a hazard if an infant's head is not centered within the product. Most products that we characterized as high risk for mouth/nose contact featured larger and thicker pillows or inserts, as in the case of product S21 (**Figure 27**).



**Figure 27.** Depiction of a smaller pillow in S11 resulting in no mouth/nose contact during supine lying with a head turn, compared to a larger pillow in S21 which results in mouth/nose contact.

## 5.5 Concavity and Conformity Testing Conclusions

We recommend that infant seated products feature no loose inserts or pillows, meaning that no portion of the product soft goods could cover the infant's face during intended supine lying with a normal head rotation. Adoption of a conformity measurement (r weighted) with a threshold of >22 cm as described above would prevent mouth/nose contact with seated products during supine lying with a normal head rotation, and it would make it easier for infants to free their mouth/nose for breathing if they rolled into a prone position within the product.

## 6. Firmness Testing

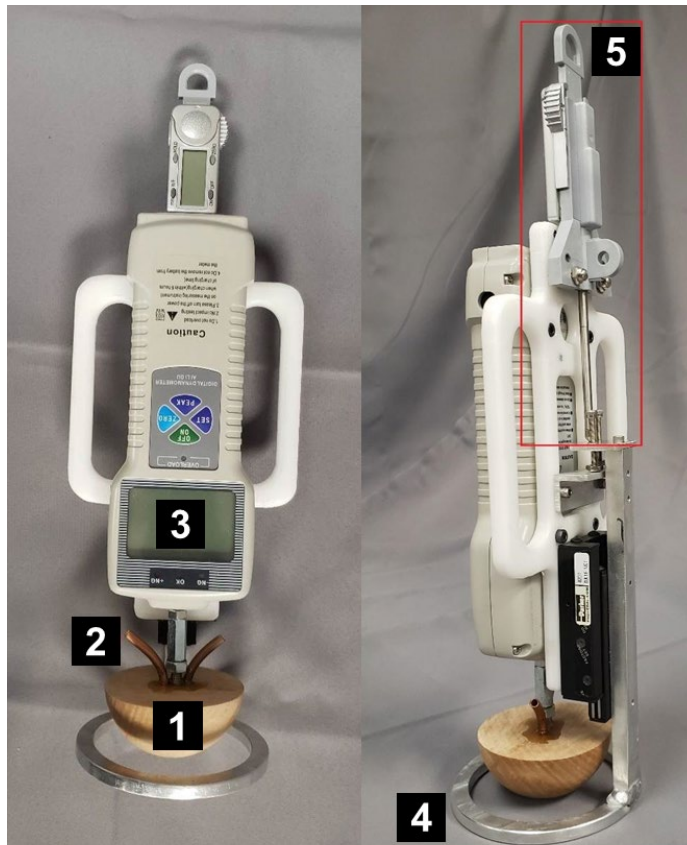
### 6.1 Firmness Testing Overview

The firmness of any product with soft goods that can possibly come into contact with an infant's face is an important consideration for suffocation-related safety. As previously discussed (see section 4.1), if a product is too soft, the infant's face can become enveloped in the product which can create suffocation-related hazards: (1) nasal occlusion if the product mechanically occludes the nares from inhaling, (2) increasing the resistance of airflow during inhalation, making the work of breathing more difficult on the infant; and (3) contributing to an abnormal exchange of gases during respiration, which could lead to hypercapnia (increased CO<sub>2</sub>) and/or hypoxia (decreased O<sub>2</sub>) . If a product is sufficiently firm, these hazard modes are essentially eliminated because the material cannot form a seal around the mouth/nose, and if the nose is fully occluded against a firm surface, slight movement from an infant's normal arousal response will free the nose for breathing. Thus, firmness is perhaps the most important factor in determining product safety in terms of materials that an infant's face may contact during foreseeable use. A sufficiently firm and flat product prevents a seal from forming or being maintained, reducing suffocation hazards related to nasal occlusion, resistance of airflow, and an abnormal exchange of gases.

The purpose of this section is to describe the development of a handheld firmness probe that can be used to evaluate the firmness of unusually shaped products like the 24 seated products in this study. We then use the handheld firmness tester to evaluate the firmness of six commercially available crib mattresses (as a representation of a safe level of firmness) and the 24 seated products.

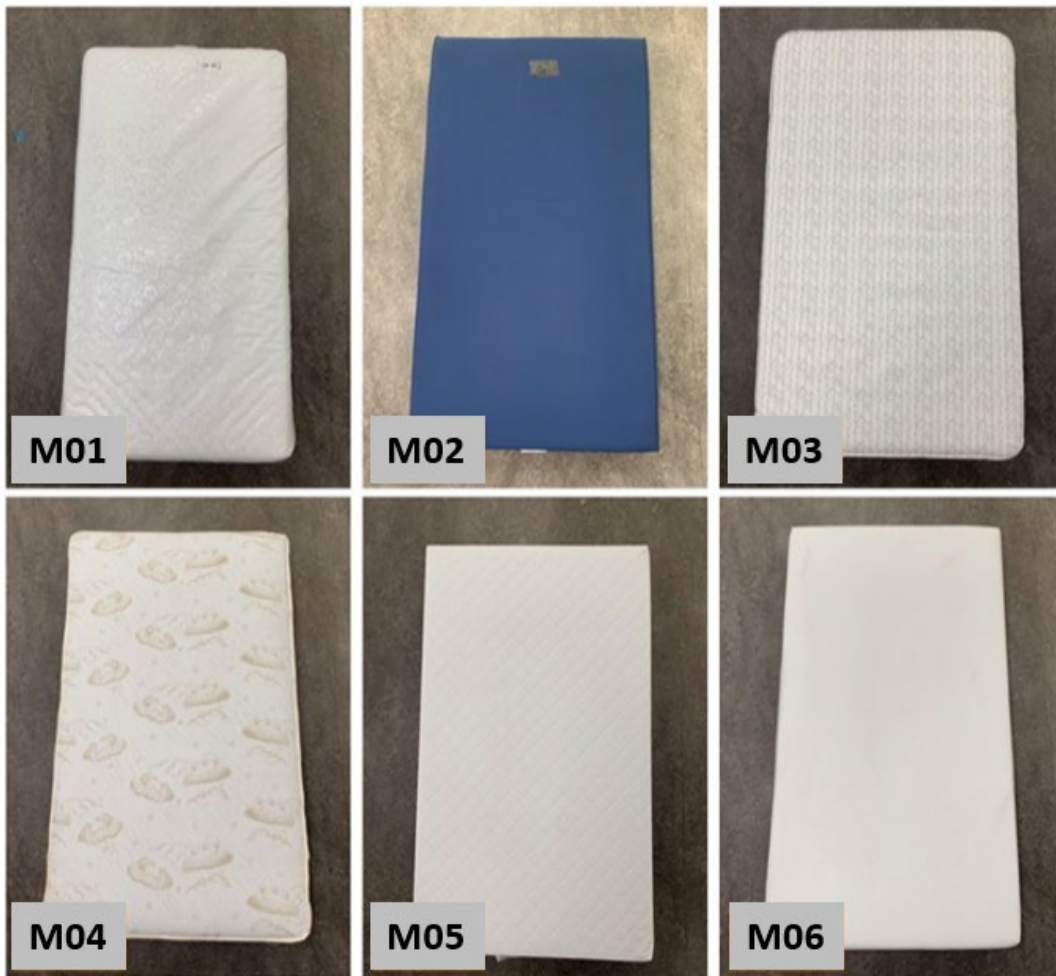
## 6.2 Firmness Testing Methods

In our previous work (Mannen et al., 2022), we developed a combination firmness and airflow testing device with a vertically guided lifter. While the device was useful for plush pillow-like products and crib bumpers, we were unable to use it with the seated products in this study due to the unique designs of the products featuring significant concavity and unusual non-uniform shapes. Therefore, we modified the vertically guided testing device into a handheld firmness and airflow tester (Figure 28). A 7.5 cm wooden hemisphere with two pieces of 3.5 mm brass tubing (used in airflow testing, see section 7 below for more details) was attached to the end of the force gauge (Ailigu ZP-50N; Shenzhen, Guangdong Province, China; range of 0 to 50 N;  $\pm 0.2\%$  accuracy). The size of the wooden hemisphere and the brass tubing representative of infant nares, corresponds to infant anthropometric data of the diameter of an infant face and nostrils (Mannen et al., 2022). A 10 cm outer diameter, 8.5 cm inner diameter, and 0.75 cm thick aluminum circular footprint was machined and fixed to the handheld firmness tester, aligned with the hemisphere. The shape and size of the footprint was chosen because it is slightly larger than the diameter of the hemisphere, allowing us to measure the relative displacement of the hemisphere with respect to the footprint. The circular foot and force gauge were coupled through a ball bearing linear slide. A digital depth gauge (iGaging, Los Angeles, CA, Range 0-100 mm, accuracy 0.025 mm) was fixed to the device to measure vertical displacement. A three-dimensional rendering and engineering drawings for the housing components of the device are presented in Appendix B.



**Figure 28.** Handheld firmness tester featuring (1) wooden hemisphere; (2) copper tubing used for airflow testing; (3) force gauge; (4) circular aluminum footprint; and (5) depth gauge.

For each firmness test, a 0.25 N load was first applied, representing a preload, and the depth gauge was zeroed. In our previous research on infant pillows and loungers (Mannen et al., 2022), we used a 0.1 N preload with the vertically guided lifter device. Because of the handheld nature of our new handheld firmness device, it was difficult to consistently maintain a 0.1 N load; thus a 0.25 N load was used as our preload. Then, the handheld firmness tester was pressed into the product to a 10 N force and held steady for 30 seconds when the displacement measure was recorded. Firmness testing was conducted on six standard infant crib mattresses to determine a safe threshold for displacement (Figure 29). Since crib mattresses are considered a safe product for infant sleep, we tested each infant crib mattress three times, and calculated the mean. Then, the mean and standard deviations of the six mattress products were calculated in order to set an appropriate firmness threshold.



**Figure 29.** Crib mattresses used to determine firmness threshold using handheld firmness device.

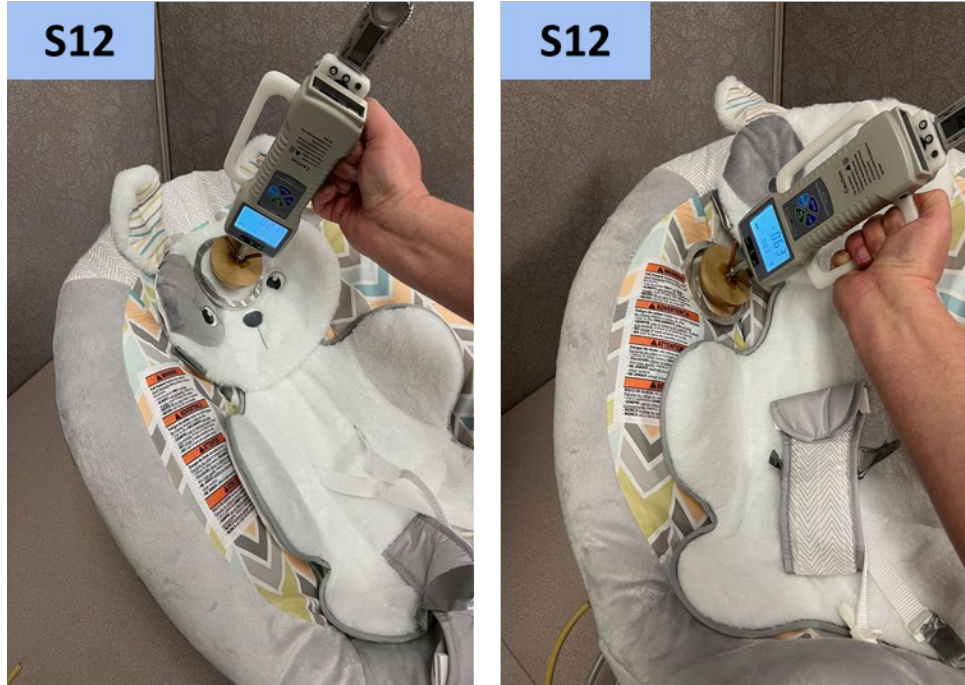
For the 24 seated products, we conducted firmness testing simultaneously with airflow testing (see section 7). We completed three firmness trials at two locations: (1) a prone position which represents a scenario where the infant would be placed prone or rolled from supine to prone, and (2) a supine position representing the first contact an infant would have with the product upon head rotation in the axial plane (or with forward flexion in the case of the infant floor seats). We chose worst-case locations for testing (most plush) when plausible. Time was allotted between trials to allow the products to settle. **Figure 30** shows an example of the prone and supine testing locations on select products. **Figure 31** shows an example of firmness testing in both the prone and supine locations. Mean and standard deviations were calculated.





**Figure 30.** Photos showing the prone (P, red circles) and first contact supine (S, yellow circles) locations for firmness and airflow testing on a representative seated product from each product category.

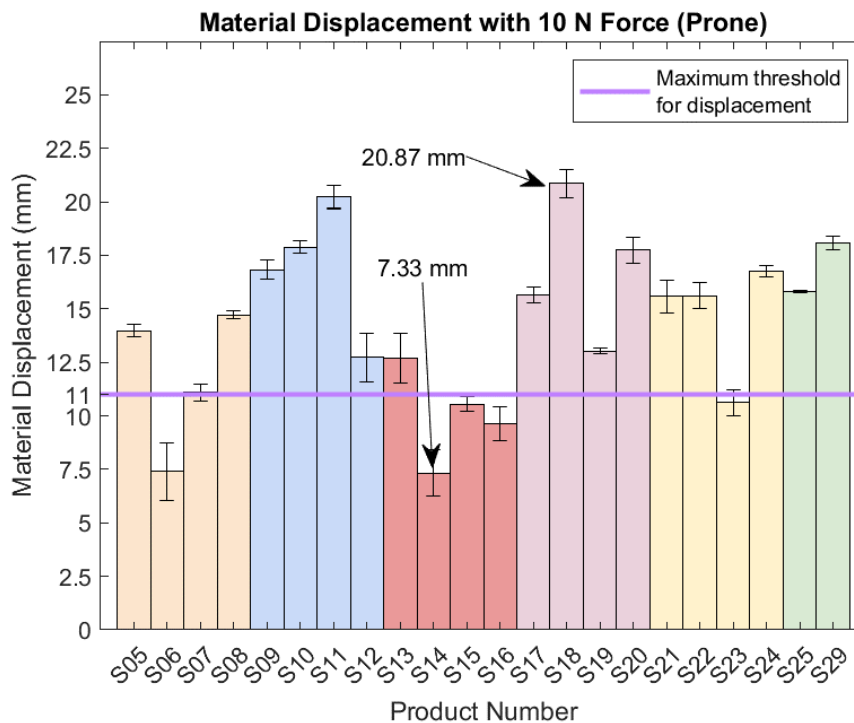




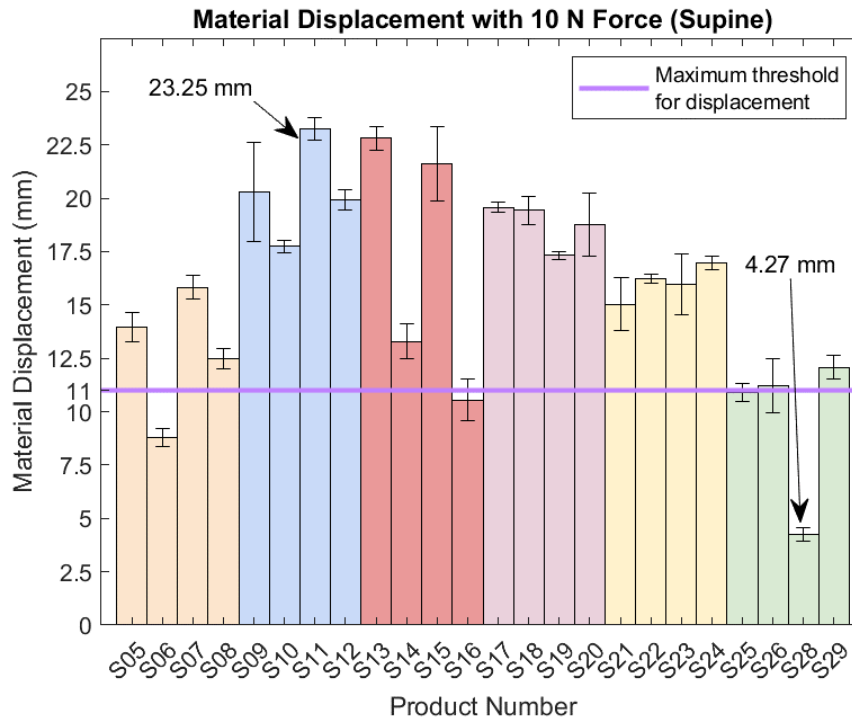
**Figure 31.** Firmness testing on bouncer S12 with handheld device at (Left) the prone position, and (Right) the first contact supine position. During testing, we used both hands to apply force. Only one hand is used in these photos to better visualize the testing location.

### 6.3 Firmness Testing Results

The displacement results for the six crib mattresses we tested indicated a displacement of  $8.0 \pm 1.5$  mm at the 10 N load after displacement was zeroed at the 0.25 N preload. All six crib mattresses we tested fell within  $\pm$  two standard deviations of the mean, therefore we set the threshold for a safe displacement with our handheld firmness device at 11.0 mm. We note that this threshold value is approximately 14 mm lower than the threshold we developed in our testing as part of the Characterization and Testing of Infant Pillows (Mannen et al., 2023). This difference is expected, and is explained due to the differences between the two firmness devices. The vertically guided lifter device from our previous report measures absolute distance, while this handheld device measures the distance relative to the footprint which also may sink into the product a few millimeters as the hemisphere deforms the material. The firmness results of all seated products in the prone location are shown in **Figure 32**, and in the supine location are shown in **Figure 33**.



**Figure 32.** Firmness testing results in the prone position where the aqua line represents the 11 mm displacement threshold. We did not identify a prone location for products S26 and S28.



**Figure 33.** Firmness testing results in the supine position where the aqua line represents the 11.0 mm displacement threshold.

Most products measured above the firmness threshold, meaning they are softer than a crib mattress. Of note, the stroller category of products had the firmest back support, with 3 of the 4 products meeting the firmness threshold in the prone location. However, the same was not true of the strollers at first contact in the supine location, where 3 of the 4 products displayed much higher displacement, failing the firmness test. The floor seats were firmer at the supine location of first contact, and the prone location was softer and difficult to identify due to the product designs. Other product categories exhibited fairly consistent results in both the prone and supine locations, with almost every other product featuring softer designs compared to a crib mattress. Product S06 passed the firmness test in both the prone and supine locations. This infant carrier features a unique firm foam material.

## 6.4 Firmness Testing Discussion

Firmness testing of infant products can identify hazards related to suffocation. The handheld firmness device that we developed enabled us to assess the firmness of the seated products compared to a crib mattress. All bouncers and rockers failed our proposed firmness test, meaning the deformation of the products under a load similar to the weight of an infant's head greatly exceeds the deformation of that same load on a crib mattress. This means that the product introduces a greater risk for hazardous mouth/nose interactions with the product. Common characteristics of products which failed firmness testing are slung or hammock types of designs, which featured a metal or plastic frame with soft goods fixed to the frame but no structural support underneath the infant's head or body other than the soft goods. Other products that failed feature large body inserts and pillows.

Most strollers had more structural support underneath the infant, with little or no support on the sides other than a single textile layer which is why most strollers were firm enough in the prone testing but failed in the first contact supine testing. Stroller S13 was an anomaly – it featured a softer foam support underneath the infant, causing it to fail the firmness test.

Infant carrier S06 (which doubles as stroller S14) features a thin and firm pillow insert with a stiff plastic support backing that is unique. This design feature may explain why this product passed the firmness test in the prone position.

Firmness can also influence the effectiveness of an infant's arousal response, especially during prone lying. If an infant's arousal response is triggered during prone lying, the infant will move. On a firm and flat crib mattress, this arousal response is likely enough to free the mouth/nose for breathing. However, in products that are not sufficiently firm, the movement triggered by the infant's arousal response may not be enough to free the mouth/nose for breathing, resulting in a hazardous suffocation risk.

## 6.5 Firmness Testing Conclusions

We recommend a firmness test be performed for infant seated products using a handheld device like the one we developed. To reduce the potential for suffocation, products should exhibit firmness of <11 mm with a 10 N applied load.

We previously recommended a similar firmness test for infant pillow products using a vertically guided lifter firmness device with a different threshold based on crib mattress testing (Mannen et al., 2022). While the overall concept of these tests is similar, the actual test devices (and thus threshold values) are different, which justifies the varying thresholds. Our handheld firmness device features a circular aluminum footprint which does deform with the product by a few millimeters. However, due to the concave and unusual shapes of the seated products, this handheld method offers advantages over the vertical lifter method for firmness testing.

We have concerns related to slung or hammock style products which feature soft goods fitted over a rigid frame. The lack of structural support underneath the infant leads to lack of firmness and conforming characteristics, which both have negative implications for suffocation and positional asphyxia. It is also known that materials degrade over time, and in the case of these products, most likely will become looser which introduces even higher risks.

Because of the range of materials and material combinations used in infant products, it would be beneficial to perform a systematic and controlled experiment of common materials and material combinations to better inform the industry on how the selection of materials for their products will influence suffocation-related characteristics like firmness.

## 7. Airflow Testing

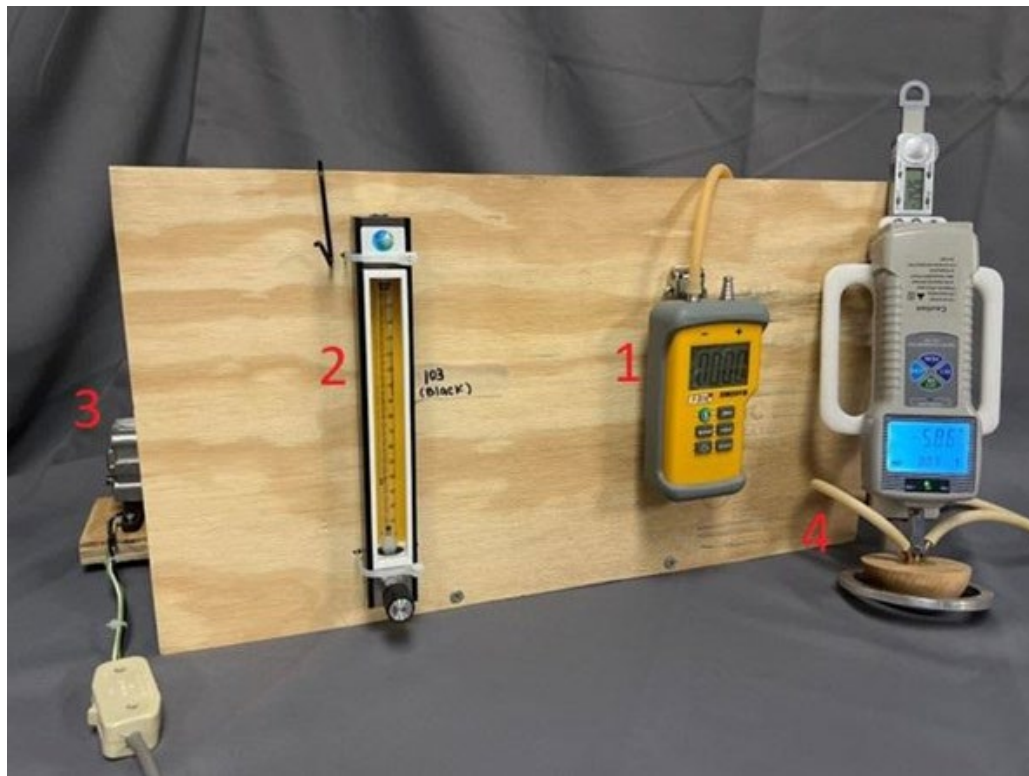
### 7.1 Airflow Testing Overview

The airflow of products is one aspect of identifying suffocation hazards in infant products. As previously discussed, suffocation hazards related to breathing into a product can be attributed to full mechanical nasal occlusion, airflow resistance, or an abnormal exchange of gases. Airflow testing addresses the airflow resistance hazard specifically. For example, if an infant's face is completely enveloped by a mesh-like material that exhibits nearly-free airflow, even though a seal may have formed between the infant's face and the material, because there is free airflow, the infant will not experience suffocation due to airflow resistance.

Thus, airflow testing can elucidate products or materials which may resist airflow in a way that could be hazardous if an infant comes into contact with the product, especially if they are in a more vulnerable sleep state. The purpose of this section is to conduct airflow testing on the 24 seated products, and to evaluate the data in combination with the firmness data to understand how or if airflow is an important test to evaluate suffocation-related hazards in seated products.

## 7.2 Airflow Testing Methods

We previously developed a vertically guided combination firmness and airflow testing lifter device (Mannen et al., 2022), where the airflow test design was based on the Australian/New Zealand Standard 8811.11:2013, using a lower flow rate of 2 L/min to more closely represent infant volumetric inhalation rate (U.S. EPA, 2009; Carleton, 1998; Maltese, 2019) and nare sizes of 3.175 mm made of copper tubing which more closely represent those of infants (Haase et al., 2021; Mazmanyany et al., 2020; Sivieri et al., 2013). Two six-inch lengths of rubber tubing were connected to the copper tubing and were then joined together with a T-fitting that connected to a flow meter (**Figure 34**).



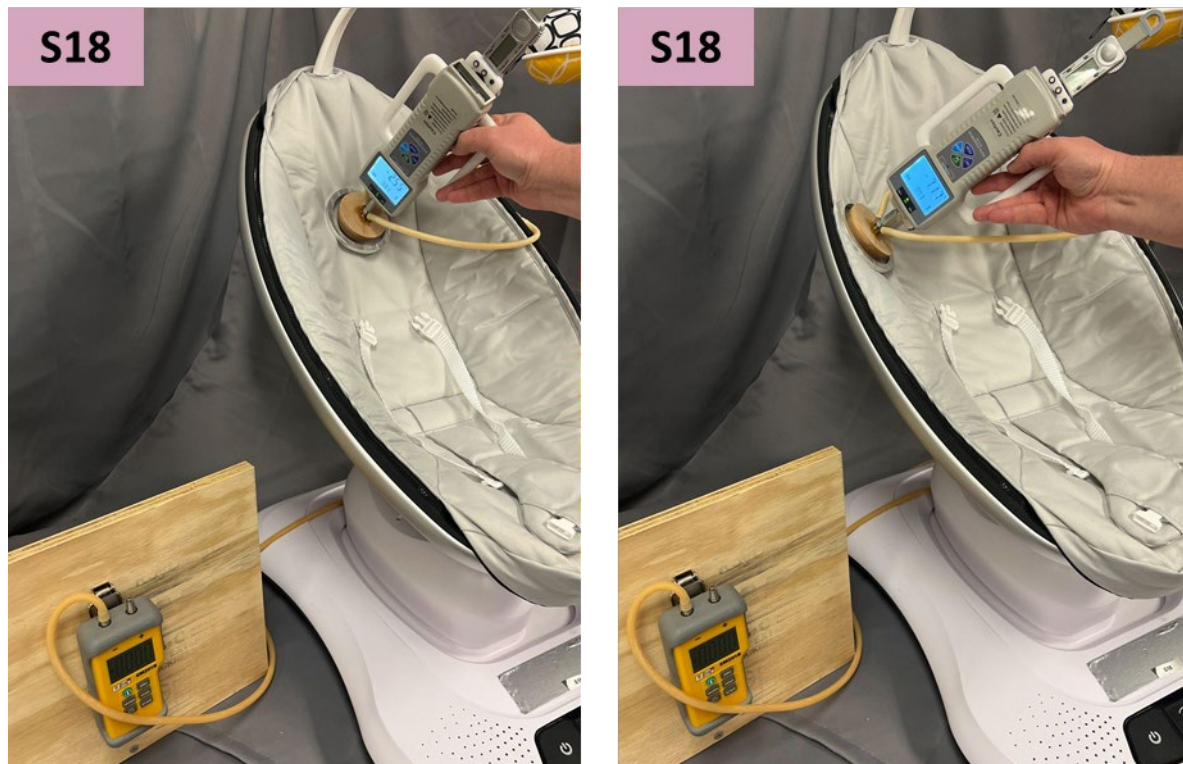
**Figure 34.** Airflow apparatus featuring (1) digital manometer, (2) flowmeter, (3) pump, and (4) handheld firmness and airflow testing device.

For the 24 seated products, we conducted airflow testing simultaneously with firmness testing (see section 6). We completed three airflow trials at two load levels (0.25 N preload representing contact with the product, and a 10 N load) at two locations: (1) a prone position which represents a scenario where the infant would be placed prone or rolled from supine to prone, and (2) a supine position representing the first contact an infant would have with the product upon head rotation in the



axial plane. The same locations used in firmness testing were used in this airflow testing. Time was allotted between trials to allow the products to settle.

During each test, the probe was held in place by a researcher for 30 seconds while the air pressure measurement was recorded by drawing air through the airflow apparatus (**Figure 35**). Mean and standard deviations were calculated for both applied loads (0.25 N preload; and 10 N load representative of an infant's head) in both test locations (prone and supine). We compared this data to a threshold value we previously established using the same airflow testing apparatus on mesh crib liners, where we found that mesh-like airflow resulted in a pressure drop of 0.31 inches of water (in H<sub>2</sub>O) with a 10 N applied load, and any higher pressure values than this threshold indicated that there was less airflow (Mannen et al., 2022). We also plotted firmness vs. airflow results for each product, and assessed the data.

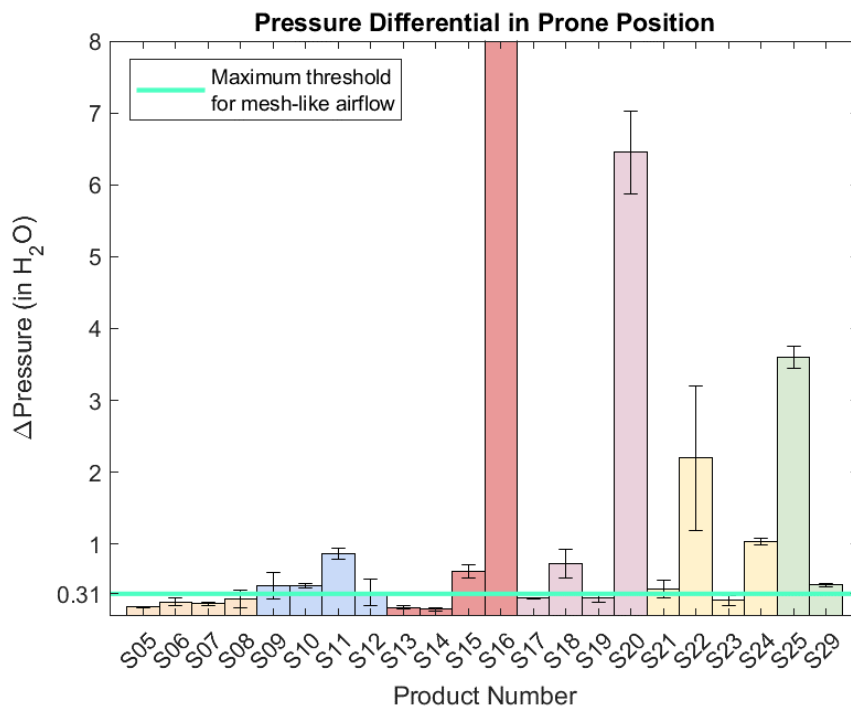


**Figure 35.** Airflow testing using handheld device on swing S18 in the (Left) prone position, and (Right) first contact supine position.

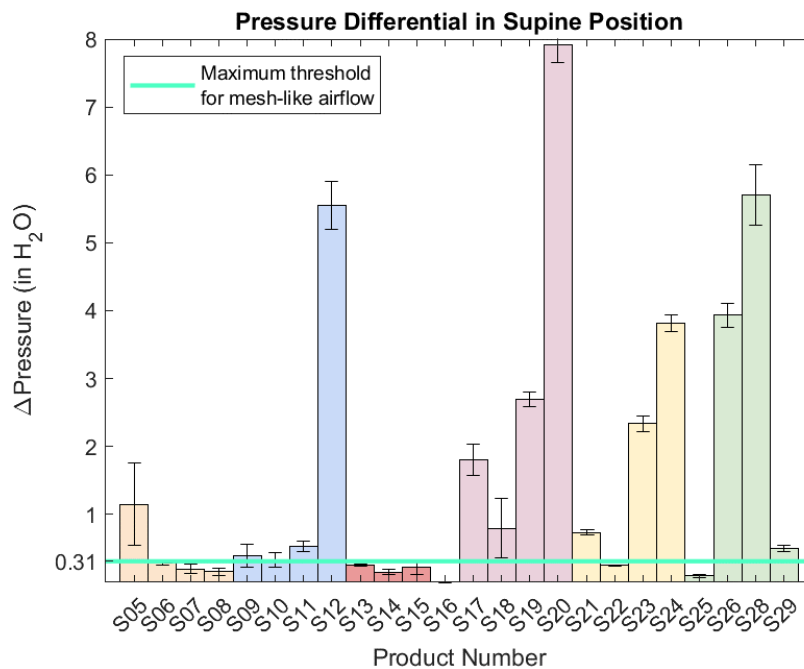
### 7.3 Airflow Testing Results

Overall, airflow results were variable, but we noted some trends. Results are presented below - **Figure 36** shows the prone position under a preload; **Figure 37** shows the prone position under a 10 N load; **Figure 38** shows the supine position under a preload; and **Figure 39** shows the supine position under a 10 N load.

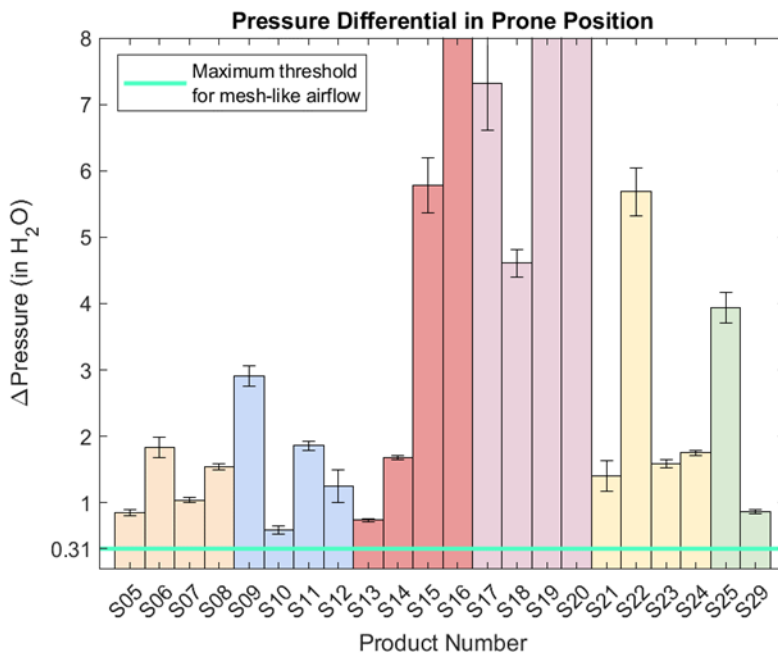
All products resulted in airflow resistance with a 10 N load applied, meaning that suffocation via nasal occlusion or resistance to airflow would be a concern if the weight of an infant's head was applied to the product. Some products fell below the mesh-like pressure threshold on first contact (0.25 N preload condition), meaning that airflow would not be influenced if an infant's face was gently touching the surface. In the supine and prone positions, at first contact (0.25 N preload), most infant carriers fell below the threshold for mesh-like airflow, meaning airflow was not obstructed. However, with the application of a 10 N load, airflow was negatively influenced as the pressure differentials were well above the mesh-like airflow.



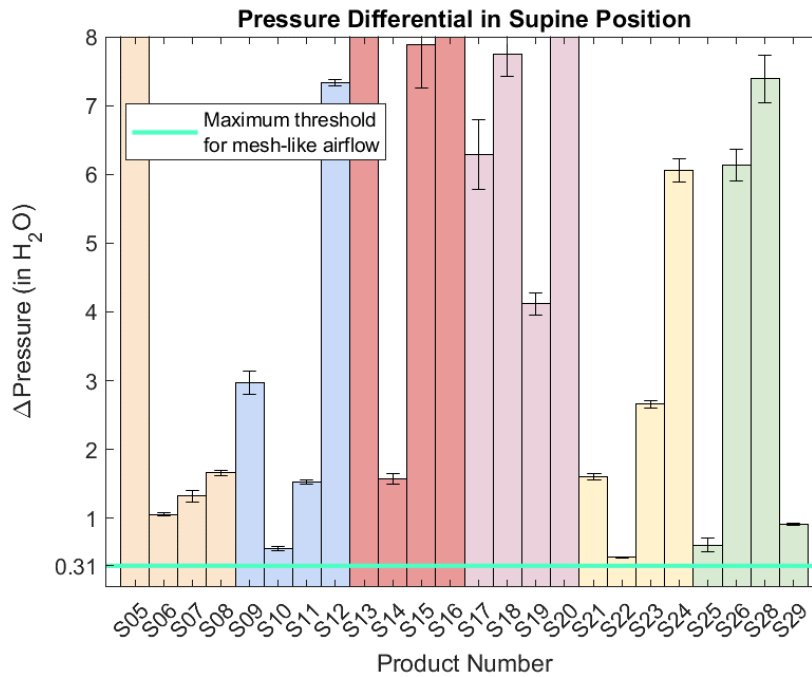
**Figure 36.** Airflow testing results in the prone position at first contact (0.25 N preload) for all products where any pressure values below the aqua line represents mesh-like airflow. S16 exhibited 16.2 in H<sub>2</sub>O.



**Figure 38.** Airflow testing results in the supine position in first contact (0.25 N preload) for all products where any pressure values below the pink line represents mesh-like airflow.



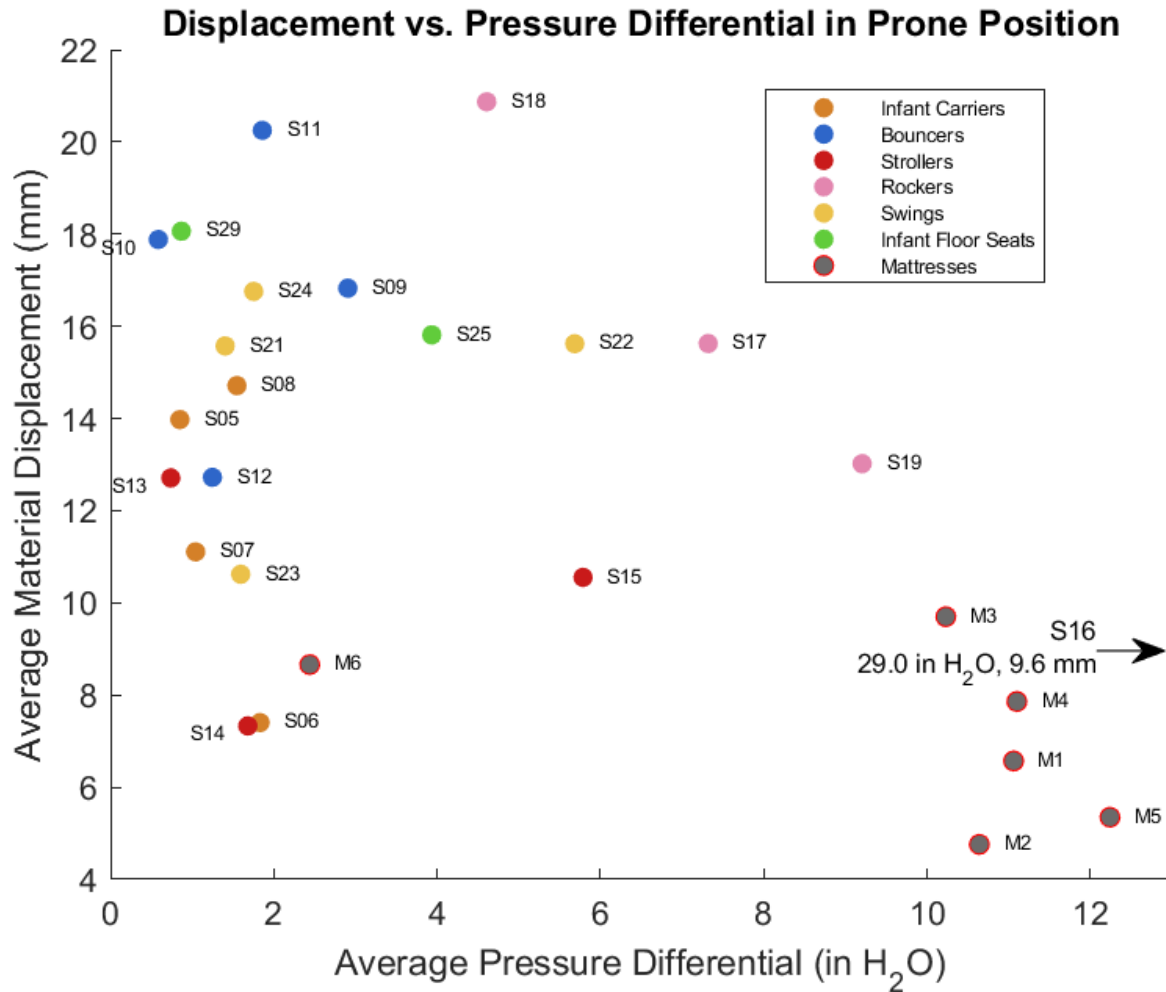
**Figure 37.** Airflow testing results in the prone position at a 10 N load for all products where any pressure values below the aqua line represents mesh-like airflow. S16 exhibited 29.0 in H<sub>2</sub>O, S19 9.2 in H<sub>2</sub>O, and S20 9.4 in H<sub>2</sub>O.



**Figure 39.** Airflow testing results in the supine position with a 10 N load for all products where any pressure values below the pink line represents mesh-like airflow. S05 exhibited 17.8 in  $H_2O$ , S13 18.0 in  $H_2O$ , S16 26.7 in  $H_2O$ , and S20 9.3 in  $H_2O$ .

In general, no products passed the airflow tests with the 10 N load. However, most infant carriers and a few other seated products across the product categories exhibited mesh-like airflow at the 0.25 N preload condition, likely due to the firmness of the products preventing the nares on the airflow probe from obstruction due to a very light load.

The firmness vs. airflow scatterplots for the prone and supine locations are shown in **Figure 40** and Figure 41. In these plots, products closer to the x-axis are firmer, and products closer to the y-axis exhibit better airflow (lower pressure differential). The products closest to the origin would be considered the safest products from an airflow and firmness perspective alone.



**Figure 40.** Scatterplot of firmness vs. airflow for each product in the prone position with a 10 N applied load.

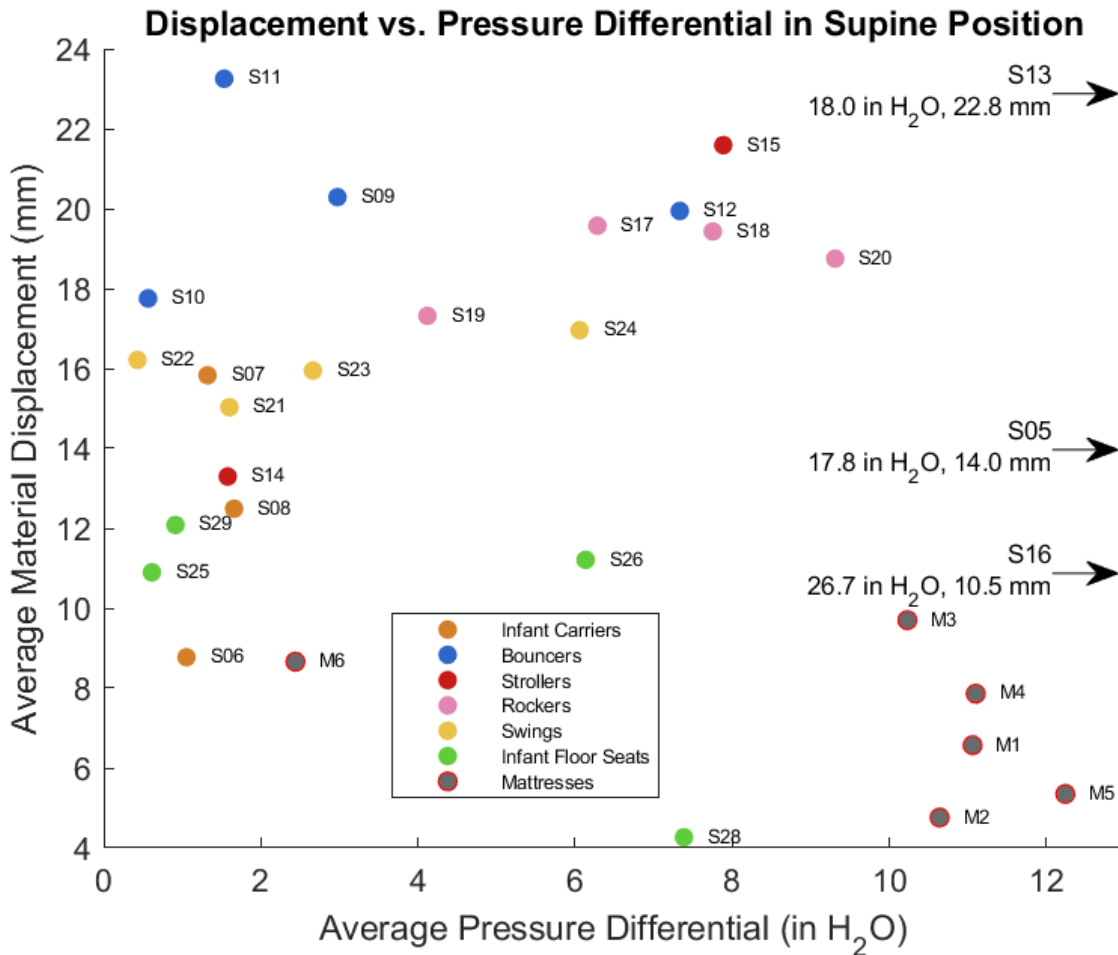


Figure 41. Scatterplot of firmness vs. airflow for each product in the first contact supine position.

Considering both firmness and airflow together, we see that the few products that exhibited firmness <11 mm (the threshold discussed in section 6) at both the first contact and prone positions (infant carrier S06, infant floor seat S28, and stroller S16), all exhibit concerning airflow characteristics under a 10 N load. On a firm and flat crib mattress, a product that is firm but does not pass an airflow test is still not a high suffocation hazard because if an infant experienced moments of nasal occlusion or high resistance to airflow, their normal arousal response would cause movements which would free the mouth/nose to enable free breathing. However, because these seated products are not firm and flat, we must consider all of the data cohesively, as the shape of the product must now be considered in addition to simply the airflow and firmness. We will discuss this further in section 7.4.

Product S06 airflow and firmness tests in both prone and first contact supine were conducted on the same component of the product, the “head pillow”. This part of the product is reported by the

retailer to be comprised of 67% plastic stiffener, 20% polyurethane foam padding, and 13% polyester fiber batting. While some of the other tested products also report using plastic stiffeners, the percent mass of the plastic stiffener used in product S06 is much greater than the next highest use by mass of 8% as found in product S07. Polymer stiffening agents such as those that may be used in the manufacture of the S06 head pillow are utilized to increase the stiffness of textiles (Decon, 2022). Textiles to which plastic stiffener (textile stiffening agent) is applied will have a lasting stiffness unless dampened with water where the material is flexible until dry (Decon, 2022).

Products S06 and S14 had very low material displacement and pressure differential compared to the other products and product categories, indicating that these products may be safer from an airflow and firmness perspective than the other tested products. Product S06 is an infant carrier with a padded frame and removable pillow inserts for the head and body. This product is designed to be attached to certain types of strollers for transitions from a vehicle to walking with a stroller. S14 is a stroller that is compatible with S06 (both products are produced by the same manufacturer). Considering this stroller is designed to accept the S06 infant carrier and similar products, the characteristics of concern for this product are the same as with product S06 as an infant would be seated in the same position for both. The test positions for both products were performed in similar locations (on the head pillow for both prone and first contact supine). As discussed earlier, the head pillow component of these products is comprised of portions of polyurethane foam, polyester fiber batting, and plastic stiffener.

Conversely, products such as S19 and S20 which are both rockers exhibited large material displacements during firmness testing (high on the y-axis) and low airflow during airflow testing (further right on the x-axis) for both prone and first contact supine trials, indicating that these products lack firmness and restrict normal airflow. When considering a sleeping infant, facial contact with products like these will seriously increase the risk of suffocation by the likelihood of the mouth/nose being enveloped by the product and then by restricting airflow. S19 features a height-adjustable design, elevating the product above the ground. The material for this product was 100% new polyester. The frame is covered in a plush material with another plush material placed under the infant's body and a pair of padded straps to restrain the infant in the seat. The prone measurements for S19 were taken on the thickest part of the body pillow, and the first contact supine measurements were taken against the plush frame material. Product S20 is a ground seated rocker made from 100% new polyester fiber (insert pad and infant insert). The insert component sits on a mesh fabric frame. Measurements for both prone and first contact supine trials were taken on the polyester insert. Prone measurements were taken



facing directly into the insert, and supine measurements were taken against the thicker rolled edge of the insert. Both products had very plush, soft surfaces that were easily displaced under load and were made of 100% polyester material. Product S20 also resulted in mouth/nose contact with the side of the product during the head rotation test (section 4, above), meaning that these hazardous soft and airflow-restrictive characteristics are present for an infant during intended placement at a 90° head turn.

## 7.4 Airflow Testing Discussion

Quantifying the resistance to airflow through a seated product can identify product designs or materials which may resist airflow in a way that could be hazardous if an infant's face comes into contact with the product, especially if the infant is in a more vulnerable sleep state. Using this test method, none of the products passed the airflow test with a 10 N load applied, meaning that if an infant's face was pressed against the side or headrest portion of the seated product with a force approximately equal to the weight of an infant's head, that airflow would be more restricted compared to free breathing or to breathing through a mesh-like material. On a firm flat crib mattress, we also know that airflow is restricted in a similar way, yet the difference is the design of the products. A crib mattress is firm and flat, meaning that if an infant's mouth/nose is mechanically occluded or if they are breathing through a material with restricted airflow, that their arousal response will result in movement to free their mouth/nose to enable breathing. Thus, airflow, or more accurately the lack of airflow, through a crib mattress is not a hazard in and of itself due to the design of the firm flat crib mattress enabling infants to easily self-correct and free their mouth/nose. Even with the interaction of the crib mattress and the rigid crib slat, if an infant's mouth/nose were to become fully mechanically occluded by the mattress or the crib slat, because both of these features are firm and flat, the infant's arousal response would still likely free their mouth/nose for breathing with a slight movement. However, because many of the seated products in this study feature significant concavity (see section 5), the issue of self-rescue if an infant is found prone becomes more concerning. Rather than a slight movement caused from an innate arousal response, an infant must maneuver their heads in much larger movements to overcome the concavity and conformity that some of these product feature. In these cases, the lack of airflow can be deadly.

The lack of airflow results in the seated products are not surprising – like other product categories we have evaluated (crib bumpers and infant pillows), infant products typically resist airflow. Products may be designed or marketed as “comfortable” for infants, which typically means there are plush soft goods within the surface or head rest area. Plush soft goods are typically not conducive to free airflow, and our results in this study agree with that.

We thought that the firmness and airflow measures may be related in these products, but our results do not support that idea. When we reviewed the combined airflow and firmness graphs (**Figure 40** and **Figure 41**), we observed that swings, bouncers, and rockers are somewhat clustered together

compared to other product categories. This could be due to similar features in these seated products – many featured plush body inserts or pillows. The seated products we evaluated are made of a variety of soft goods including cloth covers and filling made of polyester, polyethylene (PE), and polyurethane (PU) and in various forms such as fiber batting, plastic films, padding foam, and pillows. These material types and the product features they are used in have variable density based on their crystalline structure which influences both their firmness and the resistance to airflow (pressure drop) for any given thickness of material (Callister and Rethwisch, 2014).

Some products exhibited free airflow with the 0.25 N preload representing first contact with the side or back of the product, while other seated products already exhibited concerning airflow restrictions (high pressure drops). This means that if infant's faces are just barely in contact with the product, that airflow could be restricted. We again believe this is more of a firmness problem than an airflow problem. For the infant carriers, the products with the firmest soft goods, the airflow at the 0.25 N preload was under the threshold, meaning that infants would be able to breathe normally if their mouth/nose was just in contact with the side of the products. Conversely, products with covers and surface materials that were loose, or pillows that were only tethered and not sewn into the surface of the product resulted in high resistance to airflow (high pressure) with just a 0.25 N preload. This means that these products increase the risk that an infant may experience airflow resistance during breathing, even when their mouth/nose is just barely in contact with the surface. Even with these results in mind, the results of this airflow test can be attributed to the loose surface materials and/or the concave shape of the product.

While likely related to airflow, the exchange of gases during normal breathing was not studied in these seated products. Future work should focus on quantifying how products may affect the normal exchange of gases during breathing, and if airflow is correlated with this exchange.

## 7.5 Airflow Testing Conclusions

We do not recommend an airflow test for seated products at this time, and instead recommend a focus on firmness and then concavity to reduce the likelihood that the material could create a seal around an infant's face, and that the infant would not be able to maneuver out of a position where their mouth/nose is in contact with the soft goods of a seated product. Materials for each part of the product should be disclosed to the consumer. Finally, materials, including pillow features and covers, should be completely fixed to the surface and not loosely attached or tethered.

A comprehensive assessment of materials, combinations of materials, and surface support materials. Eliminating the variables introduced by the broad range of product designs would enable manufacturers to choose materials for their products which exhibit the best material properties to minimize the risk of suffocation to infants.

## 8. *In vivo* Human Subjects Testing

### 8.1 *In vivo* Human Subjects Testing Overview

While bench-top and test lab style evaluations of infant products can be useful in identifying some hazards, the way an infant interacts while positioned in seated products can clarify other factors. Body position affects breathing in numerous ways in infants and young children. Studies of supine vs. prone body position have reported differences in respiratory rate, heart rate, apnea frequency, apnea types (central vs. mixed or obstructive), upper airway collapsibility, thoraco-abdominal synchrony, frequency of arousal from sleep, hypoxia-induced arousal threshold, respiratory system mechanics, distribution of ventilation, response to mechanical loading of the respiratory system, ventilatory drive, response to CO<sub>2</sub>, body temperature, and oxygen consumption (Ammari et al., 2009; Bhat et al., 2003; Horne et al., 2002; Hough et al, 2016; Oishi et al, 2018; Saiki et al, 2009; Smith et al., 2010; Wolfson et al, 1992). Neck flexion is associated with increased total pulmonary resistance in both supine and semi-sitting positions while neck extension lowers pulmonary resistance in the semi-sitting position (Carlo et al., 1989). One study found that neck-flexion angles of just 45° significantly increased airflow interruption and increased severe airflow interruption compared to the neutral or flat surface position (Reiterer et al., 1994). Breathing was also affected for some infants at 45° of hyperextension. Similarly, neck flexion lowers specific lung compliance in infants in a semi-sitting position. Other studies indicate that neck flexion can cause complete pharyngeal closure in infants (Reed et al., 1985; Thach and Stark, 1979; Tonkin et al., 2003). Medical literature overwhelmingly agrees that head-neck flexion or hyperextension and trunk flexion influences normal breathing in infants and can contribute to positional asphyxia (Horemuzova et al., 2000; Roberts et al., 1985; Stark and Thach, 1976; Thach and Stark, 1979; Tonkin et al., 2003), yet little is known about how common infant seated products influence the body position of infants.

The mechanical environments that infants are exposed to also influence the movements they can make. Our previous research shows that infants use different muscles during prone lying on inclined surfaces (Wang et al., 2020), within inclined sleep products (Wang et al., 2021), and during rolling (Siegel et al., 2023). Body positions and the features of inclined products can enable infants within inclined environments to roll before they exhibit that same behavior on a firm flat surface. Other research has found that developmental activities like reaching and walking are also influenced by environment (Savelsbergh and van der Kamp, 1994; Thelen, 1986). Thus, understanding the body positions and muscle activity of infants in the environments of seated products may offer insight into movement

capabilities within the products. Furthermore, the mouth/nose interaction of infants with their environment can introduce hazards related to suffocation (see section 4.1) depending on the nature of the interaction and the environment of which the infant is in contact or within close proximity.

Video of infants interacting in products may be helpful to identify some hazards, but a significant amount of information related to kinematics (body position) and movement is missing if video is the only assessment available to understand infant/product interactions. Thus, we conducted an *in vivo* biomechanics study on healthy infants to understand how their bodies are positioned, how they are moving, and what muscles they are using while positioned in seated products.

Our lab has previously used gold standard experimental biomechanics techniques adapted for an infant population to study body position, movement, and/or muscle activity in different commercial infant products (Siddicky et al., 2019, 2020), on inclined crib mattress surfaces (Wang et al., 2020), within inclined sleep products (Wang et al., 2021), within a hip dysplasia harness and commercial baby carriers (Siddicky et al., 2023), and during rolling on flat surfaces (Siegel et al., 2022) and in inclined mechanical environments (Siegel et al., 2023). Our methodology related to infant biomechanics has been anonymously reviewed by our peers and accepted for publication in several different peer-reviewed journals and at professional academic conferences as peer-reviewed abstracts. We will use some of the same techniques developed and published in our previous work to understand body position, movement, and muscle activity within the seated products.

The purpose of this section is to quantify kinematics, movement, and muscle activity of infants within seated products, and to interpret that data in the context of the broader medical and biomechanical literature to understand if the design of seated products increases the risk for positional asphyxiation.

## 8.2 *In vivo* Human Subjects Testing Methods

### 8.2.1 Human Subjects Testing Logistics

We selected one product from each category for the human subjects testing based off of the IDs, product characterization, and mechanical testing, where one product was chosen for each product category (**Figure 42**). S06 was chosen for the infant carrier category because it failed the concavity test, meaning that mouth/nose contact with the product was likely. Product S06 also exhibited the worst airflow measurements in the prone position out of all infant carriers tested. In addition, this infant carrier was also the same infant carrier used for S14 (convertible stroller) in the strollers category, so we were able to test two different products with the selection of S06 as our infant carrier. Products S12 (bouncer) and S21 (swing) both feature similarly shaped plush pillows, so in order to test more features across all products, we only included one of these products and chose S12. Product S12 also had higher airflow resistance measurements so it was chosen for the bouncer category. S12 also had the highest airflow resistance measurements for all bouncers in the first contact supine condition. For the stroller category we chose S16 as it was a common stroller type and low-cost. In addition, S16 had one of the highest measurements for airflow resistance in both the supine and prone positions between all strollers. S17 was chosen for the rocker category due to the high number of incidents that had been reported in this product and because of the low-cost to purchase the product (increasing accessibility). For the swings, S24 was chosen because we wanted to test a product featuring a small pillow. This product in particular had the highest material displacement (indicating this product may conform more to an infant) and the highest airflow measurement in the supine position for the swings. S28 was chosen for the infant floor seats because we wanted to pick a product that varied more from the pillows we previously tested (similar products to pillows S25 and S29). In addition, S28 had the highest airflow measurement in the supine position for all infant floor seats. We note that airflow was used to help guide our decisions, since the lack of an airflow recommendation was not determined until a later date.





**Figure 42.** Products selected for the human subjects testing.

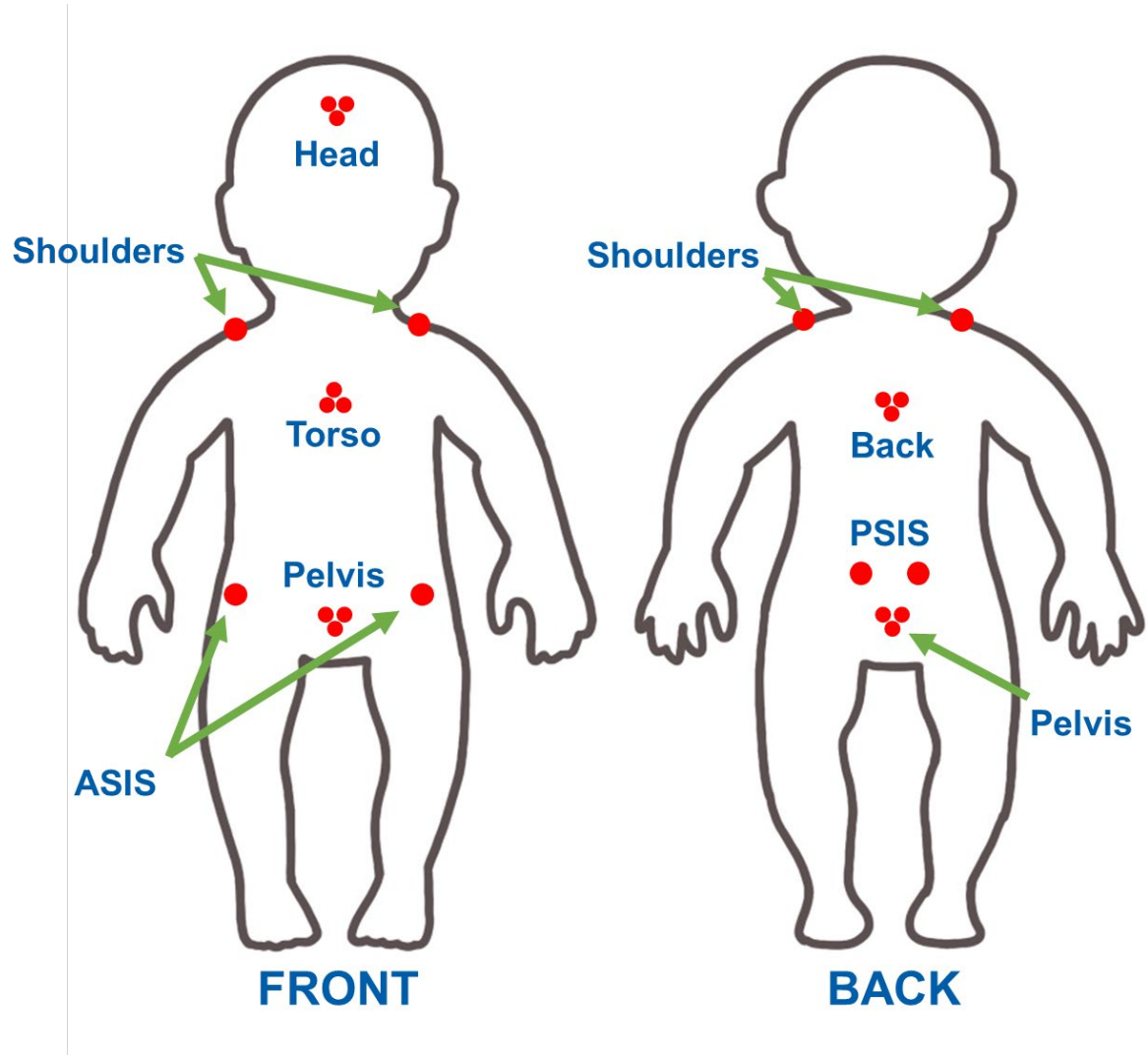
### 8.2.2 Human Subjects Data Collection

We performed a two-sample *a priori* power analysis based on normalized mean electromyography data from a previously published study on healthy infants (Siddicky et al. 2019), and determined that  $n=9$  participants per test condition would be sufficient to produce significant results ( $1-\beta = 0.8$ ;  $\alpha = 0.05$ ). Therefore, we enrolled infants until this minimum threshold of  $n=9$  per testing condition was fulfilled.

We submitted the study protocol to the Boise State University Institutional Review Board, and we received approval to carry out the study in 2021 (126-MED21-024), with renewal approval granted in 2022. We advertised for caregivers of participants via community fliers, the Boise State University campus communications, and through social and local media. Healthy infants born full-term ( $>37$  weeks gestation) without a history of orthopaedic or neurological conditions, and without a diagnosed developmental delay were eligible for the study. After a screening phone call, caregivers brought infants into the Boise Applied Biomechanics of Infants (BABI) Lab and obtained parental permission for their infant to participate in the two-hour study. Caregivers were given a \$75 gift card when they left the BABI Lab.

We collected demographic and anthropometric data, including age, sex, gestational age at birth, race, ethnicity, height, weight, and head circumference. Caregivers of infants completed the age-appropriate Ages and Stages Questionnaire to evaluate gross and fine motor development (Squires and Bricker, 2009).

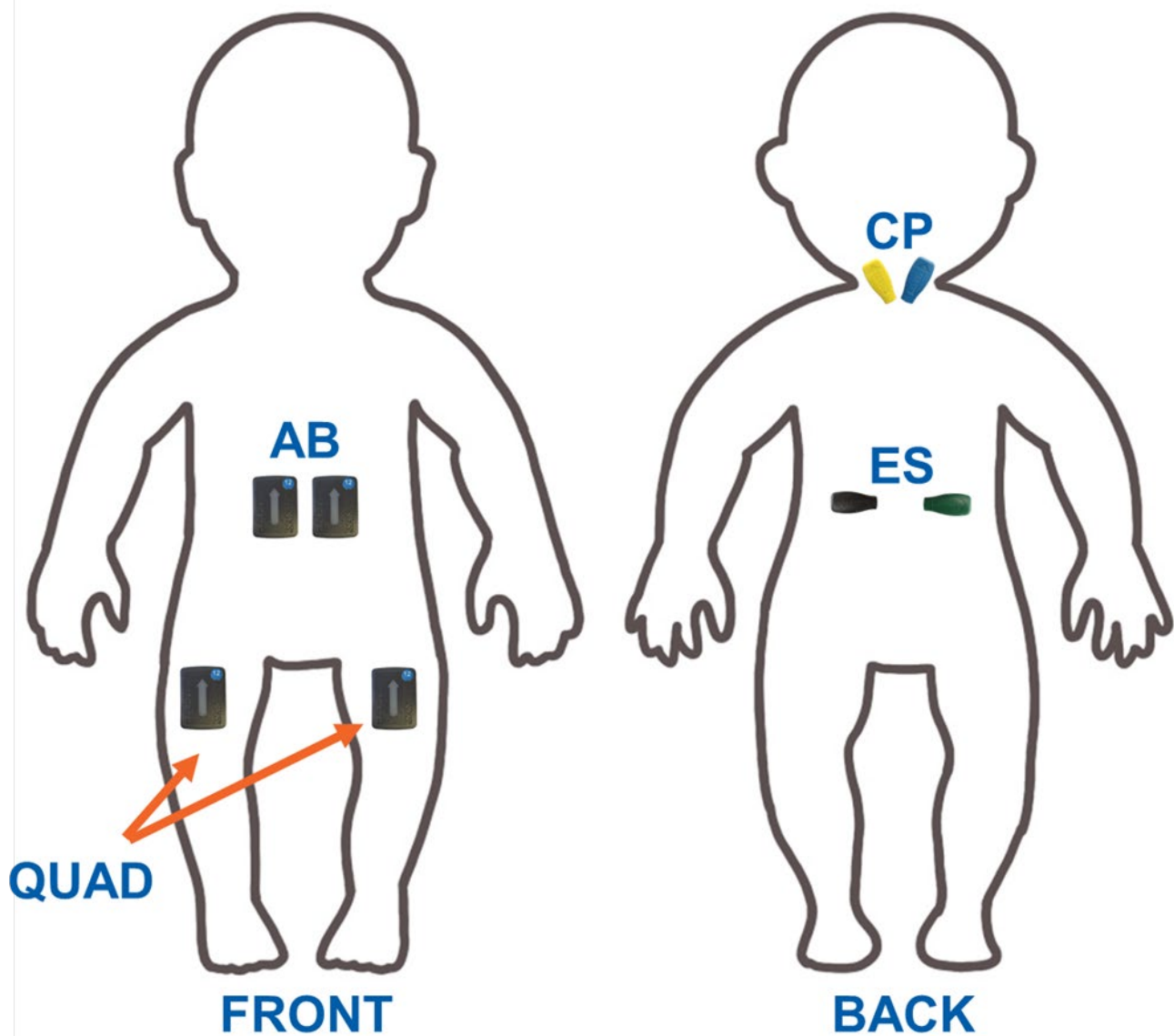
An eight-camera marker-based motion capture system (Qualisys, Göteborg, Sweden; 100 Hz, Arqus A9 cameras,  $<0.5$  mm accuracy) tracked infant kinematics using custom 3-marker rigid body clusters with 6.5 mm retro-reflective markers and 9 mm single retro-reflective markers. The rigid body clusters were placed on the front of the head, front and back of the torso, as well as the front and back of the pelvis (diaper). Single markers were placed on both shoulders, anterior superior iliac spine (ASIS), and posterior superior iliac spine (PSIS) as shown in **Figure 43**. This marker set was chosen to allow the data analysis to focus on sagittal plane head-neck, torso, and trunk-pelvis kinematics, while limiting the overall number of markers for infant comfort and post-processing optimization. Other markers were included in the experimental design (shoulders, elbows, hands, chin, and feet) but were not used in the analysis presented as part of this report.



**Figure 43.** Retro-reflective marker placement on infants. ASIS: anterior superior iliac spine; PSIS: posterior superior iliac spine.

Surface electromyography (EMG) electrodes (Delsys, Natick, MA; 2000 Hz; Trigno Avanti and Trigno Quattro Sensors) recorded bilateral muscle activity from the erector spinae (ES), cervical paraspinals (CP), abdominal muscles (AB), and the quadriceps (QUAD) (**Figure 44**). These muscle groups were chosen because the cervical paraspinals, abdominals, and erector spinae muscle groups are known to influence spinal flexion and extension (Goldman et al., 1987; Wang et al., 2020, 2021), and the quadriceps muscles are active when infants use their feet to push against surfaces. Each sensor was wrapped in flexible self-adhesive bandage to ensure placement throughout testing. A pulse oximeter with a toe sensor was used to monitor the infant's oxygen saturation ( $SpO_2$ ) levels to ensure safety (Medtronic Nellcor Portable  $SpO_2$  Patient Monitoring System (PM10N), Minneapolis, MN; 1Hz). Infants

were first placed on a firm and flat playmat in a supine position for 3 minutes and then in a prone position for an additional 3 minutes. The six products were then tested in a randomized order where supine was tested first and then prone, if applicable, each for 3 minutes. If an infant was upset, their SpO<sub>2</sub> levels dropped below 90% for a period of greater than 10 seconds (Hunt et al., 1999), or they were at risk of falling out of the product, the trial was ended.



**Figure 44.** Electromyography (EMG) sensor placement on infants. AB: abdominals; QUAD: quadriceps; CP: cervical paraspinal; ES: erector spinae.

### 8.2.3 Human Subjects Data Analysis

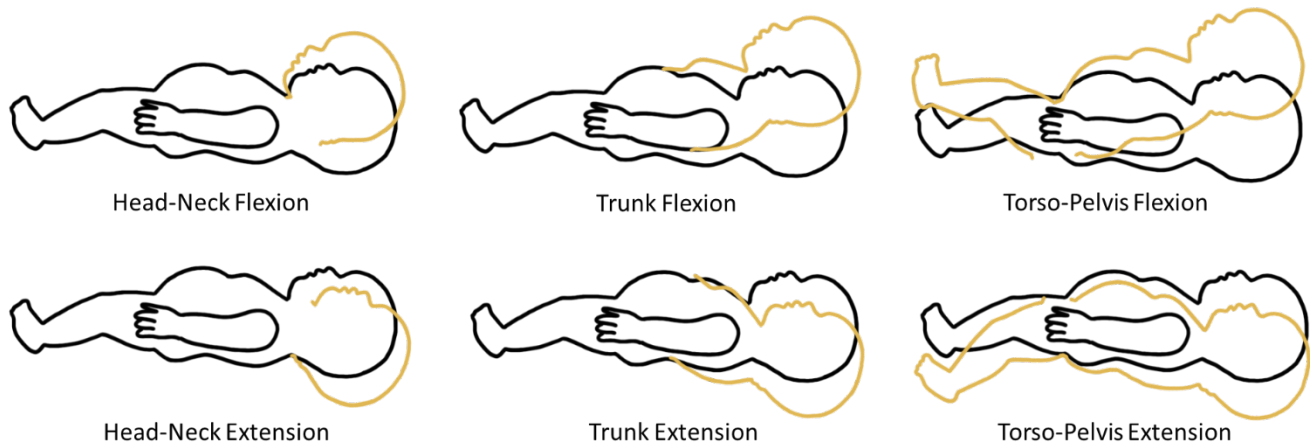
The EMG data was extracted and truncated to include only 60 seconds of data from each of the conditions. For each infant, the playmat condition was used to normalize the data for the corresponding positioning (supine to prone). This condition was used for normalization because maximal voluntary isometric contractions, which are usually used to normalize EMG data in children or adults, are impossible to obtain in an infant population, and researchers have previously used this method to present EMG data (Siddicky et al., 2020, 2021; Wang et al., 2020, 2021). Using MATLAB (Mathworks, Natick, MA), raw EMG waveforms were assessed with a power spectral analysis to remove corrupted or missing data. To reduce contamination from movement artifacts, electrocardiogram signals, and high frequency noise, the raw EMG waveforms were filtered using a band-pass 4th order Butterworth filter between 35-500 Hz. The EMG waveforms were also notch-filtered at 60 Hz using a 4th order Butterworth filter to eliminate interference from nearby electronic sources. The EMG waveforms were then full-wave rectified, demeaned, and subjected to a low-pass 4th order Butterworth filter (cutoff 50 Hz) to obtain the EMG envelope (Siddicky et al., 2020, 2021; Wang et al., 2020, 2021). This filtering process was completed for each testing condition. We used the interquartile range (IQR) method to remove sporadic errors (Thamsuwan and Johnson, 2022) before the data was normalized to the playmat condition. The mean EMG value was taken for each testing condition and the data was represented as a percentage of the playmat condition, where the playmat is always 100%. Any values above 100% represent muscle activation higher than the playmat condition, and any values less than 100% represent muscle activation lower than the playmat.

The EMG data analysis methodology was repeated for a supine quiet lying position, defined as a 5 second time interval where infants were not moving substantially. We isolated this quiet lying time period to better understand how an infant may be positioned during sleep. Paired t-tests were used to compare each product to the playmat condition for all muscle groups ( $p < 0.05$ ). As an additional statistical comparison (though we expect this comparison to be underpowered since the study was not designed to evaluate two age groups), we organized data into young ( $< 4$  months) and old ( $\geq 4$  months) age groups, and we used unpaired t-tests to determine significance differences between age groups ( $p < 0.05$ ).

The motion capture data was analyzed via a custom MATLAB code to determine the head-neck flexion, torso-pelvis flexion, and torso flexion in the supine position, and torso extension and torso-pelvis extension in the prone position (**Figure 45**). To calculate the head-neck and torso-pelvis flexion



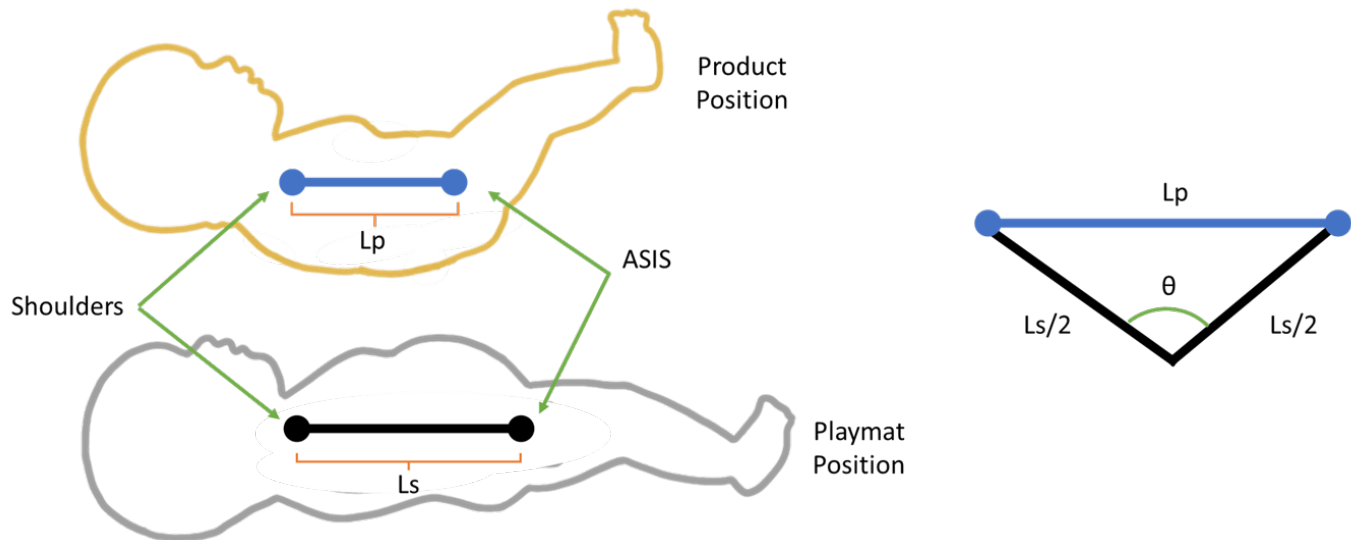
and extension angles, the angular orientation between adjacent body segments was calculated by using the marker clusters on each body segment to define unit vector matrices forming the local coordinate systems. All angles were normalized to the playmat condition to account for each infant's anatomical differences in a natural flat surface lying position.



**Figure 45.** Schematic explaining the sagittal plane kinematic variables we calculated from the motion capture data.

The head-neck flexion angular profiles were used in conjunction with a custom peak finding algorithm to calculate the number of times infants flexed their head during each trial. The peak-finding algorithm swept through the angular profile data and isolated points in time where the flexion angle value changed by  $10^\circ$  or more and  $30^\circ$  or more, and the percent time infants spent with neck flexion  $>30^\circ$  and  $>45^\circ$  during the testing. Note that these are not absolute values, but rather *changes* of those predefined magnitudes. The number of peaks is indicative of postural adjustments when infants performed a significant movement in the sagittal plane, while the percent time spent in head-neck flexion represents how frequently infants were in significant head-neck flexion.

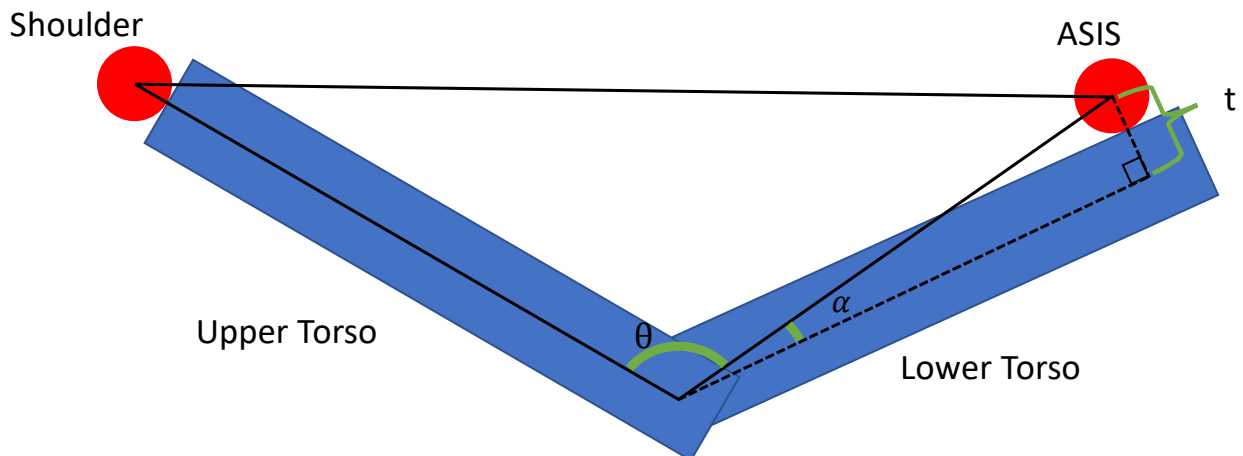
The torso flexion and extension values were calculated by determining the distance between the shoulder and the ASIS (supine) or PSIS (prone) markers in each condition. Using the playmat as our normalized position, the law of cosines was used to determine the angle (**Figure 46**).



**Figure 46.** Schematic showing how the torso flexion and extension values were calculated using the motion capture data.  $L_s$  is the length of the trunk during supine lying, and  $L_p$  is the length of the trunk during flexion.

An adjustment angle was required to account for the ASIS marker placement and each infant's anatomy. This adjustment angle was based on the pelvis thickness and the length of the torso, making the adjustment angle a constant for each baby (**Figure 47**). This adjustment was needed to account for the ASIS and PSIS markers being some distance anterior and posterior to the frontal plane of the infant, meaning the center of rotation was offset without this adjustment.





**Figure 47.** Schematic showing how adjustment angles were calculated to account for the offset between the frontal plane and the location of the retro-reflective markers. First, we used the Law of Cosines to find  $\theta$ . The variable  $t$  is the distance between the ASIS and PSIS markers, representing the thickness of the infant's pelvis. The length of the lower torso and the upper torso equals the total torso distance from the playmat condition. Finally, we calculated  $\alpha$  for each infant, and used this as the adjustment angle for all torso flexion and extension calculations in all conditions.

We performed a sensitivity analysis on the measurements used in the Law of Cosines angle calculations used to calculate trunk flexion. The sensitivity of our motion capture camera system when calibrated is approximately  $\leq 0.5$  mm which may allow for an error of up to  $8.1^\circ$  when calculating the trunk angles. However, since all trunk calculations are normalized to the flat surface condition, this systematic error is accounted for because we report only relative angles.

The motion capture analysis methodology above was repeated for a supine quiet lying position, defined as a data point where infants were in the intended position with no head rotation, and we used this position as a representation of a sleeping position. Paired t-tests were used to compare each condition to the playmat condition for all kinematic variables (head-neck flexion, trunk flexion, torso-pelvis flexion, head-neck movement) ( $p < 0.05$ ) for all infants. Similar to the EMG data, we organized motion capture into young ( $< 4$  months) and old ( $\geq 4$  months) age groups, and statistically compared the kinematic variables using unpaired t-tests ( $p < 0.05$ ), expecting this comparison to be underpowered.

The concave design of the products obstructed the view of our motion capture camera system to the anterior retro-reflective markers on the head during prone placement, thus we were unable to measure head-neck kinematics during prone trials. Instead, we reviewed video and calculated the amount of time infants spent with their face in contact with the product over each prone trial. This data is presented as a percentage of total time that infants' faces were in contact with the flat surface or seated product.

### 8.3 *In vivo* Human Subjects Testing Results

#### 8.3.1 Overall Results

We enrolled and tested 13 infants in the study in order to fulfill the n=9 per condition completion goal. Of these 13 infants, none were excluded for low scores on the fine or gross motor development sections of the Ages and Stages Questionnaire. The demographic information from the infants included in the study are presented as **Table 16**.

**Table 16.** Demographic data from the infants tested in the human subjects study.

ALL AGES									
Participant Details				Participant Measurements at Testing				Ages & Stages	
Gestational Age (weeks)	Race	Ethnicity	Sex	Age (months)	Weight (kg)	Height (cm)	Head Circumference (cm)	Gross Motor	Fine Motor
39.1	White	Caucasian	Male	5.7	7.4	63.0	42.5	50	55
40.6	White	Caucasian	Female	3.6	6.3	60.0	39.0	60	60
38.0	White	Caucasian	Male	7.3	8.4	66.0	46.0	40	50
38.0	White	Caucasian	Female	3.2	6.0	62.5	41.0	60	60
37.7	White/Hispanic	Caucasian	Male	5.2	8.7	65.0	42.0	30	40
40.9	White	Caucasian	Female	5.6	6.5	58.5	43.5	45	60
38.0	White	Caucasian	Male	5.1	6.6	64.0	40.0	25	45
39.0	White	Caucasian	Female	4.5	6.5	61.0	42.0	50	40
39.0	White	Caucasian	Male	3.0	6.8	58.0	41.0	35	30
41.6	White	Caucasian	Male	3.5	7.1	66.0	43.0	60	35
37.4	White/Hispanic	Caucasian	Female	2.6	5.9	54.0	40.0	50	50
37.0	White	Caucasian	Female	3.7	6.4	58.0	40.5	60	40
39.0	White	Caucasian	Male	2.1	6.1	56.0	40.0	55	55

All infants completed the supine and prone playmat conditions. The numbers of infants who completed every other condition are listed in **Table 17**. **Figures 48 to 54** are examples of infants during testing in each test condition.

**Table 17.** Numbers of infants who completed each testing condition.

Playmat		Car Seat		Bouncer		Stroller		Rocker		Swing		Lounger	
Supine	Prone	Supine	Prone	Supine	Prone	Supine	Prone	Supine	Prone	Supine	Prone	Supine	Prone
13	13	13	12	13	13	12		13	13	13	9	13	



Figure 48. Experimental photos of infants in the playmat condition.





Figure 49. Experimental photos of infants in the infant carrier condition.



Figure 50. Experimental photos of infants in the bouncer condition.





**Figure 51.** Experimental photos of infants in the stroller condition.



Figure 52. Experimental photos of infants in the rocker condition.





**Figure 53.** Experimental photos of infants in the swing condition.



**Figure 54.** Experimental photos of infants in the infant floor seat condition.

The infant floor seat was excluded from all motion capture analysis because the product configuration reduced marker visibility on the torso and pelvis. The head-neck flexion was the only measurement calculated for the stroller due to reduced marker visibility on the pelvis. No infants reached concerning SpO<sub>2</sub> levels (<90% for >10 seconds) during testing, though we noted data gaps in our SpO<sub>2</sub> monitoring system due to excessive infant movement, which presented difficulties considering our trials were 60 seconds total.

We also noted some unusual events and body positions that infants obtained in several products. Some infant's faces were in constant contact with some products (**Figure 55**). The swing presented unique hazards to the infants in the prone position, where the center of gravity shift of the infants caused the swing to rotate forward (**Figure 56**). Some infant's chins were in contact with their chests during testing in some products (**Figure 57**). We noted some special circumstances where infants rolled in the products, exhibited a crawling pose while prone, and slid in the products (**Figure 58**).





**Figure 55.** Example of infants with their faces in direct contact with the playmate and products during prone positioning (Playmat, S06, S12, S17, and S24) and intended positioning (S28). Some of these infants remained in contact with the product for the entire 60 second trials.

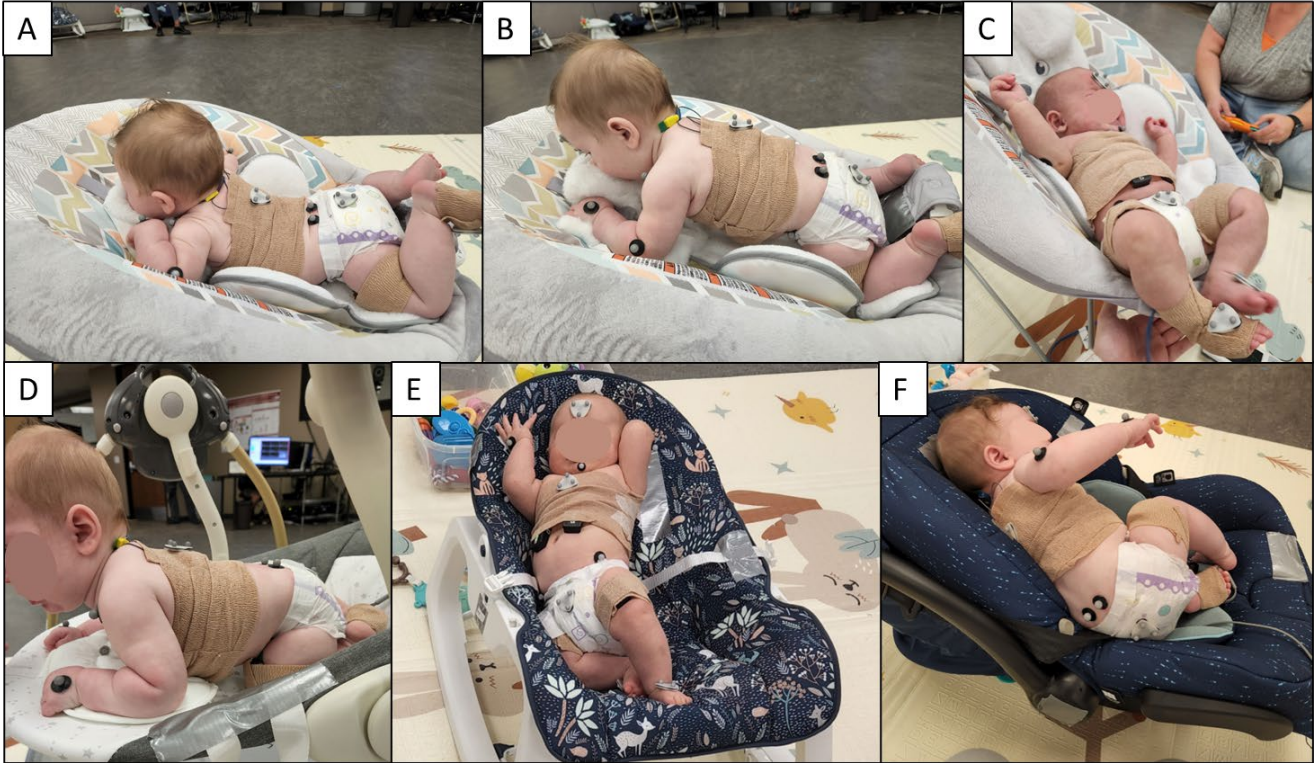


**Figure 56.** Examples of prone positioning in the swing. Some infants caused the swing to rotate forward during prone positioning due to the shift in the center of gravity.



**Figure 57.** Example of a chin-to-chest position for an infant in the intended supine position in the swing condition.



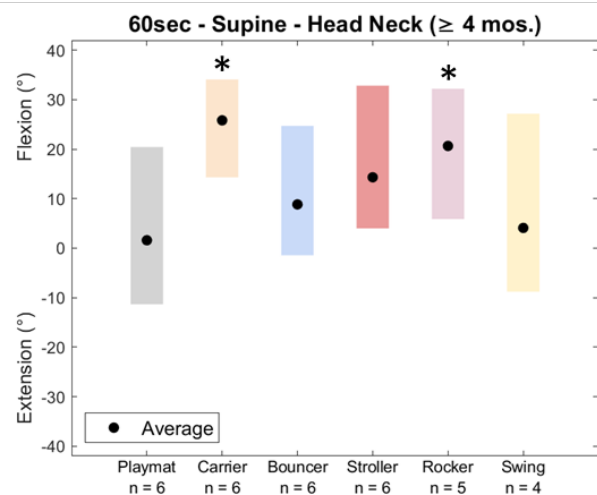
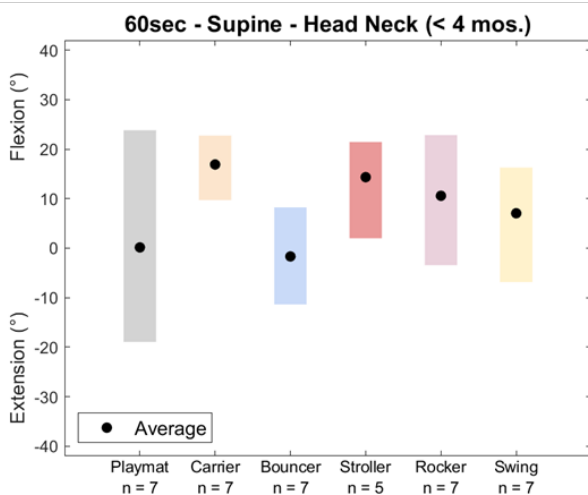
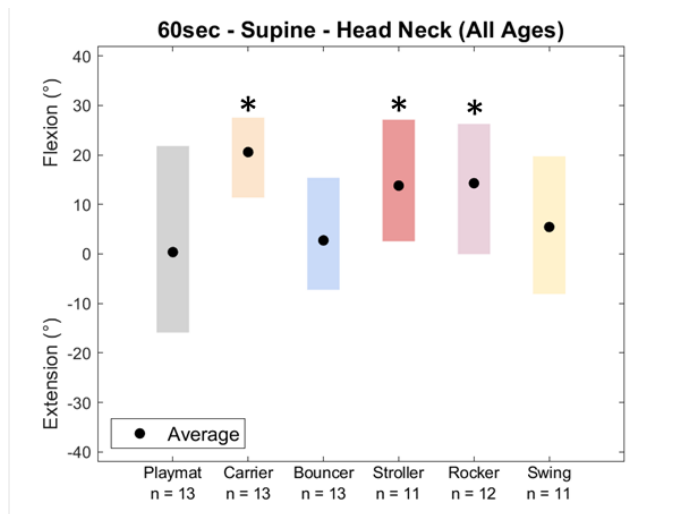


**Figure 57.** Examples of unusual circumstances we noted. (A) and (C) show sliding within the product; (B) and (D) represent infants attempting crawling maneuvers in the prone position; and (E) and (F) are examples of rolling movements during supine lying in products.

### 8.3.2 Kinematic Results

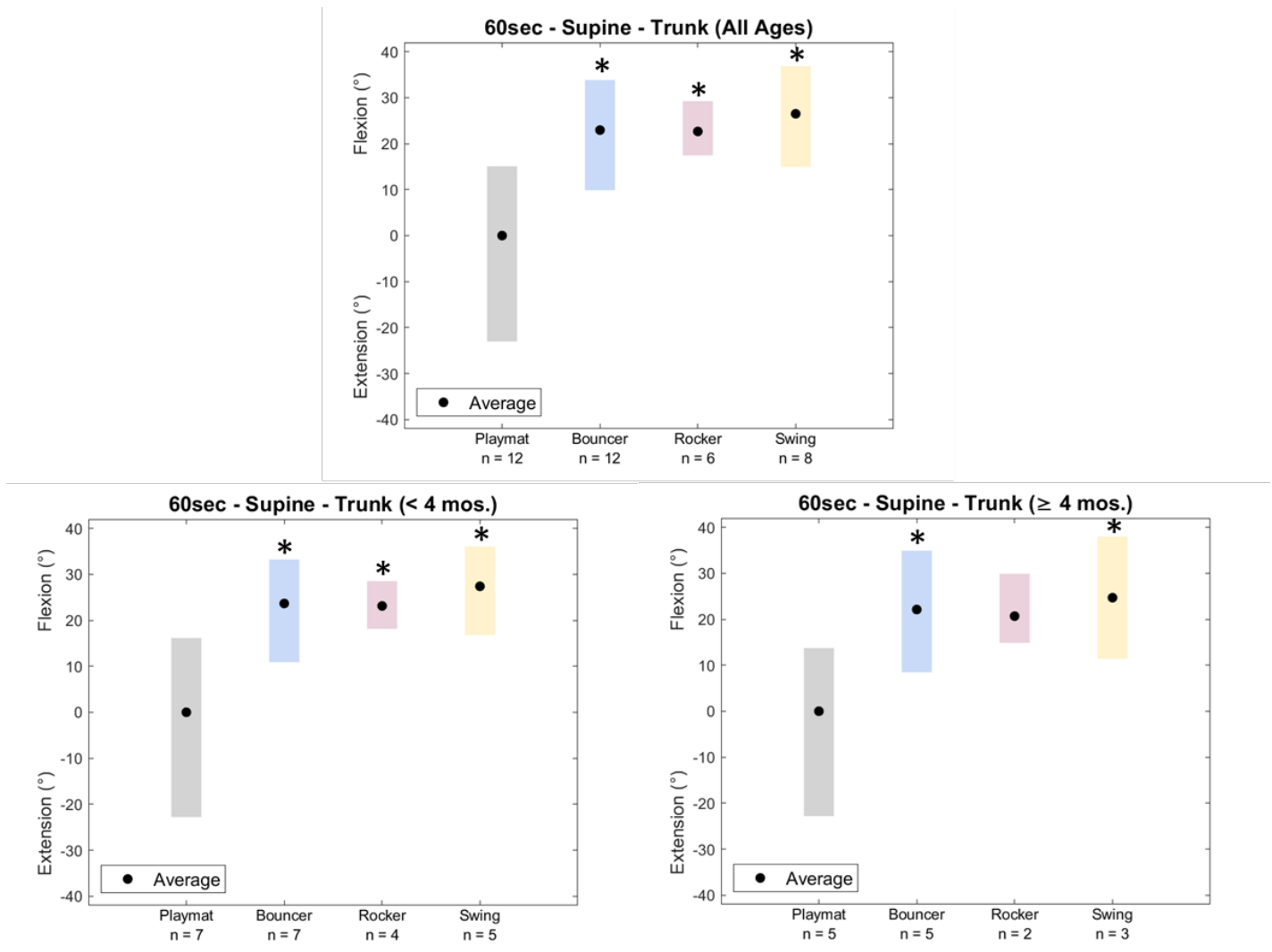
#### 8.3.2.1 Supine Lying

Head-neck angle results from the full 60 second supine lying trials are presented in **Figure 59**. Results show that the infant carrier, stroller, and rocker result in higher mean head-neck flexion angles compared to the playmat ( $p < 0.05$ ; up to  $21^\circ$  in the infant carrier condition). The infant carrier also featured the lowest head-neck excursions (the average minimum to the average maximum rotations), while the playmat featured the highest. There were no significant differences between the  $< 4$  months and  $\geq 4$  months age groups.



**Figure 58.** Supine lying head-neck angles for infants in all conditions, where the bar represents the average excursion for the infants and the black dot represents the mean, normalized to the mean of the playmat condition. Top: data for all infants; Left: data for younger infants; Right: data for older infants. \* $p < 0.05$  mean vs. playmat condition.

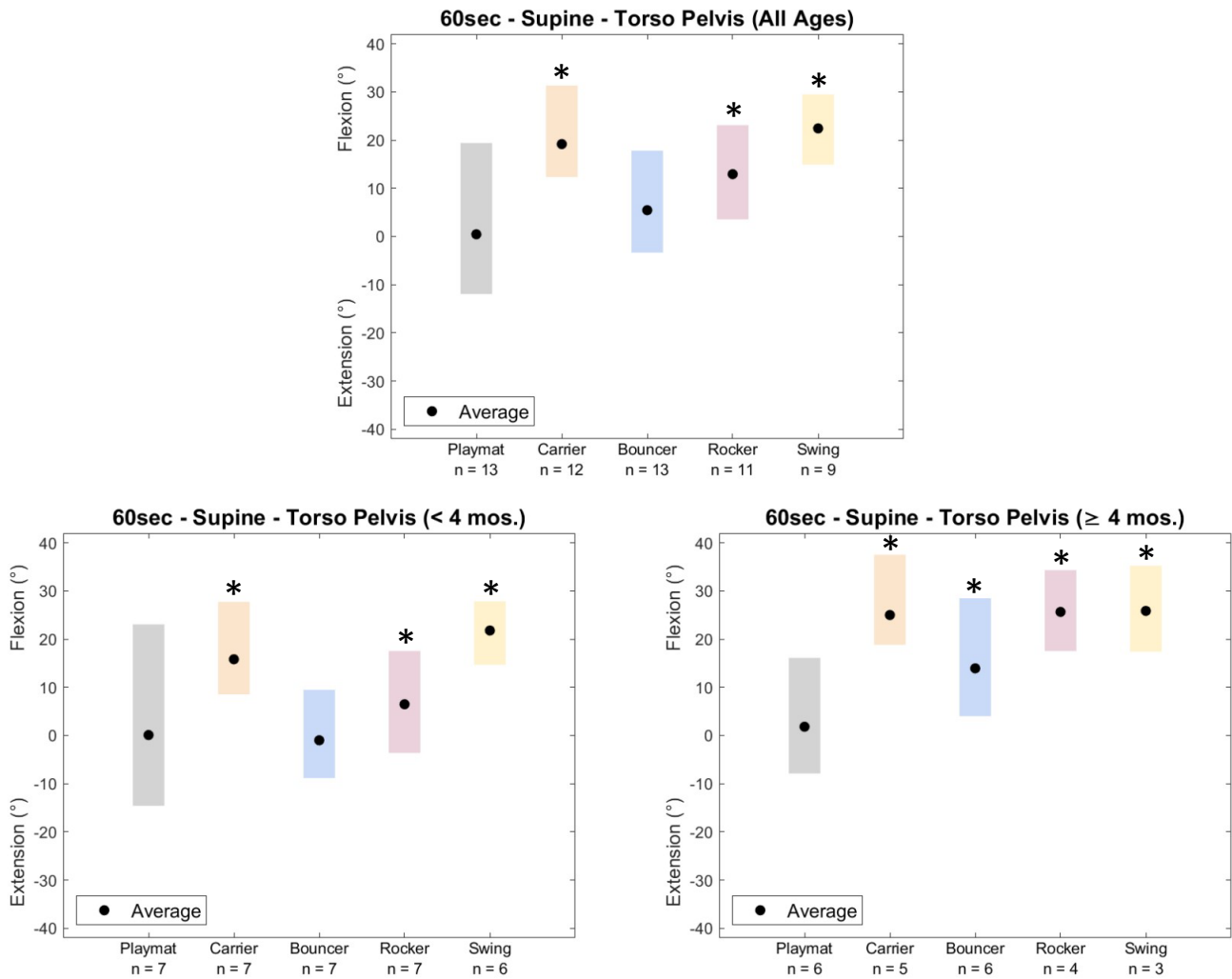
Trunk or torso flexion results during supine lying are presented as **Figure 60**. Mean trunk flexion was significantly higher for the bouncer, rocker, and swing compared to the playmat conditions – between 23° and 27° more. Excursions were lowest for the rocker condition (only 12°) and highest for the playmat condition. There were no significant differences between the < 4 months and ≥ 4 months age groups. This data most likely corresponds to how conforming and concave the product is in the longitudinal direction, where products that are more conforming and/or concave result in higher trunk flexion angles as infants’ bodies conform to the shape of the product.



**Figure 59.** Supine lying torso or trunk flexion angles for infants in all conditions, where the bar represents the average excursion for the infants and the black dot represents the mean, normalized to the mean of the playmat condition. Top: data for all infants; Left: data for younger infants; Right: data for older infants. Data from the stroller, infant floor seat, and infant carrier positions could not be used due to covered retroreflective markers. \*p<0.05 mean vs. playmat condition.

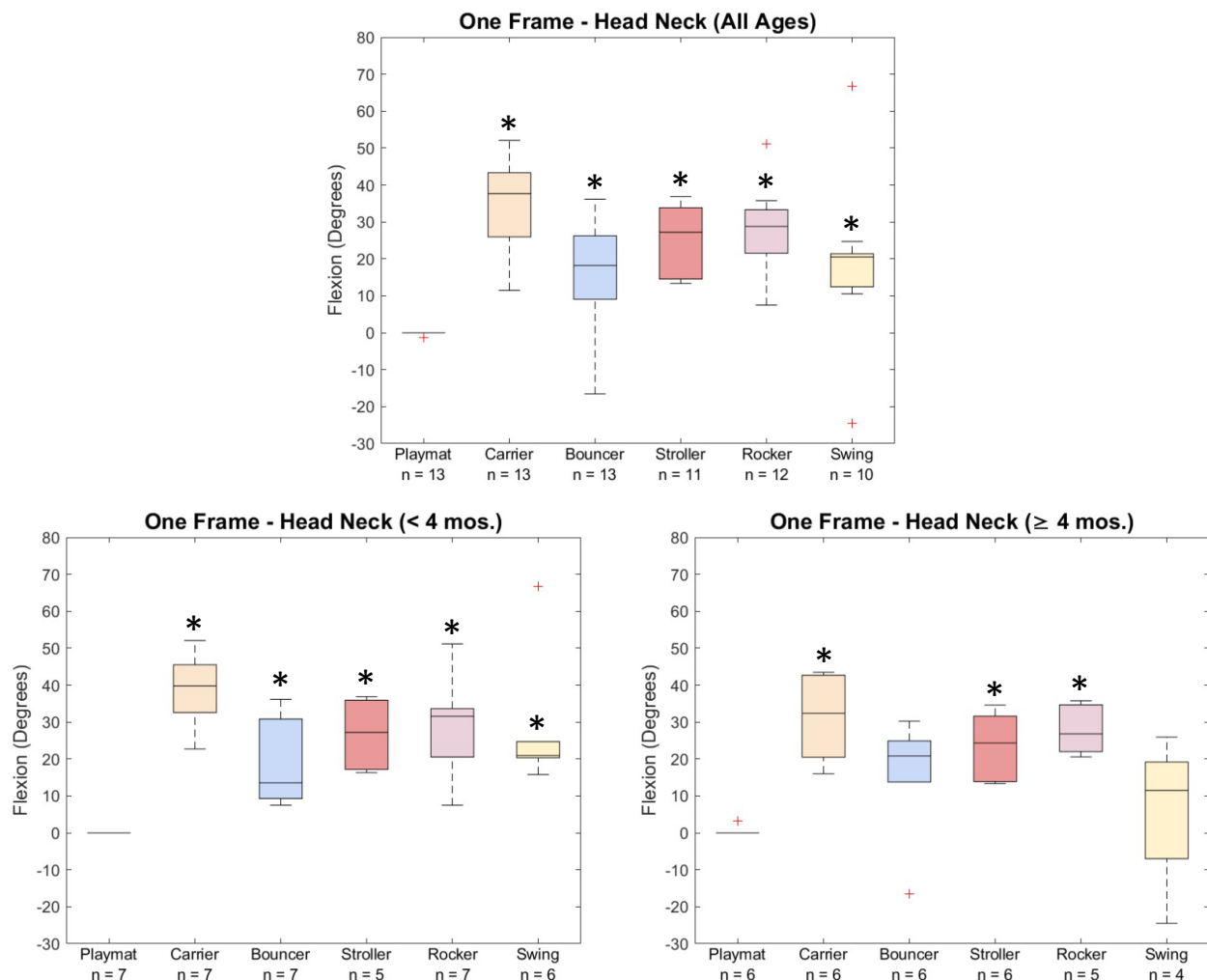


Torso-pelvis flexion results during supine lying are presented as **Figure 61**. Torso-pelvis flexion was significantly higher for the infant carrier, rocker, and swing compared to the playmat conditions – between 13° and 23° more. There were no significant differences between the < 4 months and ≥ 4 months age groups.



**Figure 68.** Supine lying torso-pelvis flexion angles for infants in all conditions, where the bar represents the average excursion for the infants and the black dot represents the mean, normalized to the mean of the playmat condition. Top: data for all infants; Left: data for younger infants; Right: data for older infants. Data from the stroller and infant floor seat positions could not be used due to covered retroreflective markers. \* $p < 0.05$  mean vs. playmat condition.

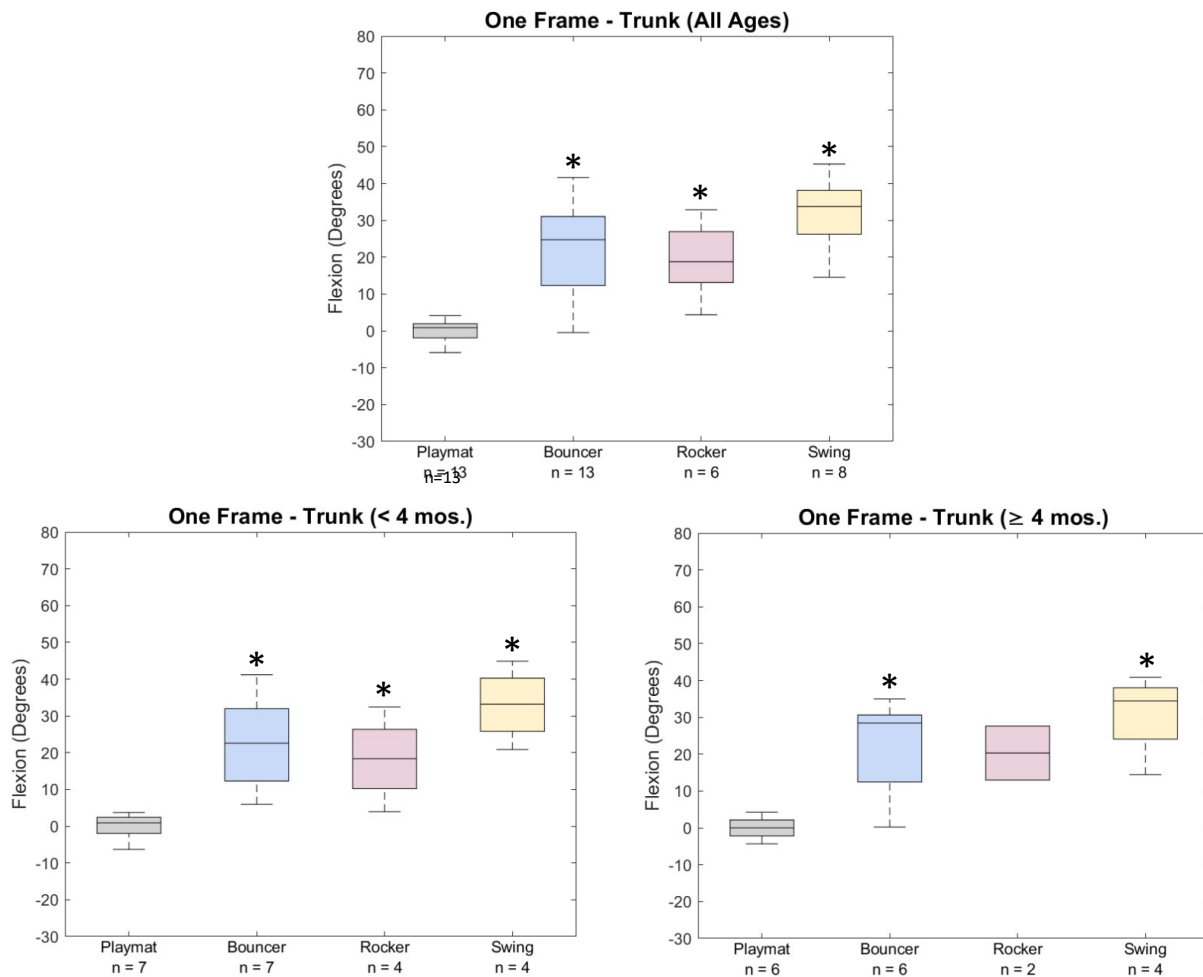
The following body position results during supine quiet lying represent a single point of data where infants were still, positioned symmetrically, and in the intended position. This data is representative of the body position an infant might experience as they fall asleep. We note, however, that muscles relax during sleep (Blumberg, 2016; Davis et al., 2004; Schwarz et al., 2012), so body position results of infants sleeping in the products would be exaggerated compared to these results when infants were still awake and alert. The data are presented as box and whisker plots, where the median is the horizontal line within the shaded box, the shaded box represents the 25<sup>th</sup> to 75<sup>th</sup> percentile, called the interquartile range, the dotted lines to the end caps represent the minimum and maximum non-outlier values, and the red plus signs represent outliers. Statistical differences between



**Figure 77.** Supine lying head-neck flexion angles for infants in all conditions in a quiet lying position, normalized to the mean in the playmat condition. Top: data for all infants; Left: data for younger infants; Right: data for older infants. Data from the infant floor seat condition could not be used due to covered retroreflective markers. \*p<0.05 median vs. playmat condition.

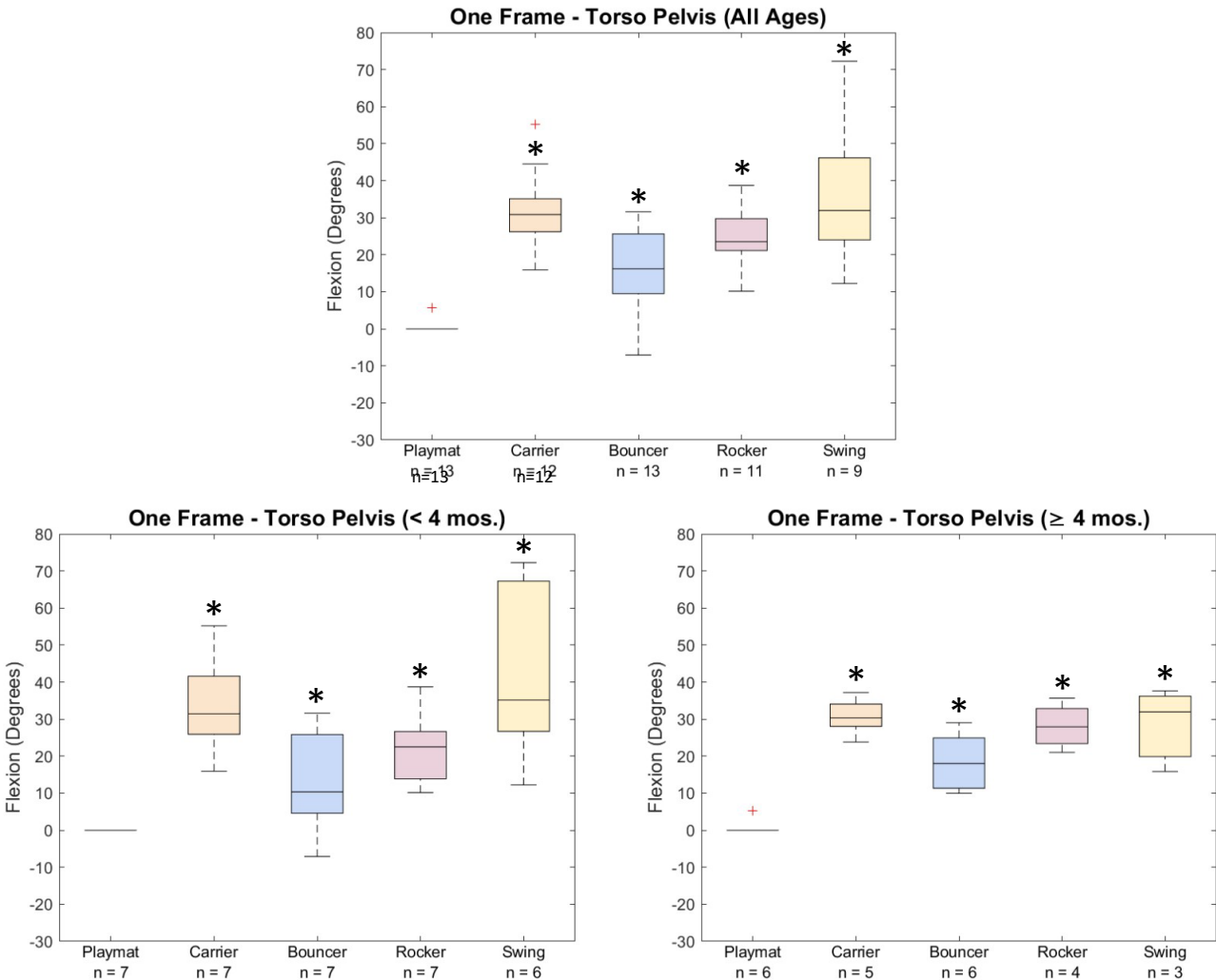
the testing conditions and the playmat condition are noted (\* $p < 0.05$ ). Head-neck flexion angles are presented as **Figure 62**. All seated products resulted in higher neck-flexion angles compared to the playmat condition, with the infant carrier showing a median of nearly 38° (mean 34°) of head-neck flexion angle during quiet lying.

Trunk or torso flexion angles are presented as **Figure 63**. The bouncer, rocker, and swing all resulted in higher trunk flexion angles compared to the playmat condition, with the swing showing a median of 34° (mean of 32°) of trunk flexion during quiet lying.



**Figure 78.** Supine lying trunk or torso flexion angles for infants in all conditions in a quiet lying position, normalized to the mean in the playmat condition. Top: data for all infants; Left: data for younger infants; Right: data for older infants. Data from the infant carrier, stroller, and infant floor seat conditions could not be used due to covered retroreflective markers. \* $p < 0.05$  median vs.

Torso-pelvis flexion angles are presented as **Figure 64**. The bouncer, rocker, and swing all resulted in higher trunk flexion angles compared to the playmat condition, with the infant carrier and swing showing over 30° of torso-pelvis flexion during quiet lying. The swing condition showed the most variability, especially for the infants < 4 months of age.



**Figure 86.** Supine lying torso-pelvis flexion angles for infants in all conditions in a quiet lying position, normalized to the mean in the playmat condition. Top: data for all infants; Left: data for younger infants; Right: data for older infants. Data from the stroller and infant floor seat conditions could not be used due to covered retroreflective markers. \*p<0.05 median vs. playmat condition.

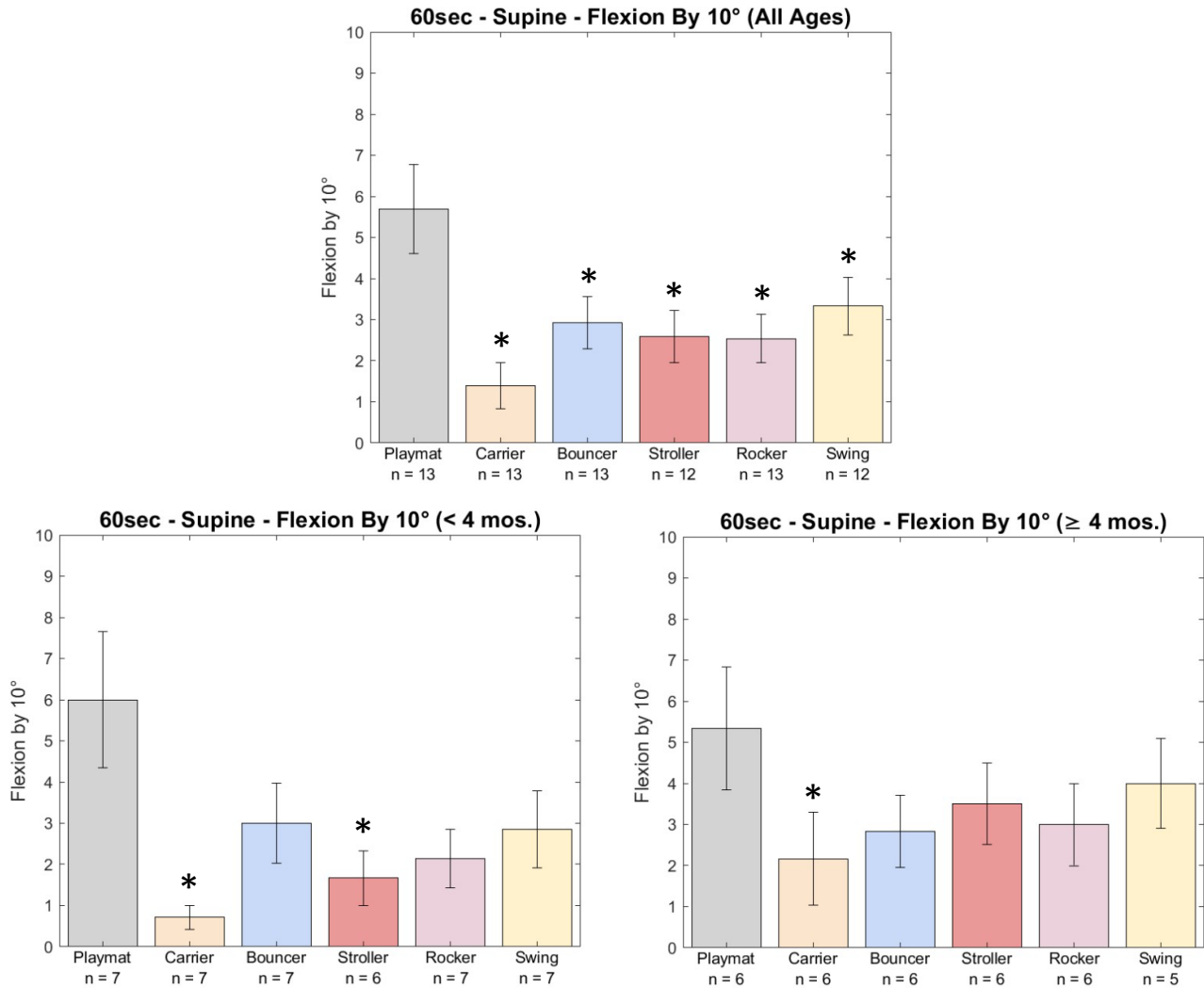
All head-neck, trunk, and torso-pelvis flexion angles from the quiet lying data is presented in

**Table 18.**

**Table 19.** Median and quartile data for the quiet lying data.

		Head Neck			Trunk			Torso Pelvis		
		All	< 4 mos.	≥ 4 mos.	All	< 4 mos.	≥ 4 mos.	All	< 4 mos.	≥ 4 mos.
Playmat	25th	0.0	0.0	0.0	-1.9	-2.0	-2.2	0.0	0.0	0.0
	Median	0.0	0.0	0.0	0.9	0.9	0.0	0.0	0.0	0.0
	75th	0.0	0.0	0.0	1.9	2.4	2.2	0.0	0.0	0.0
Carrier	25th	26.0	32.6	20.4				26.2	25.9	28.0
	Median	37.7	39.8	32.3				30.9	31.4	30.3
	75th	43.3	45.5	42.7				35.1	41.6	34.1
Bouncer	25th	9.1	9.3	13.8	12.3	12.3	12.5	9.5	4.6	11.3
	Median	18.2	13.5	20.8	24.7	22.6	28.5	16.2	10.4	18.0
	75th	26.2	30.8	24.9	31.0	32.0	30.6	25.6	25.8	24.9
Stroller	25th	14.5	17.2	13.9						
	Median	27.2	27.2	24.3						
	75th	33.8	35.9	31.6						
Rocker	25th	21.5	20.5	22.0	13.1	10.2	13.0	21.2	13.9	23.4
	Median	28.8	31.6	26.8	18.8	18.4	20.3	23.5	22.5	27.9
	75th	33.3	33.6	34.6	27.0	26.4	27.6	29.7	26.7	32.9
Swing	25th	12.4	20.3	-7.0	26.2	25.8	24.1	24.0	26.7	19.9
	Median	20.5	20.9	11.5	33.8	33.2	34.5	32.0	35.2	32.0
	75th	21.4	24.7	19.2	38.2	40.3	38.0	46.2	67.3	36.2

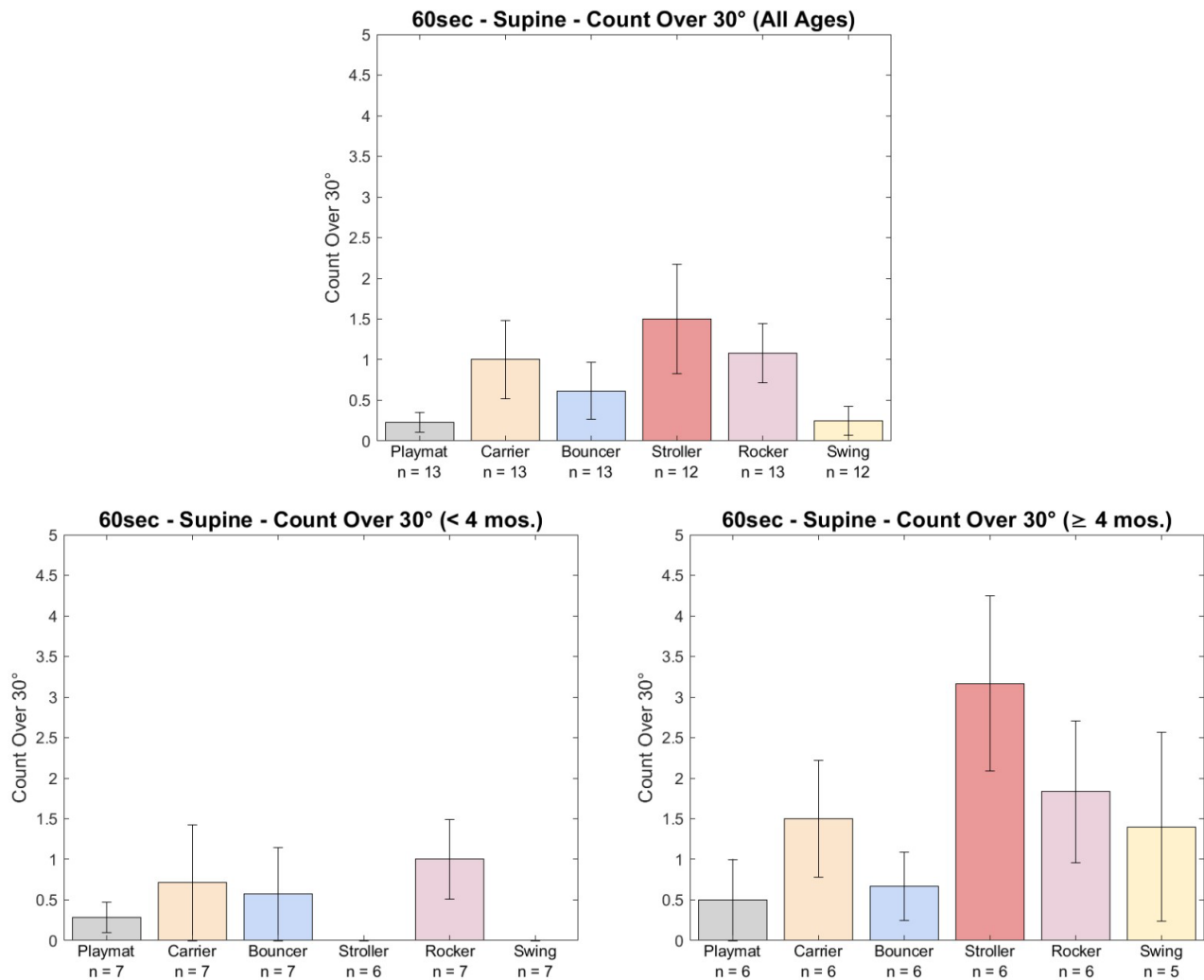
The number of times an infant reached  $>10^\circ$  of head-neck flexion movement during each trial is presented as **Figure 65**. Infants moved their head and neck significantly more in the playmat condition ( $p<0.05$ ), and the infant carrier condition resulted in the fewest movements.



**Figure 92.** Number of times infants reached a  $10^\circ$  head-neck flexion angle during each trial, presented as (top) all ages, (left) younger infants, and (right) older infants.

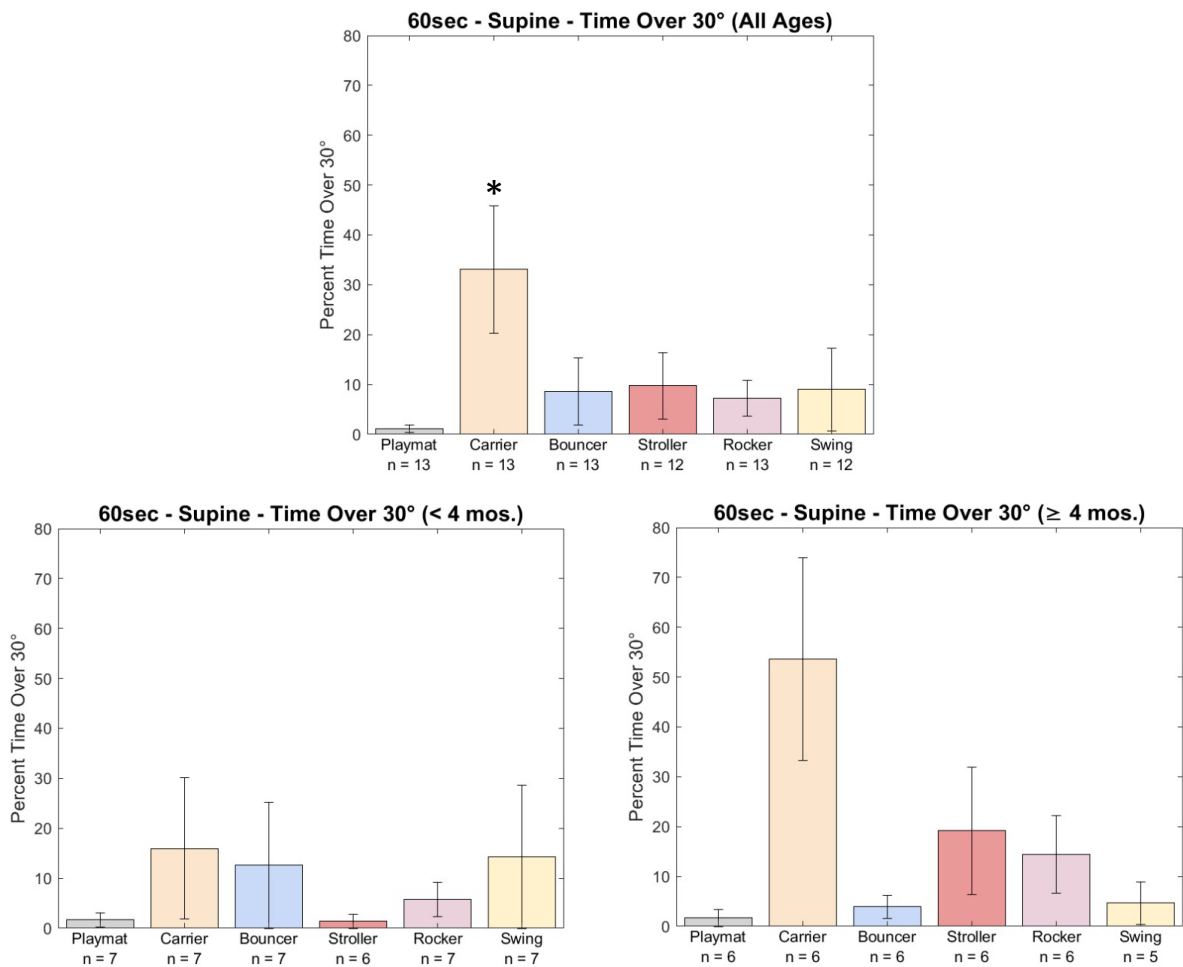


The number of times an infant reached  $>30^\circ$  of head-neck flexion movement during each trial is presented as **Figure 66**. Infants reached  $>30^\circ$  of head-neck flexion the least number of times overall in the playmat condition, and in the most in the stroller condition, though statistical significance was not reached. Older infants tended to exhibit more frequent movements than younger infants.



**Figure 93.** Number of times infants reached a  $30^\circ$  head-neck flexion angle during each trial, presented as (top) all ages, (left) younger infants, and (right) older infants.

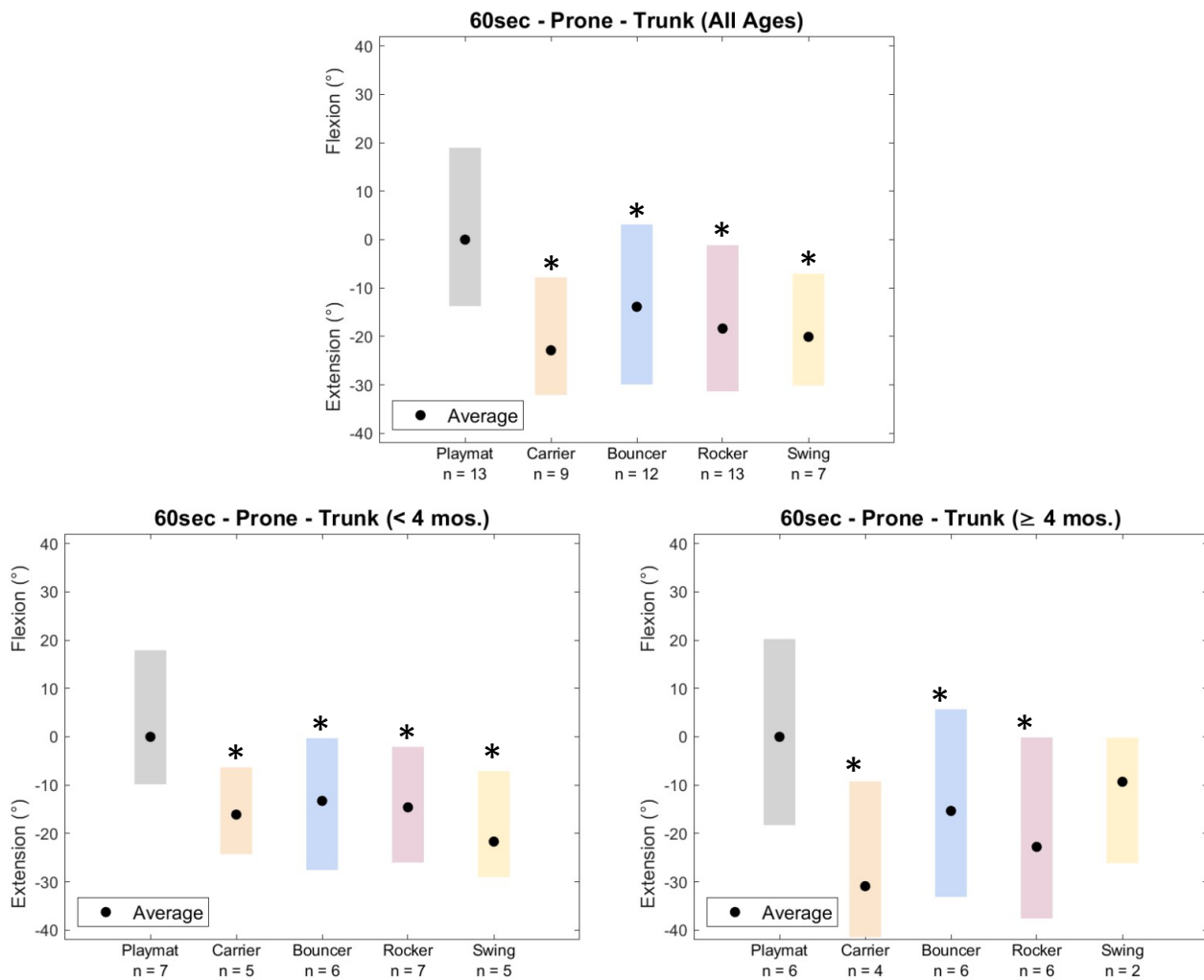
In addition to the number of movements infants made above a 30° head-neck flexion movement, we also calculate the percent time that infants spent with a head-neck flexion angle >30°, presented as **Figure 67**. Infants spent 1% of time on the playmat in head-neck flexion of >30°, and they spent the most time, over 33%, in head-neck flexion >30° in the infant carrier. In other seated products, infants spent from 7-10% of the time in head-neck flexion >30°, though these results varied between participants. In the infant carrier, six infants had 0 seconds above 30° head-neck flexion; however, three infants spent the entire 60 seconds above this threshold. Similarly, the stroller had seven infants spending 0 seconds above 30° head-neck flexion and one infant that spent 49 seconds above the 30° head-neck positioning. This indicates that the individual experience of the infants during intended positioning varies widely, where head-neck positioning is a concern for some infants and not a concern for others. Most infants did not reach a head-neck flexion of >45° during any test condition, with the exception of the swing, where one participant experienced >45° head-neck flexion for 30% of the trial.



**Figure 102.** The percentage of time that infants spent in >30° head-neck flexion angle during each trial, presented as (top) all ages, (left) younger infants, and (right) older infants.

### 8.3.2.2 Prone Lying

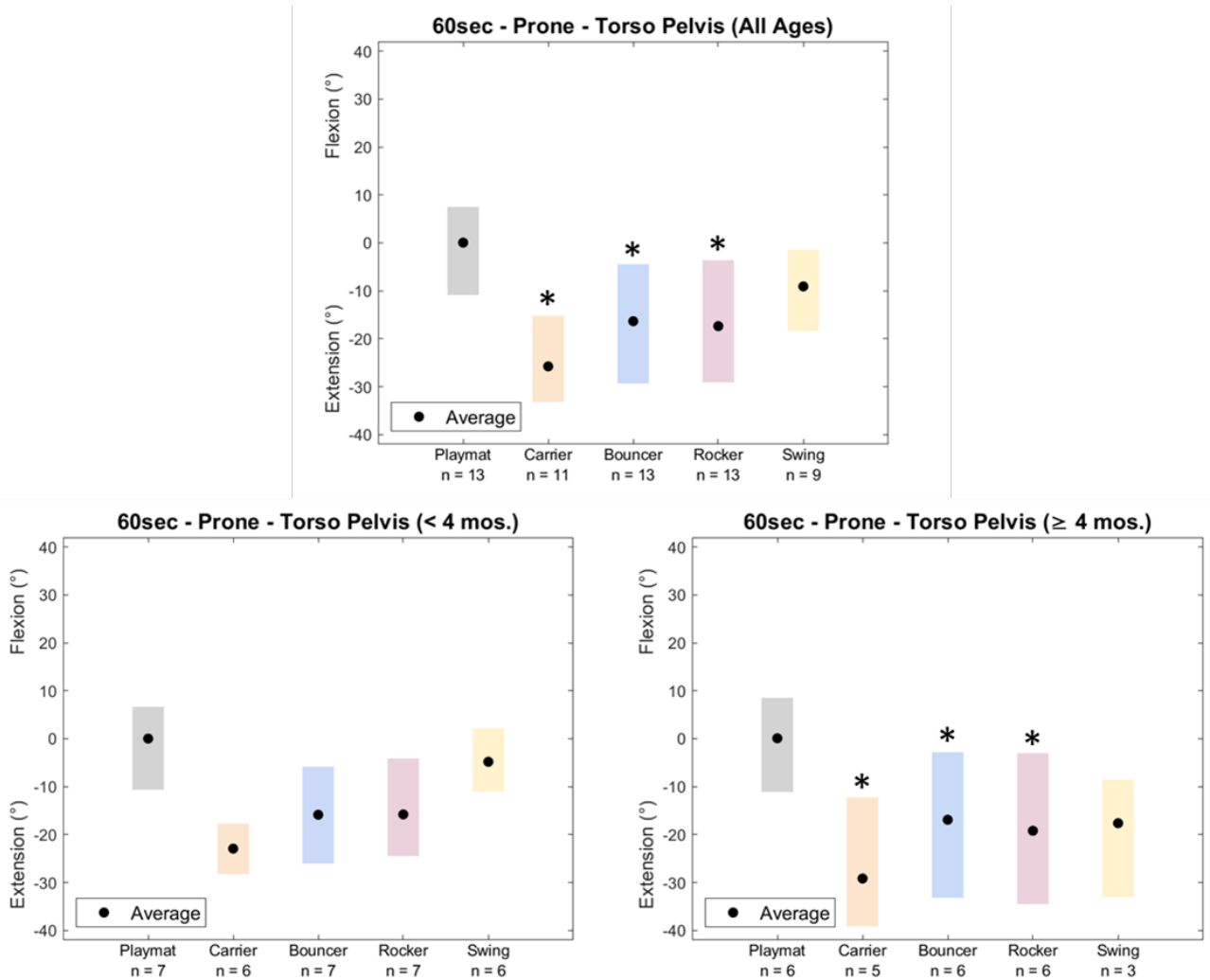
Trunk flexion results from the full 60 second supine lying trials are presented as **Figure 68**. Every seated product we tested resulted in a more extended trunk for infants compared to the prone playmat condition, with mean extension angles ranging from 14° to 23° (extension values are shown as negative numbers on the graphs). Younger infants featured smaller excursions in all products compared to older infants, and had less mean extension in most products, though there were no statistical differences between the age groups due to the small sample size in each group.



**Figure 111.** Prone lying torso or trunk flexion angles for infants in all conditions, where the bar represents the average excursion for the infants and the black dot represents the mean, normalized to the mean of the prone playmat condition. The infant floor seat and stroller were unable to be tested in the prone position. Top: data for all infants; Left: data for younger infants; Right: data for older infants.

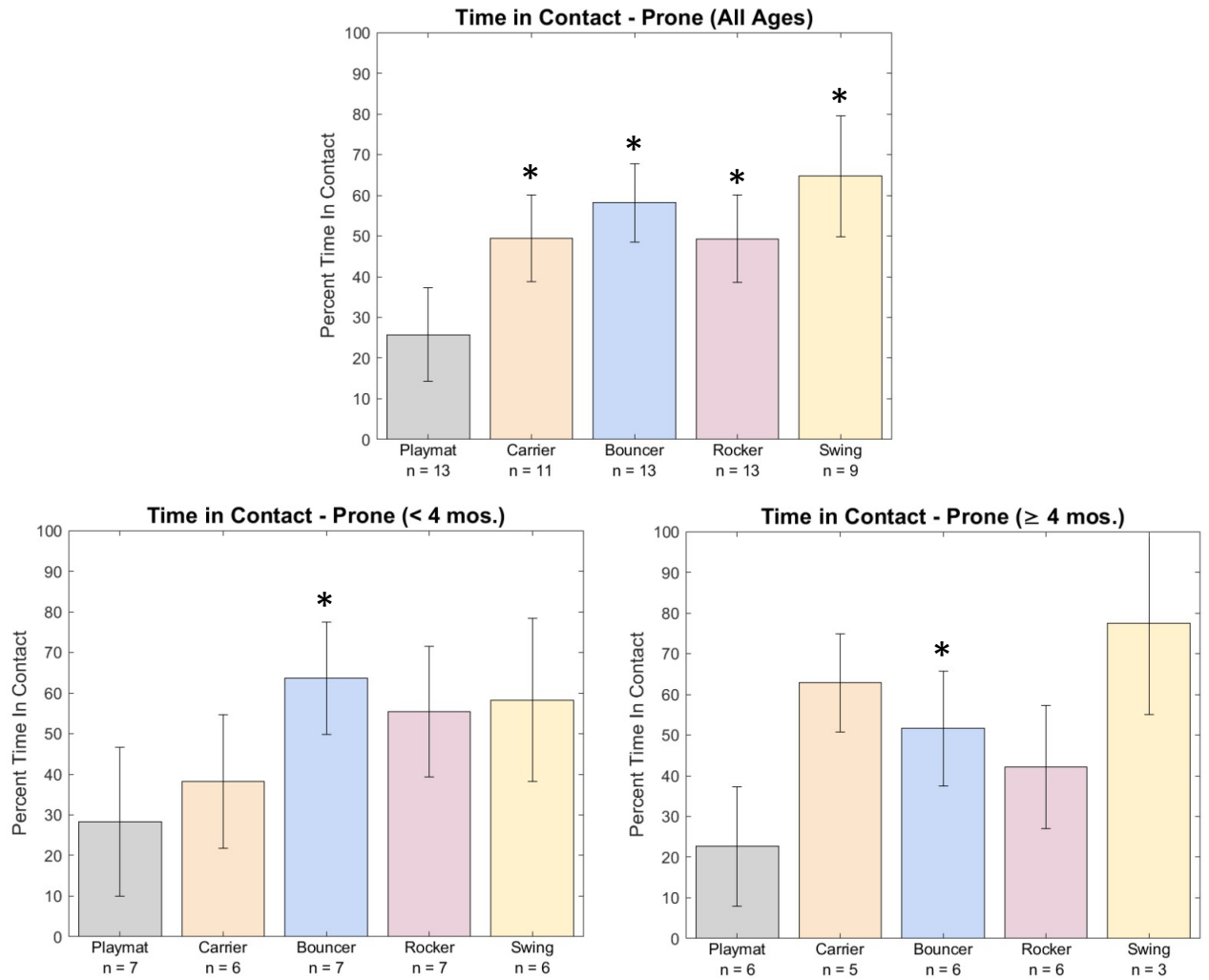
\*p<0.05 mean vs. playmat condition.

Torso-pelvis extension for infants during prone lying is presented as **Figure 69**. Infants experienced more torso-pelvis extension in the infant carrier, bouncer, and rocker, ranging from 16° to 26°. Younger infants again had less overall excursion in all products compared to the older infants, though statistical significance was not reached due to a small sample size.



**Figure 112.** Prone lying torso-pelvis flexion angles for infants in all conditions, where the bar represents the average excursion for the infants and the black dot represents the mean, normalized to the mean of the prone playmat condition. The infant floor seat and stroller were unable to be tested in the prone position. Top: data for all infants; Left: data for younger infants; Right: data for older infants. \* $p < 0.05$  mean vs. playmat condition.

In the prone position, infants' faces were in contact with the seated product more often compared to the playmat condition ( $p < 0.05$ ), with contact nearly 65% of the trial on average for the swing, 60% for the bouncer, 50% for the infant carrier, and 48% for the rocker compared to 26% for the playmat (**Figure 70**). This demonstrates a concerning hazard if an infant were to be placed prone or roll from supine to prone in one of these seated products. Not only is their face in contact with the product more often than it is on a flat surface, but the surfaces of the seated products also feature significant concavity, meaning that more head rotation and movement is required to free the mouth/nose to breathe. Furthermore, some of the products – particularly the bouncer – features a plush pillow feature, so the infant will be breathing directly into the pillow. For the bouncer, all infants experience at least some time with their mouth/nose in contact with the surface of the product. Three infants' mouth/nose regions were in contact with the product for less than 10 seconds, while five infants were in contact for over 45 seconds. For the swing, two infants had 0 seconds in contact while five infants spent the full 60 seconds in contact. Like the variation in individual experience during supine lying, this range of time spent in contact with different products during prone lying indicates that body position and movements vary between infants.



**Figure 113.** Mean ( $\pm$ standard error) time that infants' faces were in contact with the seated product in the prone condition for (Top) all infants, (Left) younger infants, and (Right) older infants. There were no differences between younger and older infants. \* $p < 0.05$  vs. playmat condition.

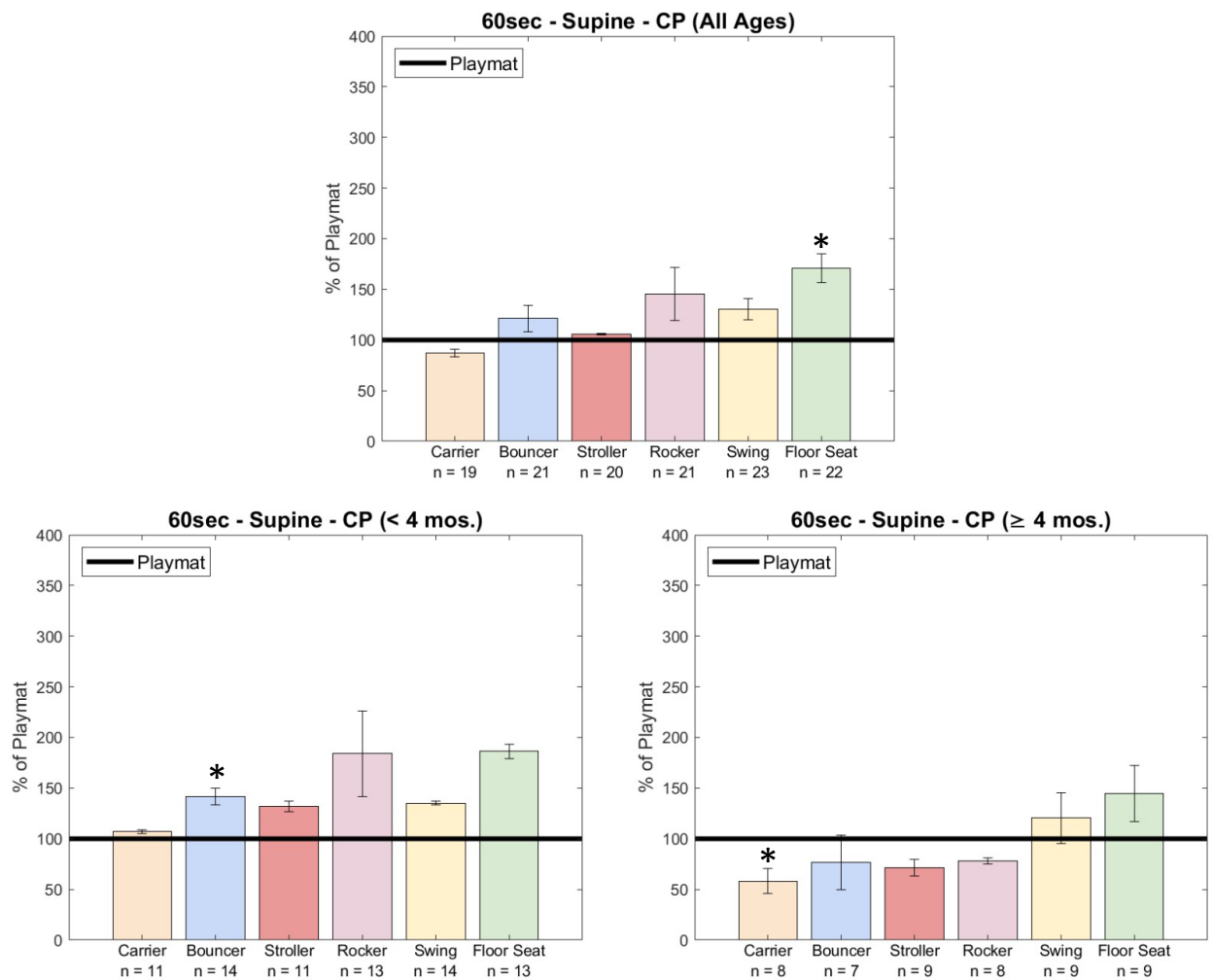


### 8.3.3 EMG Results

#### 8.3.3.1 Supine Lying

EMG results are presented along with the number of individual muscle groups that were included in the analysis below each bar. The experimental goal was for 9 infants to complete each activity, with usable bilateral EMG data. Because some data was excluded (see above), bilateral muscle activity was not available for every infant.

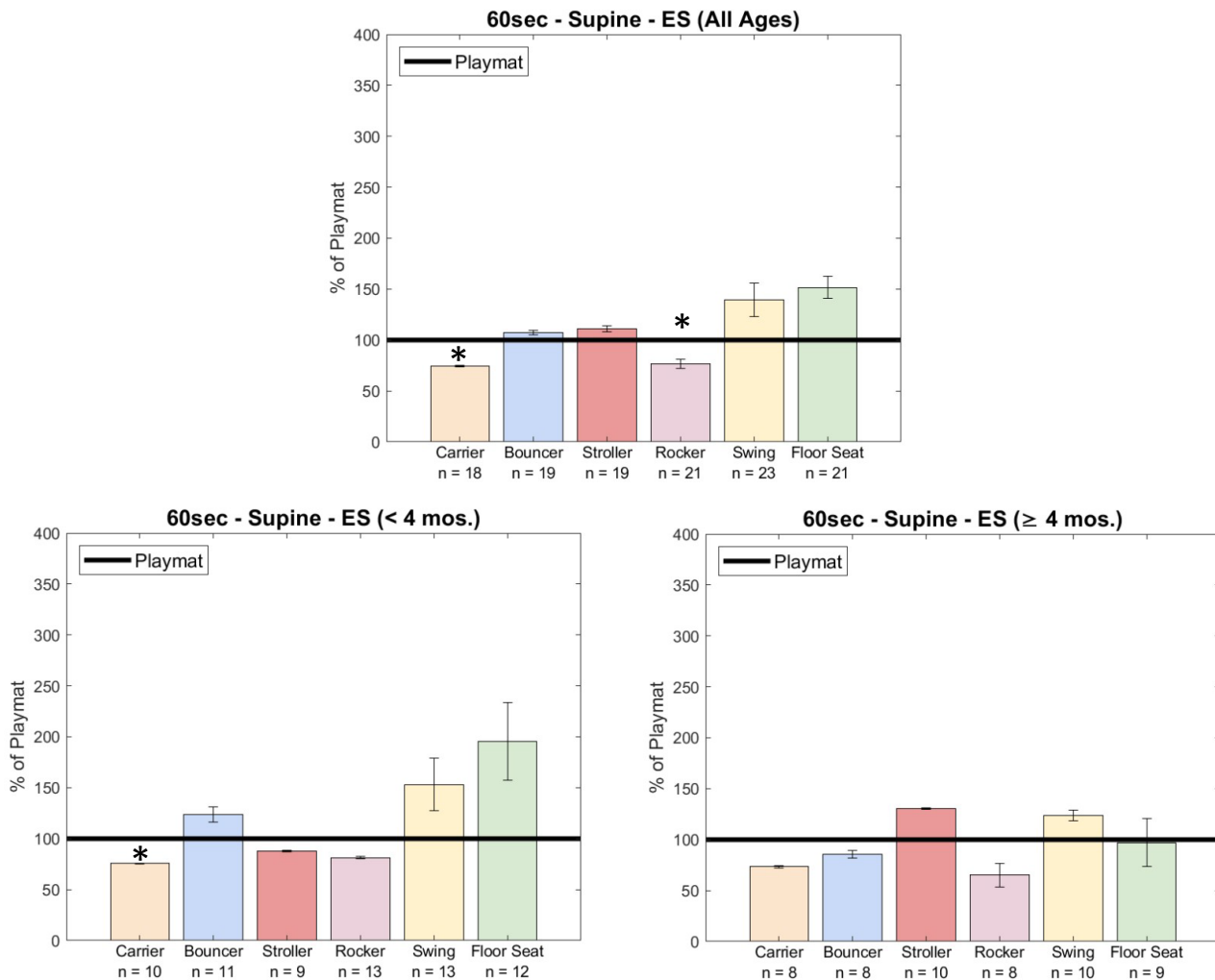
The EMG results of the cervical paraspinal (CP) muscles for the supine lying condition are presented as **Figure 71**. As expected, infants had higher levels of muscle activity (on average 75% more than the playmat condition) in the infant floor seat position, which features no head support. In the



**Figure 114.** Bilateral mean ( $\pm$ standard error) EMG values for cervical paraspinal (CP) muscles of infants during supine lying in all conditions. The black line represents the playmat, and all data was normalized to this value. Top: data for all infants; Right: data for younger infants; and Left: data for older infants. \* $p < 0.05$  vs. the playmat condition.

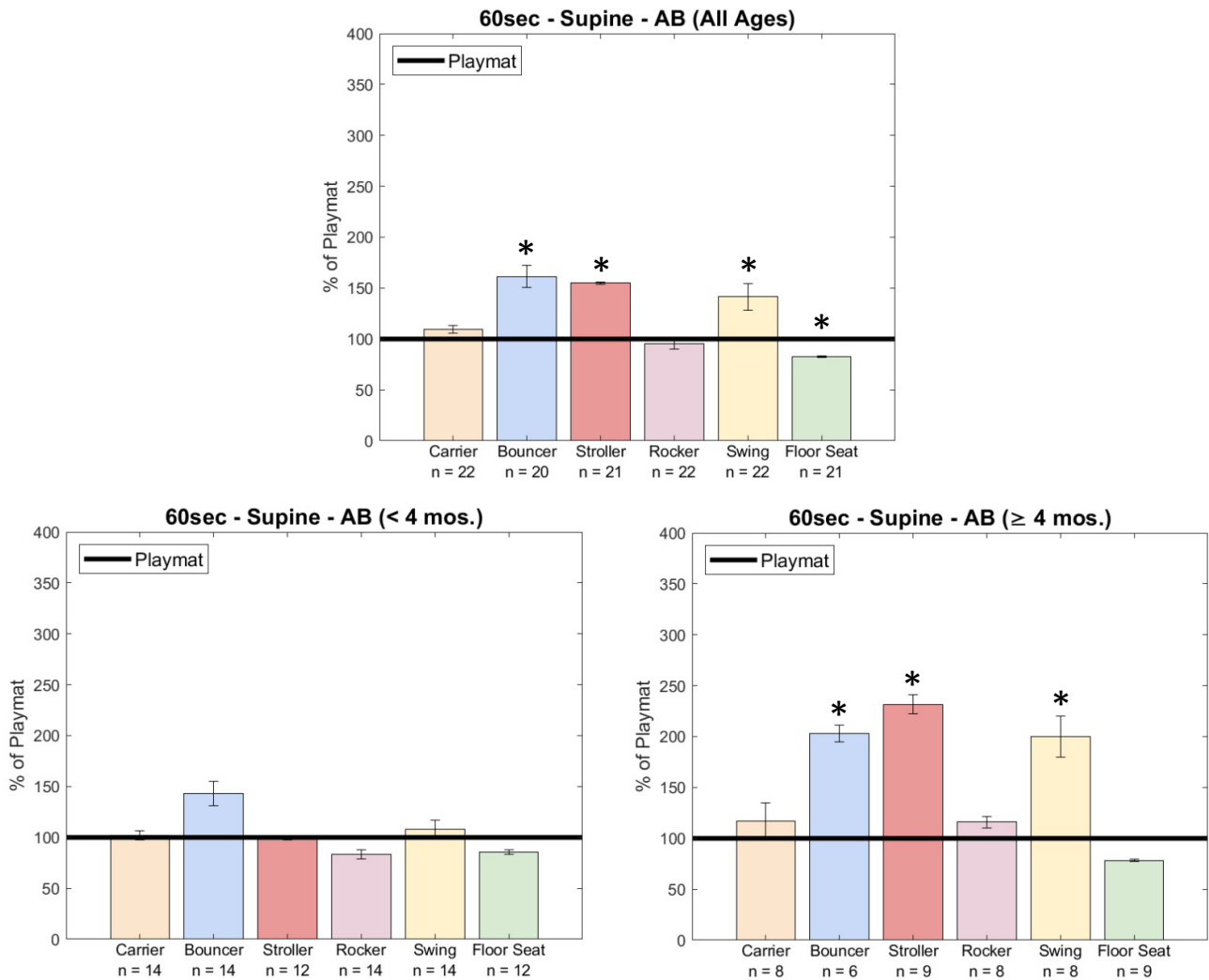
infant carrier, older infants used their cervical paraspinals on average 45% less than they did in the playmat condition ( $p < 0.05$ ). In general, younger infants required more use of their neck muscles compared to older infants, though statistical significance was not reached because this comparison was underpowered as expected.

The EMG results of the erector spinae (ES) muscles for the supine lying condition are presented as **Figure 72**. Infants used their back muscles less in the infant carrier and rocker conditions ( $p < 0.05$ ), exhibiting approximately 23% (rocker) and 25% (infant carrier) less muscle activity compared to the playmat condition.



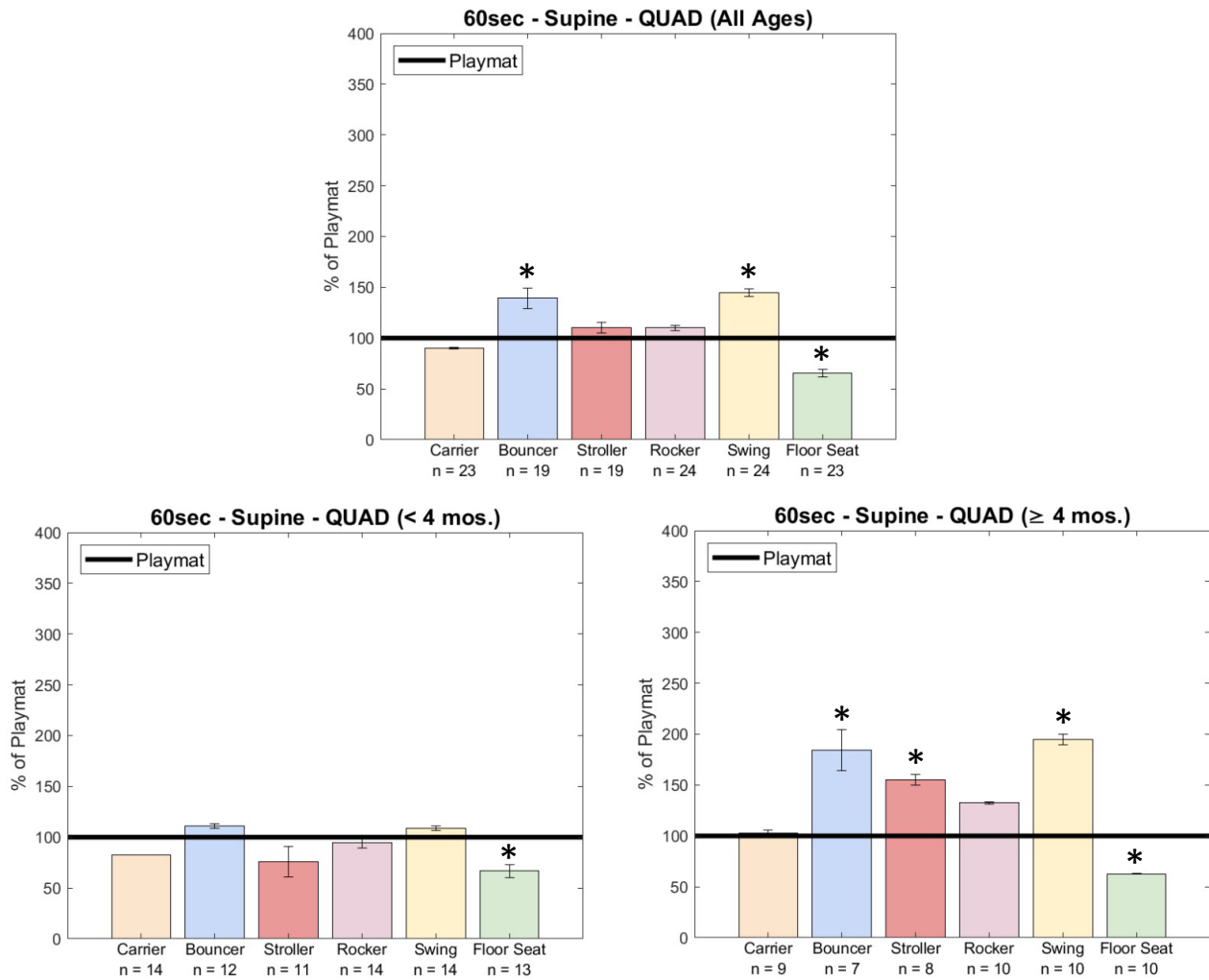
**Figure 123.** Bilateral mean ( $\pm$ standard error) EMG values for erector spinae (ES) muscles of infants during supine lying in all conditions. The black line represents the playmat, and all data was normalized to this value. Top: data for all infants; Right: data for younger infants; and Left: data for older infants. \* $p < 0.05$  vs. the playmat condition.

The EMG results of the abdominal (AB) muscles for the supine lying condition are presented as **Figure 73**. We found significant differences between the younger and the older infants in the bouncer, stroller, and swing conditions for the abdominal muscle activity ( $p < 0.05$ ). The older infants used their core muscles approximately twice as much in the stroller and swing than the younger infants did.



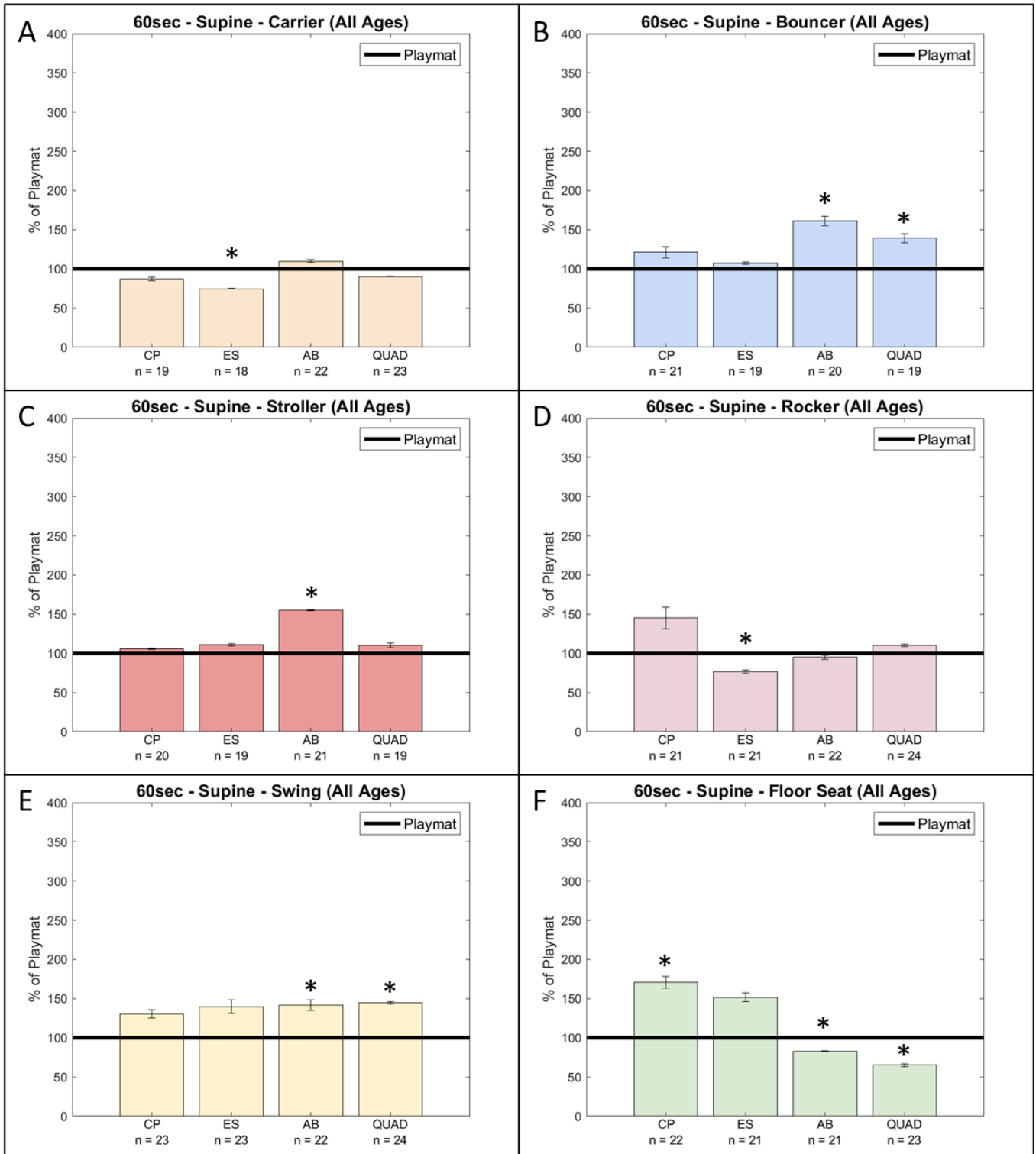
**Figure 124.** Bilateral mean ( $\pm$ standard error) EMG values for abdominal (AB) muscles of infants during supine lying in all conditions. The black line represents the playmat, and all data was normalized to this value. Top: data for all infants; Right: data for younger infants; and Left: data for older infants. \* $p < 0.05$  vs. the playmat condition.

The EMG results of the quadriceps (QUAD) muscles for the supine lying condition are presented as **Figure 74**. Infants used their quadriceps muscles less in the infant floor seat condition ( $p < 0.05$ ), exhibiting on average 34% less muscle activity compared to the playmat condition. We found significant differences between the younger and the older infants in the bouncer, stroller, and swing conditions for the quadriceps muscle activity ( $p < 0.05$ ). The older infants used their leg muscles nearly twice as much in the bouncer and swing than the younger infants did.



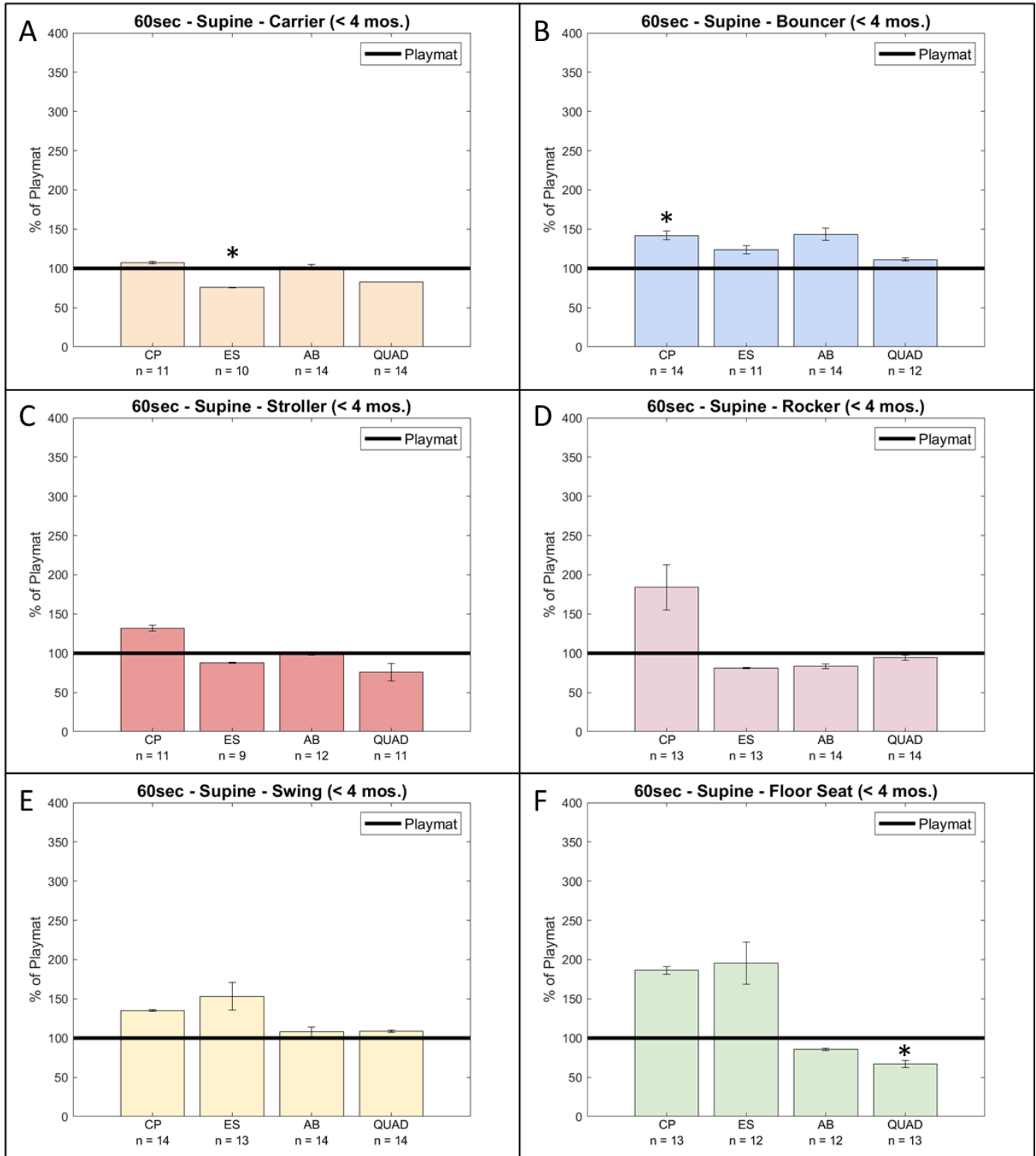
**Figure 125.** Bilateral mean ( $\pm$ standard error) EMG values for quadriceps (QUAD) muscles of infants during supine lying in all conditions. The black line represents the playmat, and all data was normalized to this value. Top: data for all infants; Right: data for younger infants; and Left: data for older infants. \* $p < 0.05$  vs. the playmat condition.

We also plotted the same data from the 60 second trial of supine lying with all muscle groups grouped by product category. **Figure 75** shows the data for all infants in the study.

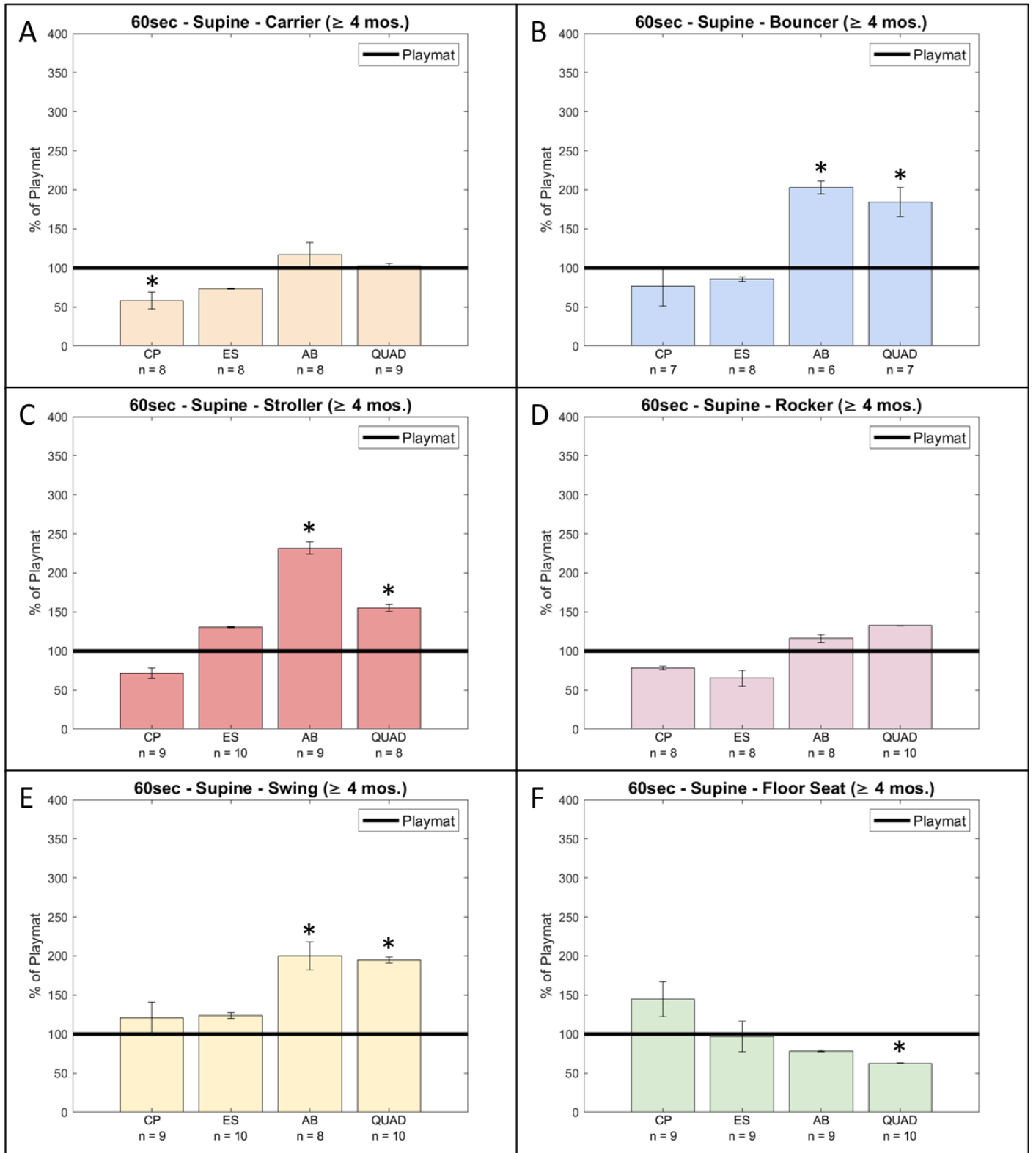


**Figure 126.** Bilateral mean ( $\pm$ standard error) EMG values for all muscle groups of all infants during supine lying, grouped by product type (A) infant carriers, (B) bouncers, (C) strollers, (D) rockers, (E) swings, and (F) infant floor seats. The black line represents the playmat, and all data was normalized to this value. \* $p < 0.05$  vs. the playmat condition.

We separated the data into younger infants (**Figure 76**) and older infants (**Figure 77**).



**Figure 135.** Bilateral mean ( $\pm$ standard error) EMG values for all muscle groups of infants < 4 months during supine lying, grouped by product type (A) infant carriers, (B) bouncers, (C) strollers, (D) rockers, (E) swings, and (F) infant floor seats. The black line represents the playmat, and all data was normalized to this value. \* $p < 0.05$  vs. the playmat condition.

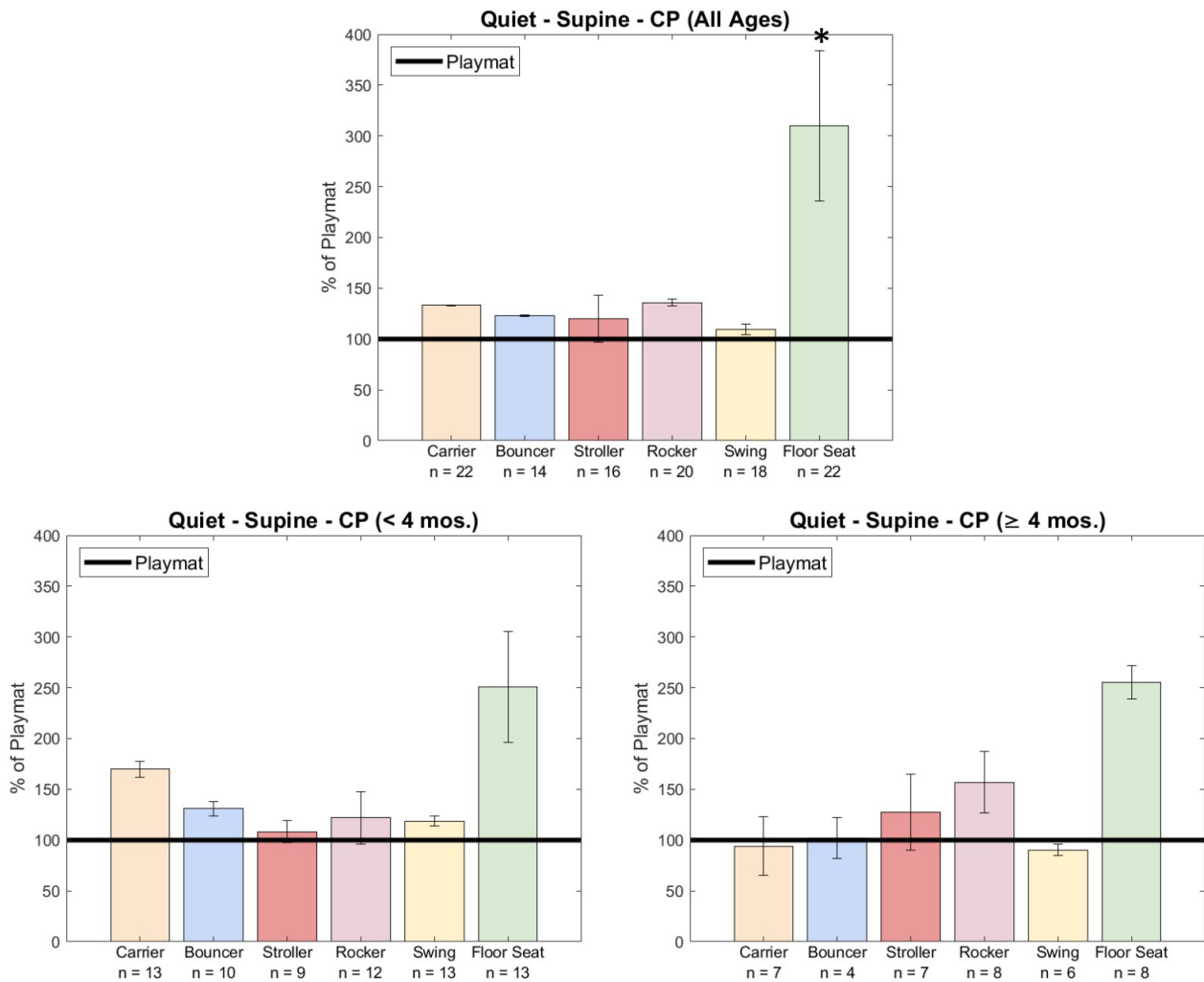


**Figure 144.** Bilateral mean ( $\pm$ standard error) EMG values for all muscle groups of infants  $\geq 4$  months during supine lying, grouped by product type (A) infant carriers, (B) bouncers, (C) strollers, (D) rockers, (E) swings, and (F) infant floor seats. The black line represents the playmat, and all data was normalized to this value. \* $p < 0.05$  vs. the playmat condition.



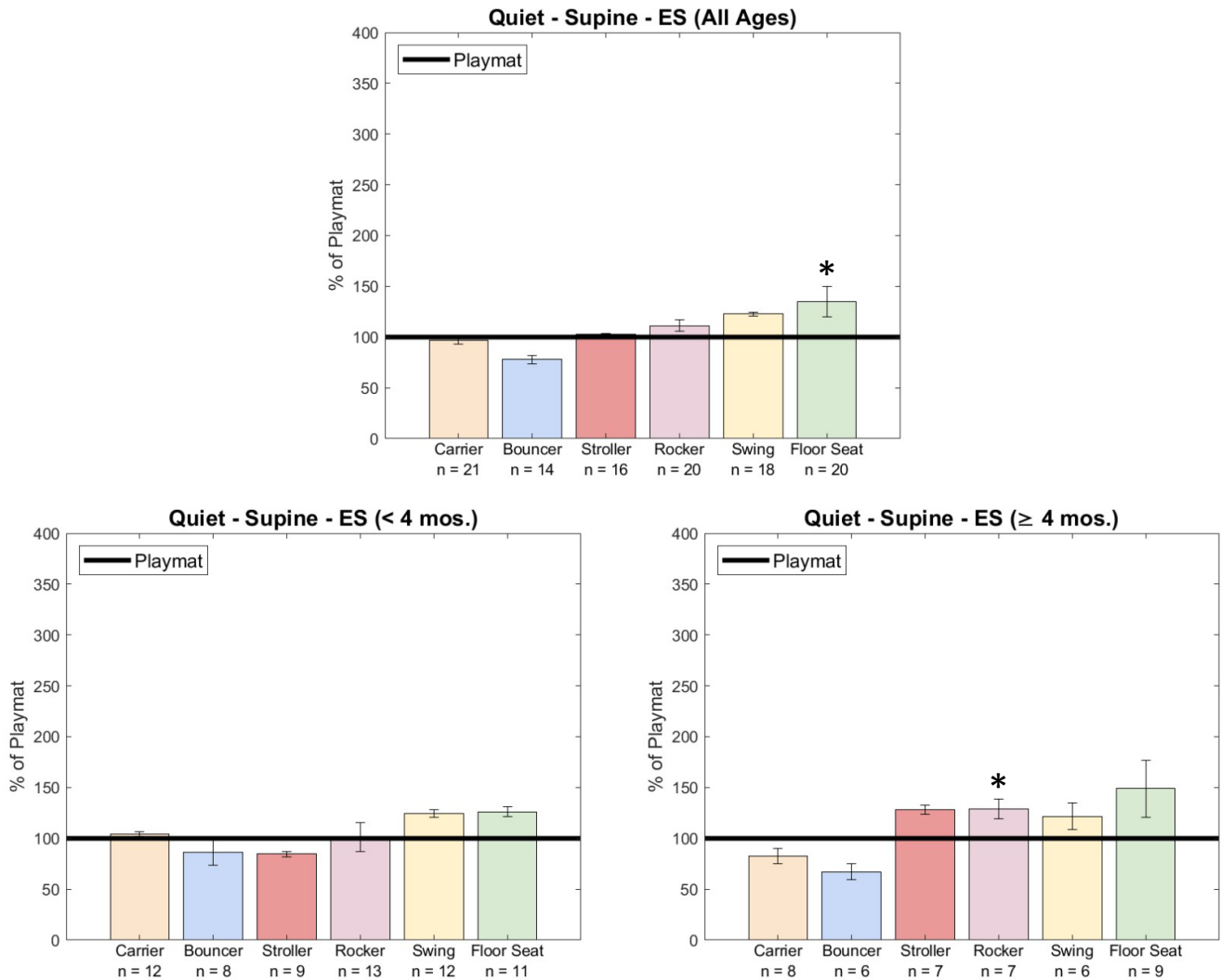
During the 60 second trials, older infants used their abdominal muscles and quadriceps muscles significantly more in the bouncer, stroller, and swing conditions than they did on a flat surface, while this same trend was not present for the younger infants. The high abdominal muscle activity could benefit older infants in an awake and attended state. Core strength is a key requirement in obtaining many motor milestones such as rolling and sitting (Altmann and Hill, 2019; Morea et al., 2020), so some use of some seated products while awake and supervised may benefit infants  $\geq 4$  months of age in strengthening these muscle groups. For younger infants, only one muscle group in one condition (cervical paraspinals in the bouncer) increased muscle activity, meaning that younger infants may not gain many benefits while in a seated product from a muscle use or motor development perspective.

The EMG results of the cervical paraspinal (CP) muscles for the supine lying condition during quiet lying are presented as **Figure 78**. As expected, infants exhibited more muscle activity (approximately 3 times more than the playmat condition) in the infant floor seat position, which features no head support.



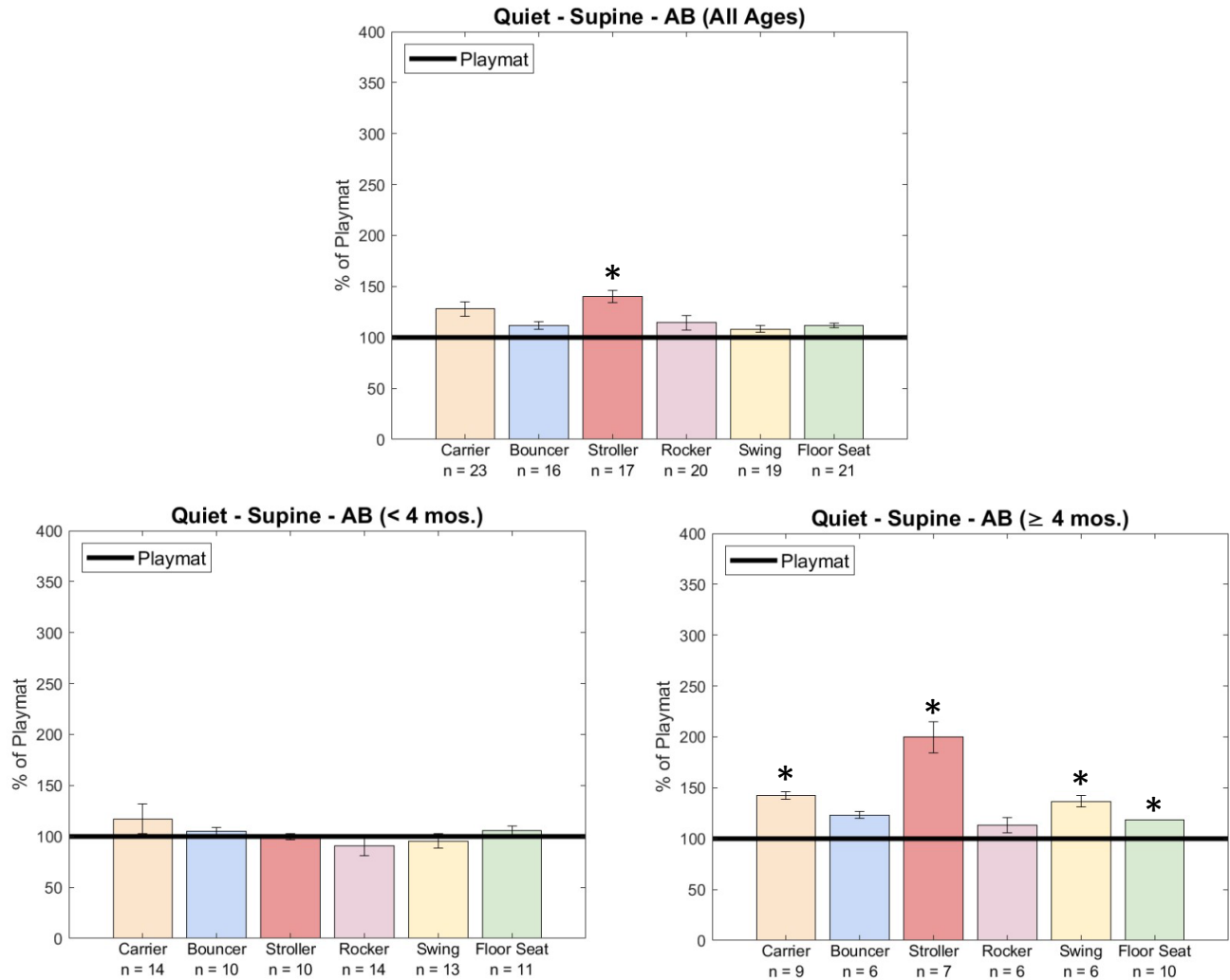
**Figure 153.** Bilateral mean ( $\pm$ standard error) EMG values for cervical paraspinal (CP) muscles of infants during quiet supine lying in all conditions. The black line represents the playmat, and all data was normalized to this value. Top: data for all infants; Right: data for younger infants; and Left: data for older infants. \* $p < 0.05$  vs. the playmat condition.

The EMG results of the erector spinae (ES) muscles for the supine lying condition are presented as **Figure 79**. Infants used their back muscles more in the infant floor seat condition ( $p < 0.05$ ), exhibiting on average 40% more muscle activity compared to the playmat condition.



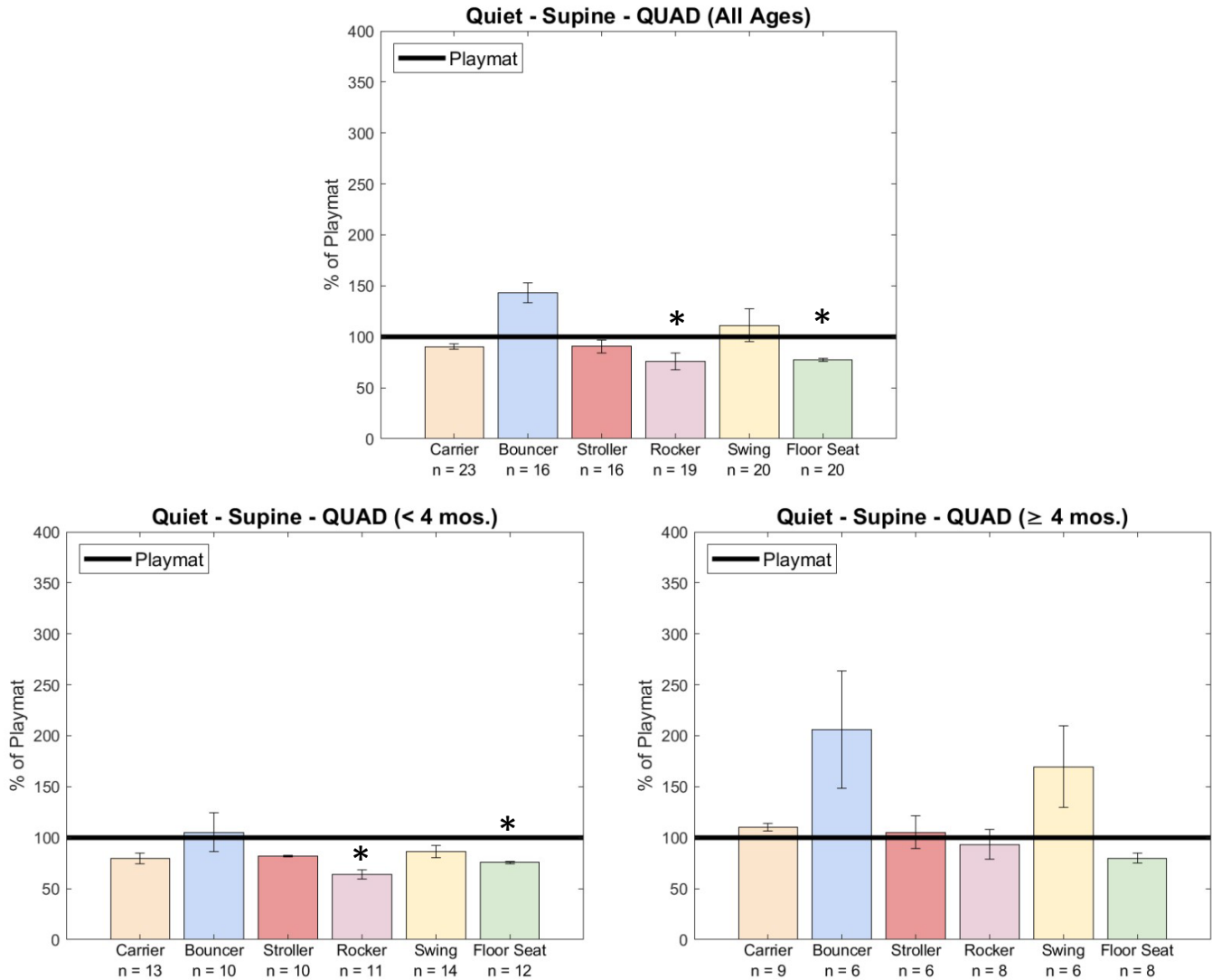
**Figure 154.** Bilateral mean ( $\pm$ standard error) EMG values for erector spinae (ES) muscles of infants during quiet supine lying in all conditions. The black line represents the playmat, and all data was normalized to this value. Top: data for all infants; Right: data for younger infants; and Left: data for older infants. \* $p < 0.05$  vs. the playmat condition.

The EMG results of the abdominal (AB) muscles for the supine quiet lying condition are presented as **Figure 80**. The older infants used their core muscles approximately more in the infant carrier, stroller, swing, and infant floor seat compared to the younger infants ( $p < 0.05$ ). The results from the younger infants show that in quiet lying, infants are not activating their muscles differently than they do on a firm flat surface, while older infants are activating their core muscles.



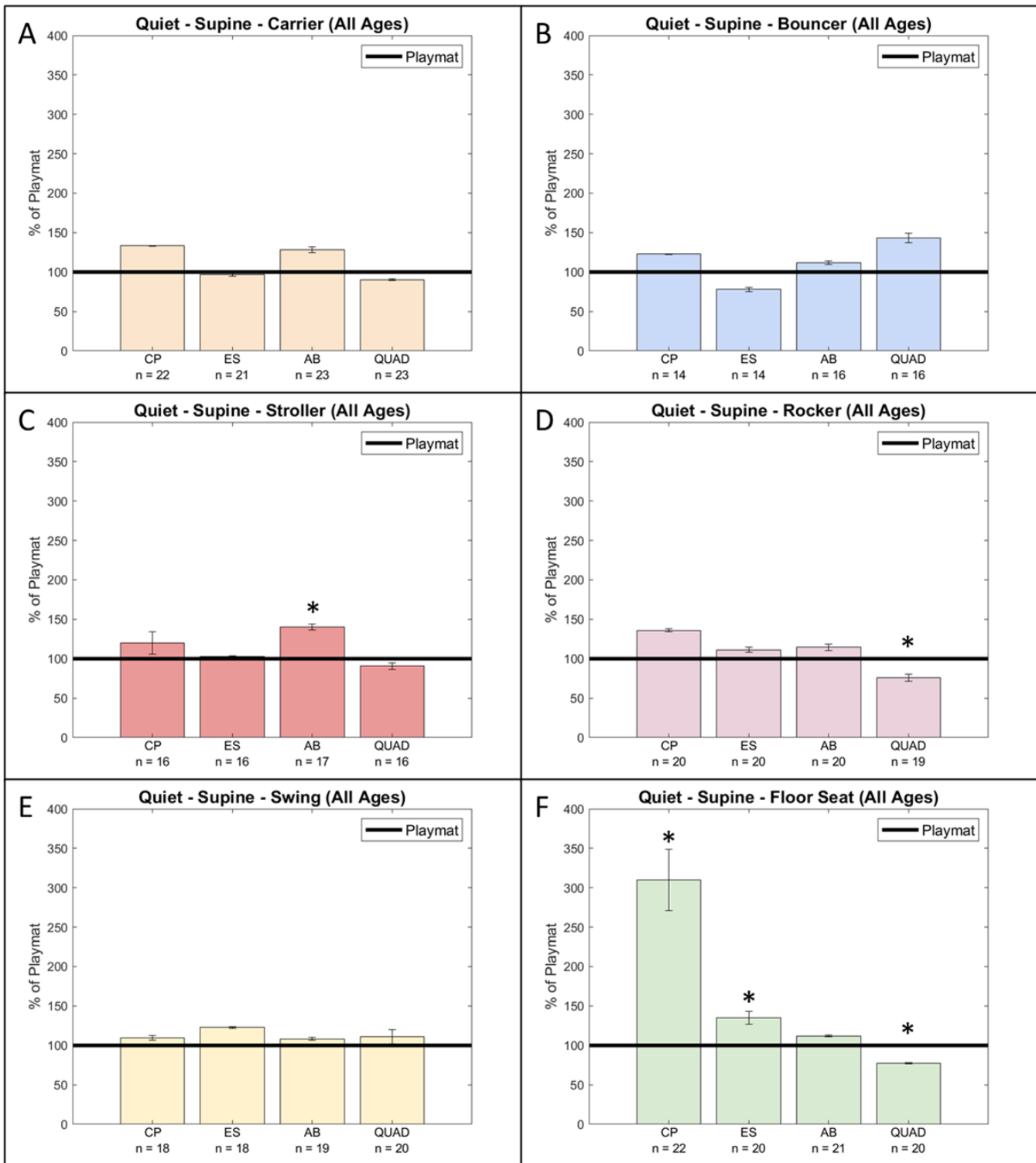
**Figure 155.** Bilateral mean ( $\pm$ standard error) EMG values for abdominal (AB) muscles of infants during quiet supine lying in all conditions. The black line represents the playmat, and all data was normalized to this value. Top: data for all infants; Right: data for younger infants; and Left: data for older infants. \* $p < 0.05$  vs. the playmat condition.

The EMG results from the quadriceps muscles during the 60 second supine lying trials are presented as **Figure 81**. Older infants significantly increased their quadriceps muscle activity in the bouncer, stroller, and swing, while all infants decreased their muscle activity in the infant floor seat. During testing, older infants sometimes pressed their feet against the seat portion or frame of the seated products, especially the bouncer and swing. In the same products, younger infants did not experience any increases in quadriceps muscle activity for any seated products.



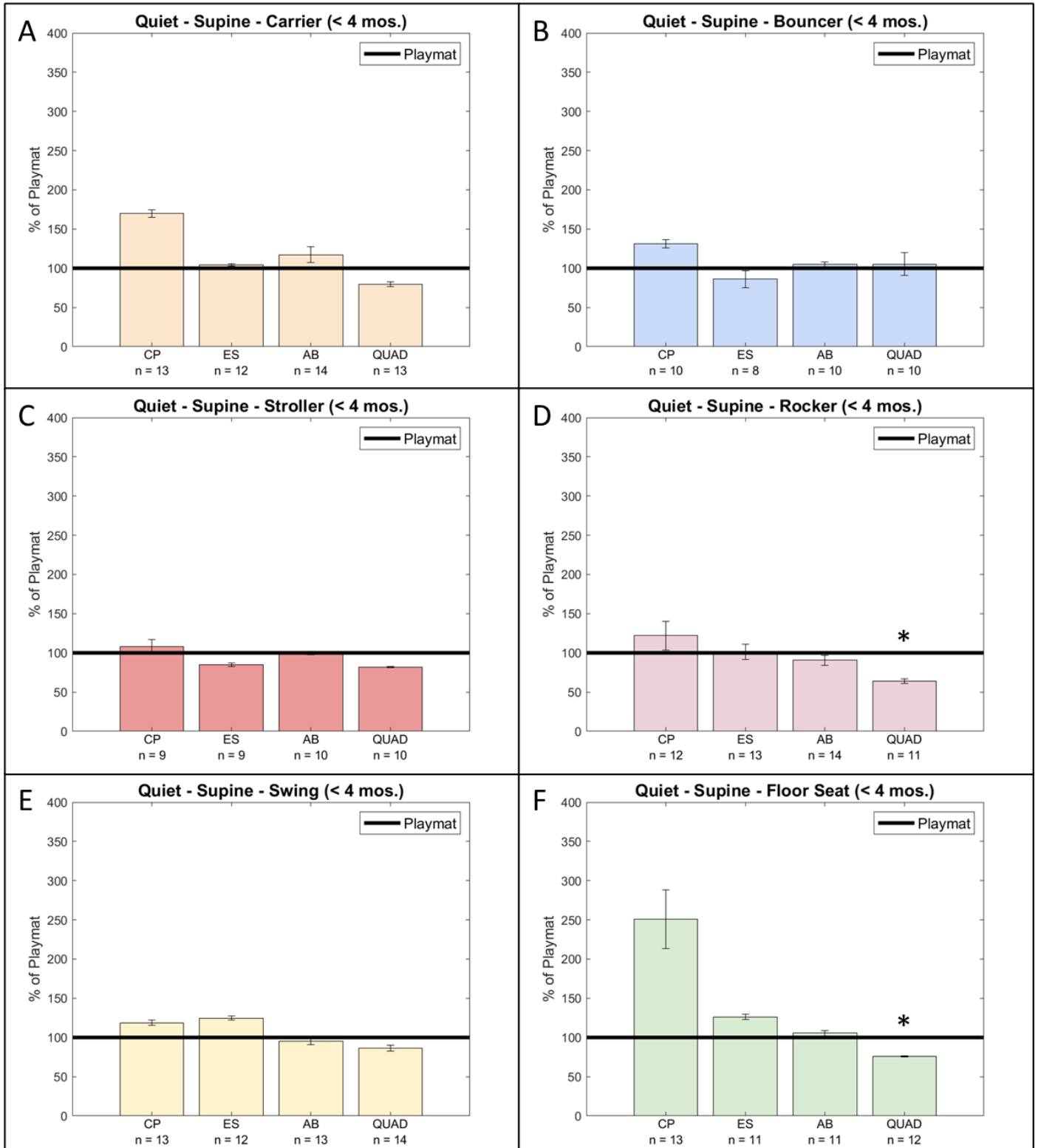
**Figure 156.** Bilateral mean ( $\pm$ standard error) EMG values for quadriceps (QUAD) muscles of infants during quiet supine lying in all conditions. The black line represents the playmat, and all data was normalized to this value. Top: data for all infants; Right: data for younger infants; and Left: data for older infants. \* $p < 0.05$  vs. the playmat condition.

As we did for the 60 second trials, we separated the data to examine muscle use of all infants during supine quiet lying in each product as a representation of a sleep state (**Figure 82**).



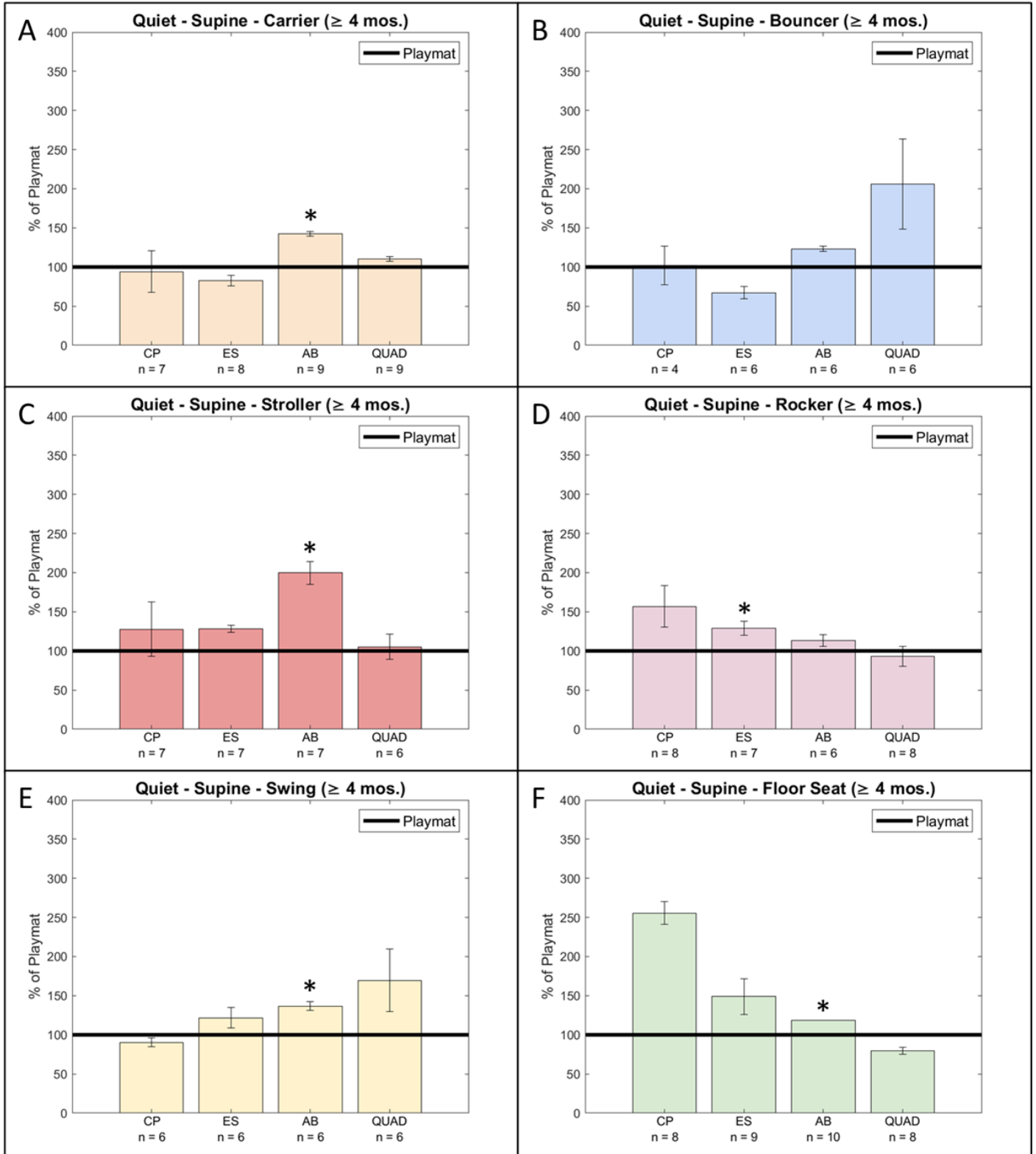
**Figure 157.** Bilateral mean ( $\pm$ standard error) EMG values for all muscle groups of all infants during supine quiet lying, grouped by product type (A) infant carriers, (B) bouncers, (C) strollers, (D) rockers, (E) swings, and (F) infant floor seats. The black line represents the playmat, and all data was normalized to this value. \* $p < 0.05$  vs. the playmat condition.

We separated the data into younger infants (**Figure 83**) and older infants (**Figure 84**).



**Figure 166.** Bilateral mean ( $\pm$ standard error) EMG values for all muscle groups of younger infants during supine quiet lying, grouped by product type (A) infant carriers, (B) bouncers, (C) strollers, (D) rockers, (E) swings, and (F) infant floor seats. The black line represents the playmat, and all data was normalized to this value. \* $p < 0.05$  vs. the playmat condition.



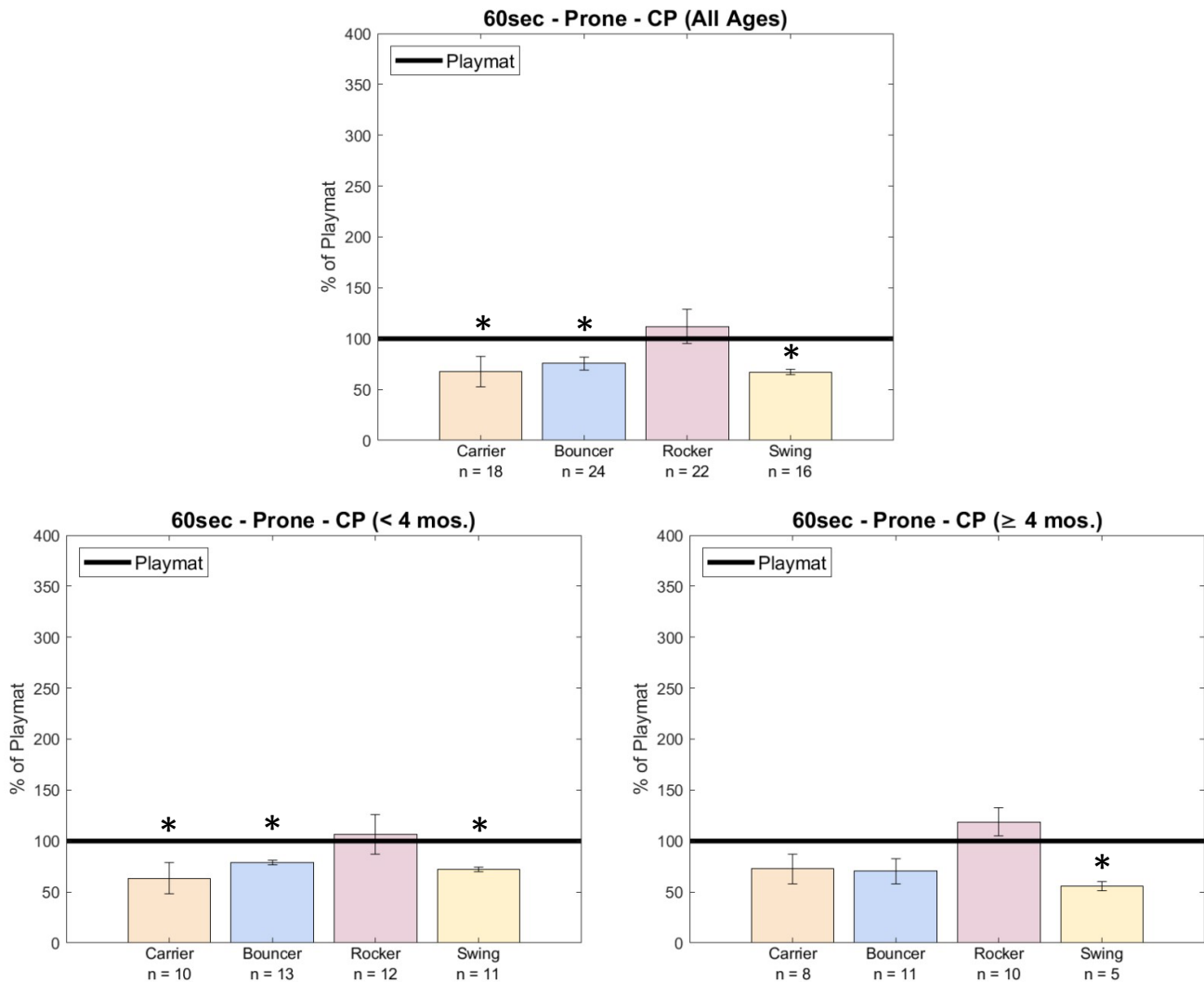


**Figure 167.** Bilateral mean ( $\pm$ standard error) EMG values for all muscle groups of older infants during supine quiet lying, grouped by product type (A) infant carriers, (B) bouncers, (C) strollers, (D) rockers, (E) swings, and (F) infant floor seats. The black line represents the playmat, and all data was normalized to this value. \* $p < 0.05$  vs. the playmat condition.

The quiet lying data is the closest representation we have of how infants would be lying during a sleep state in this study. We know that infant's muscles relax during sleep (Blumberg, 2016; Davis et al., 2004; Schwarz et al., 2012), so these results of infants in quiet lying are an over-estimation of the sleep state. Interestingly, in most products, the older infants are engaging their abdominal muscles, which are used for respiration and for body positioning. Conversely, younger infants are not engaging these muscles, meaning they rely more on the product to dictate their body positions compared to their own strength. During sleep, we expect all muscle groups to relax even more, meaning that the infant's body position will be solely dependent upon their interaction with the product.

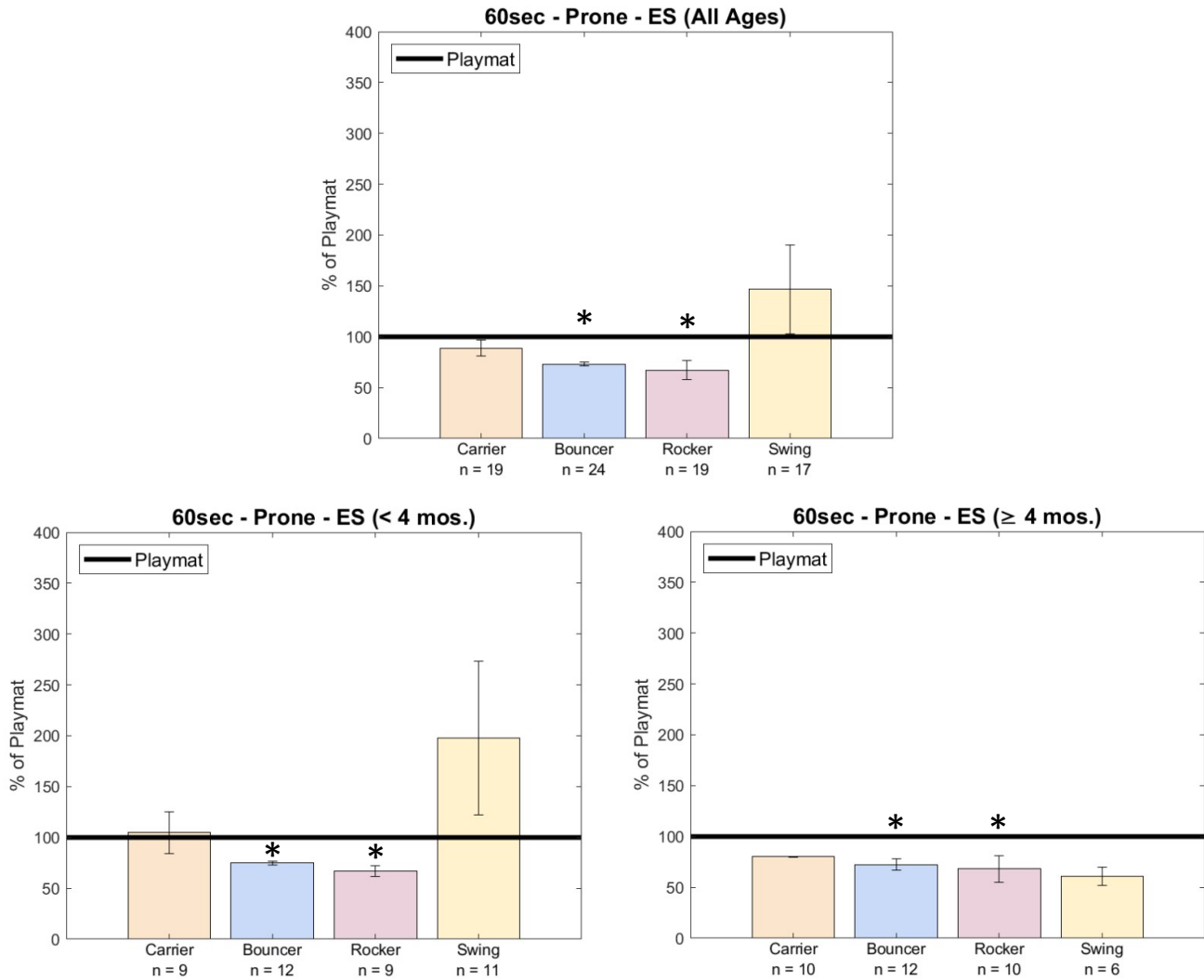
8.3.3.2 Prone Lying

The EMG results of the cervical paraspinal (CP) muscles for the prone lying condition are presented as **Figure 85**. Infants required less use of their neck muscles while prone in the infant carrier, bouncer, and swing compared to the playmat condition.



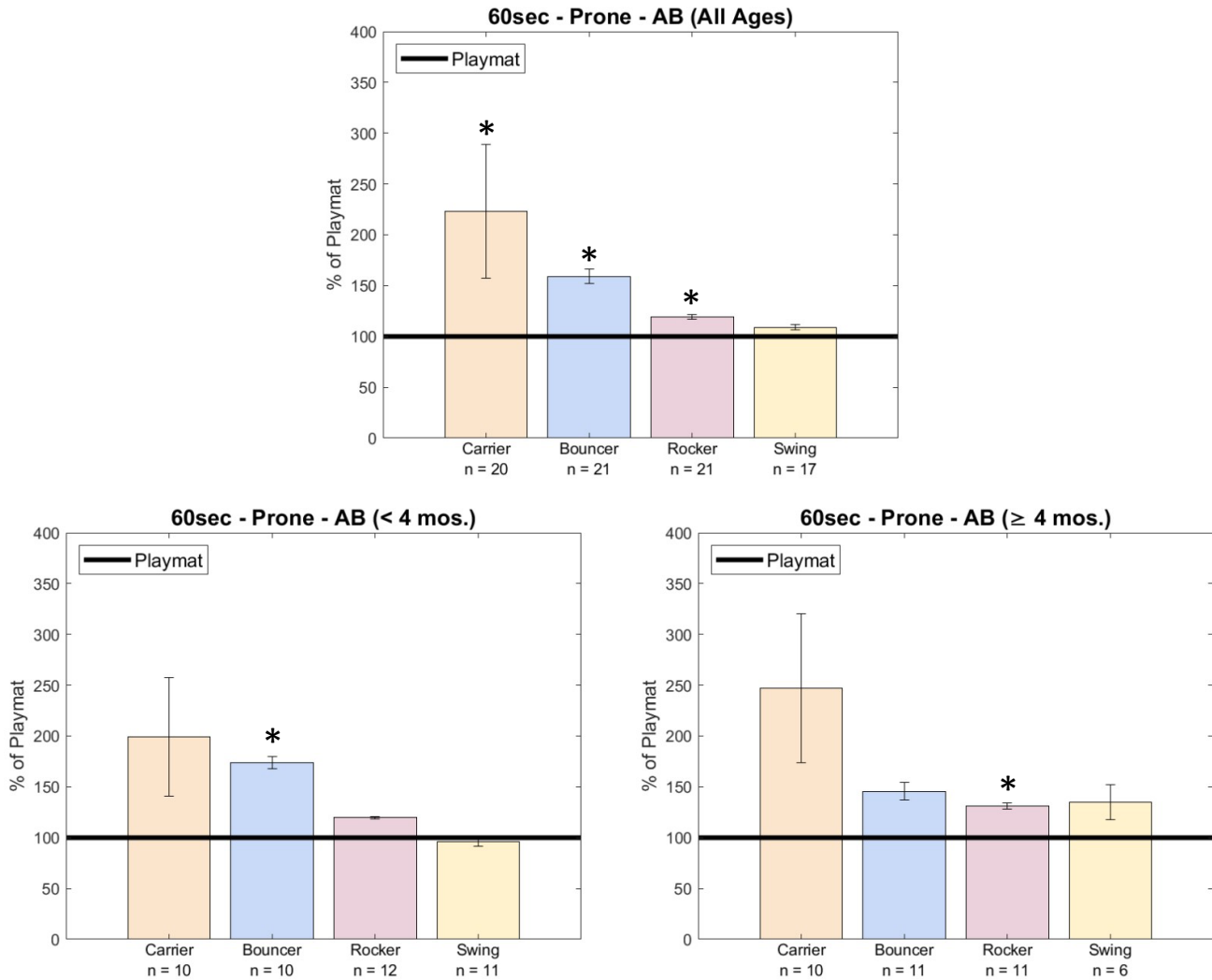
**Figure 168.** Bilateral mean ( $\pm$ standard error) EMG values for cervical paraspinal (CP) muscles of infants during prone lying in all conditions. The black line represents the playmat, and all data was normalized to this value. Top: data for all infants; Right: data for younger infants; and Left: data for older infants. \* $p < 0.05$  vs. the playmat condition.

The EMG results of the erector spinae (ES) muscles for the prone lying condition are presented as **Figure 86**. Infants used their back muscles less in the bouncer and rocker conditions compared to the playmat condition ( $p < 0.05$ ).



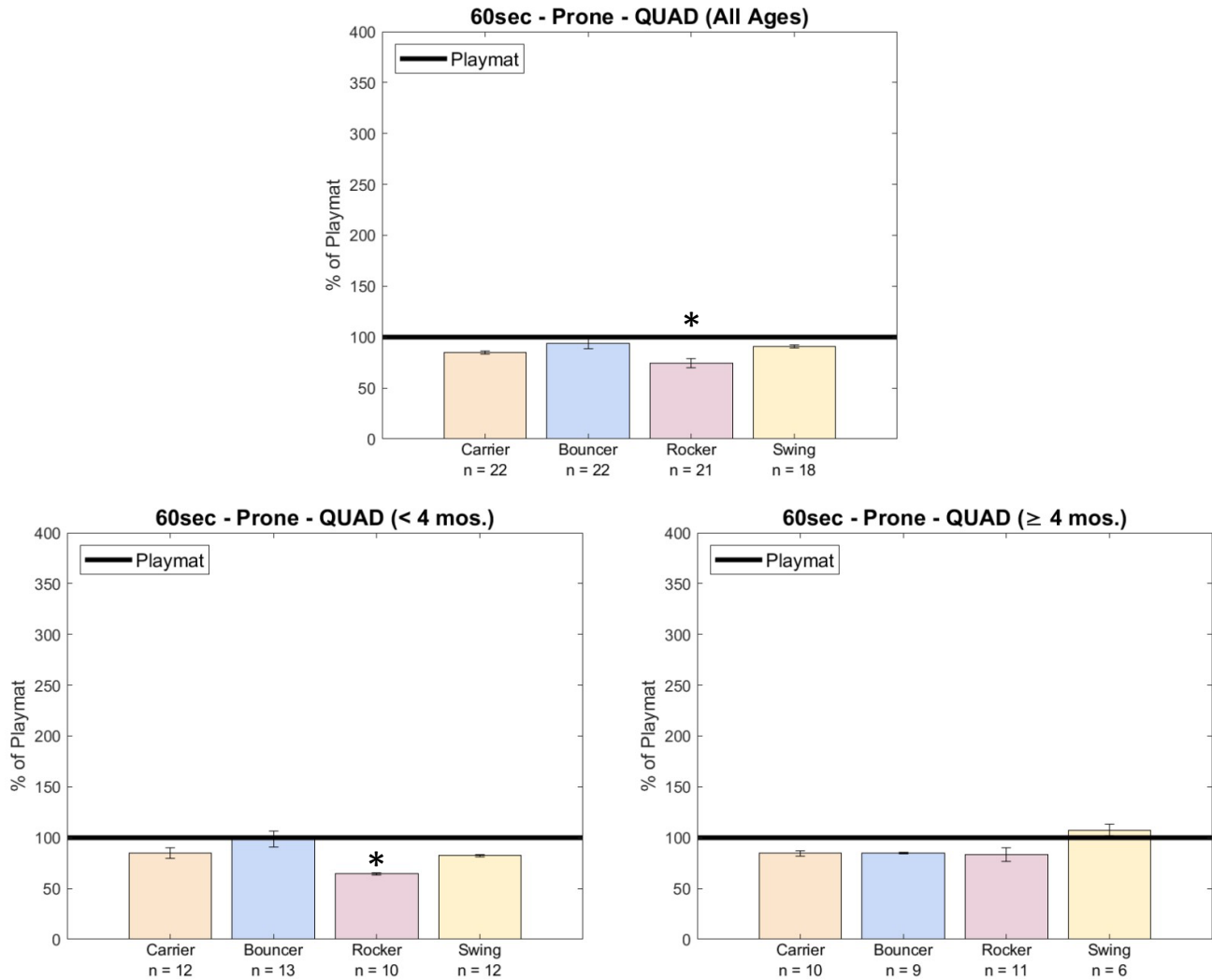
**Figure 177.** Bilateral mean ( $\pm$ standard error) EMG values for erector spinae (ES) muscles of infants during prone lying in all conditions. The black line represents the playmat, and all data was normalized to this value. Top: data for all infants; Right: data for younger infants; and Left: data for older infants. \* $p < 0.05$  vs. the playmat condition.

The EMG results of the abdominal (AB) muscles for the prone lying condition are presented as **Figure 87**. Infants used their core muscles over twice as much in the infant carrier, and on average 50% to 60% more in the bouncer condition compared to the playmat condition ( $p < 0.05$ ).



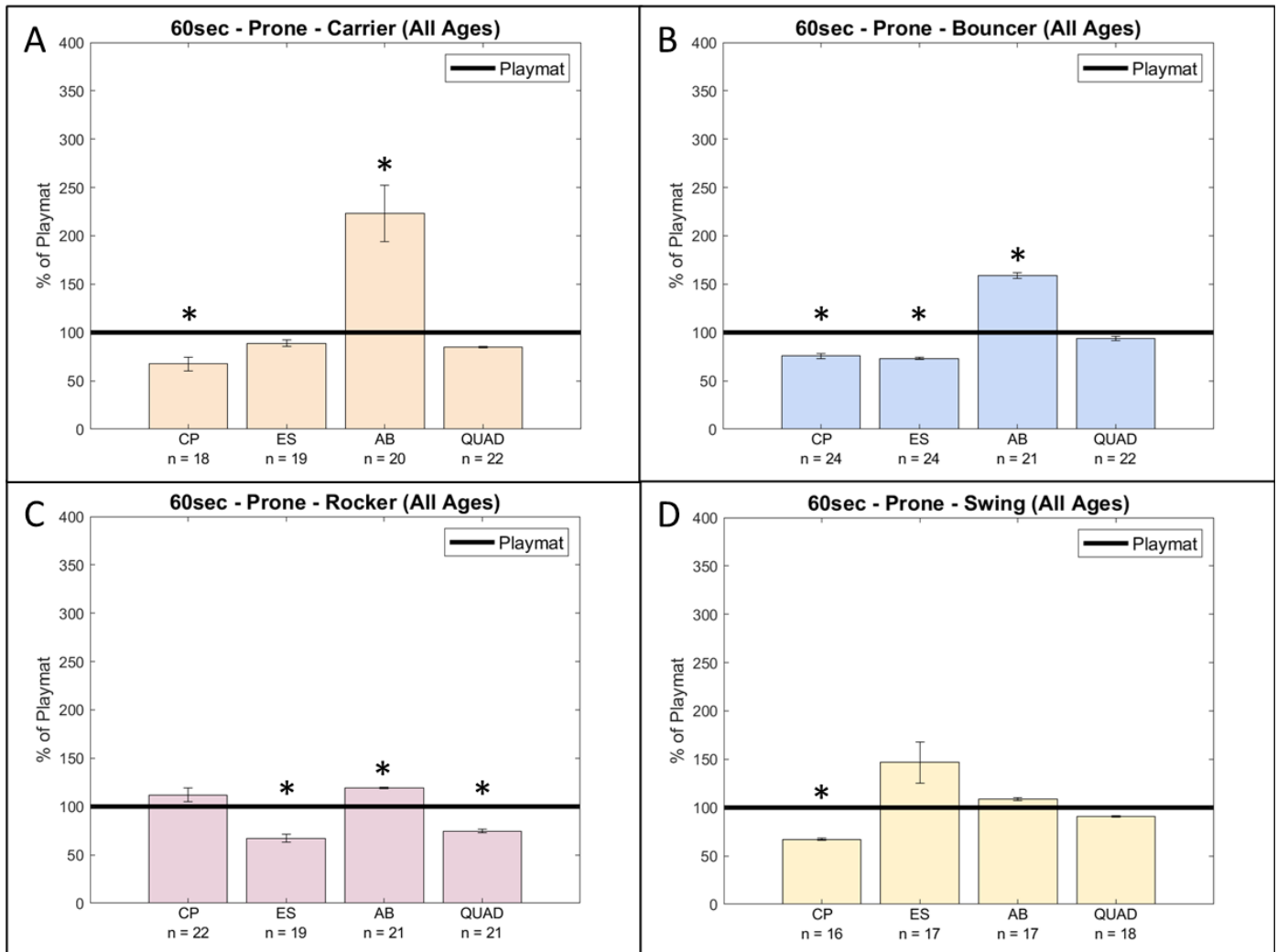
**Figure 186.** Bilateral mean ( $\pm$ standard error) EMG values for abdominal (AB) muscles of infants during prone lying in all conditions. The black line represents the playmat, and all data was normalized to this value. Top: data for all infants; Right: data for younger infants; and Left: data for older infants. \* $p < 0.05$  vs. the playmat condition.

The EMG results of the quadriceps (QUAD) muscles for the prone lying condition are presented as **Figure 88**. Infants used their quadriceps muscles on average 25% less in the rocker condition compared to the playmat condition ( $p < 0.05$ ).



**Figure 195.** Bilateral mean ( $\pm$ standard error) EMG values for quadriceps (QUAD) muscles of infants during prone lying in all conditions. The black line represents the playmat, and all data was normalized to this value. Top: data for all infants; Right: data for younger infants; and Left: data for older infants. \* $p < 0.05$  vs. the playmat condition.

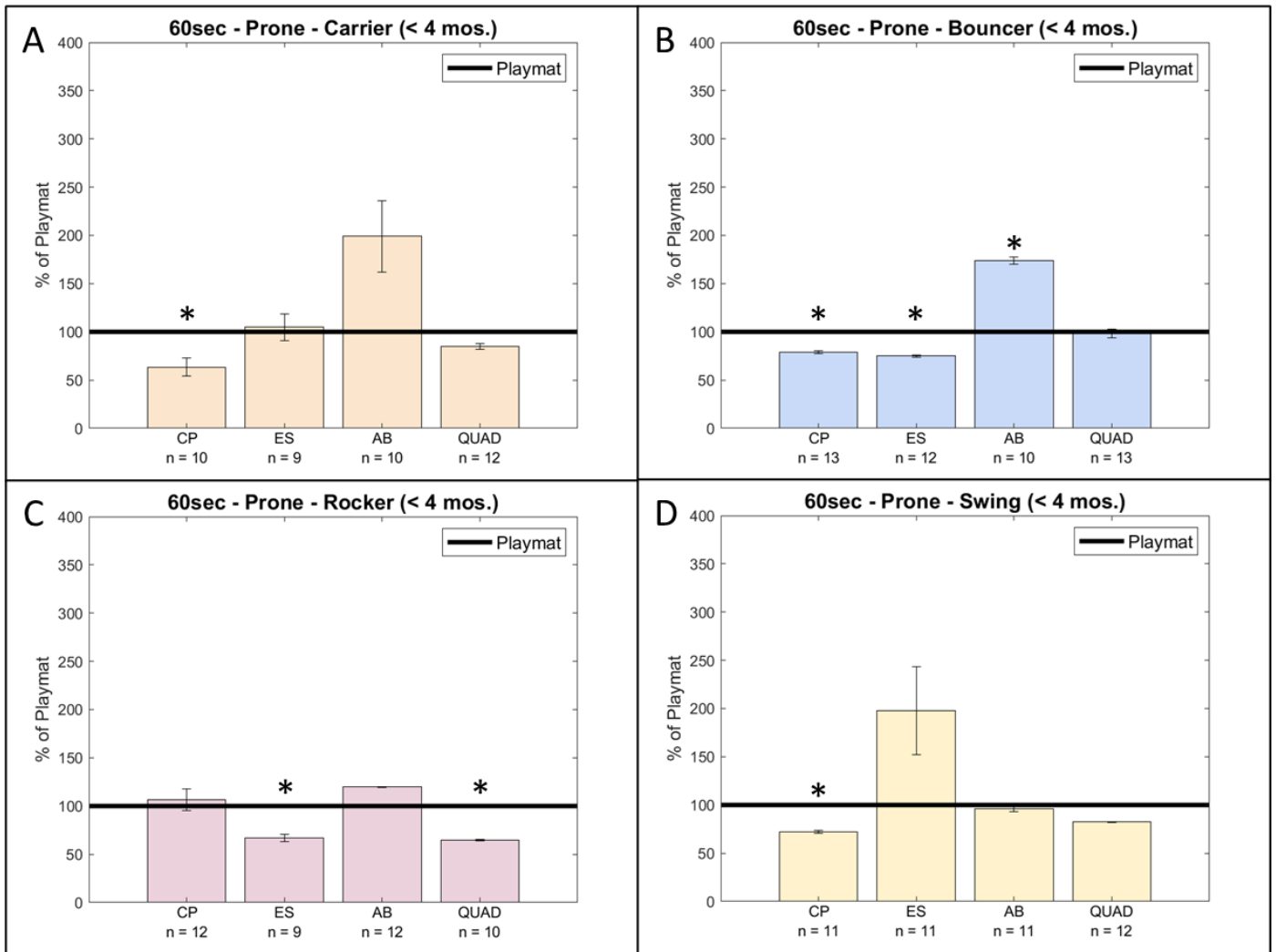
We also plotted the same data from the 60 second trial of prone lying with all muscle groups grouped by product category. **Figure 89** shows the data for all infants in the study.



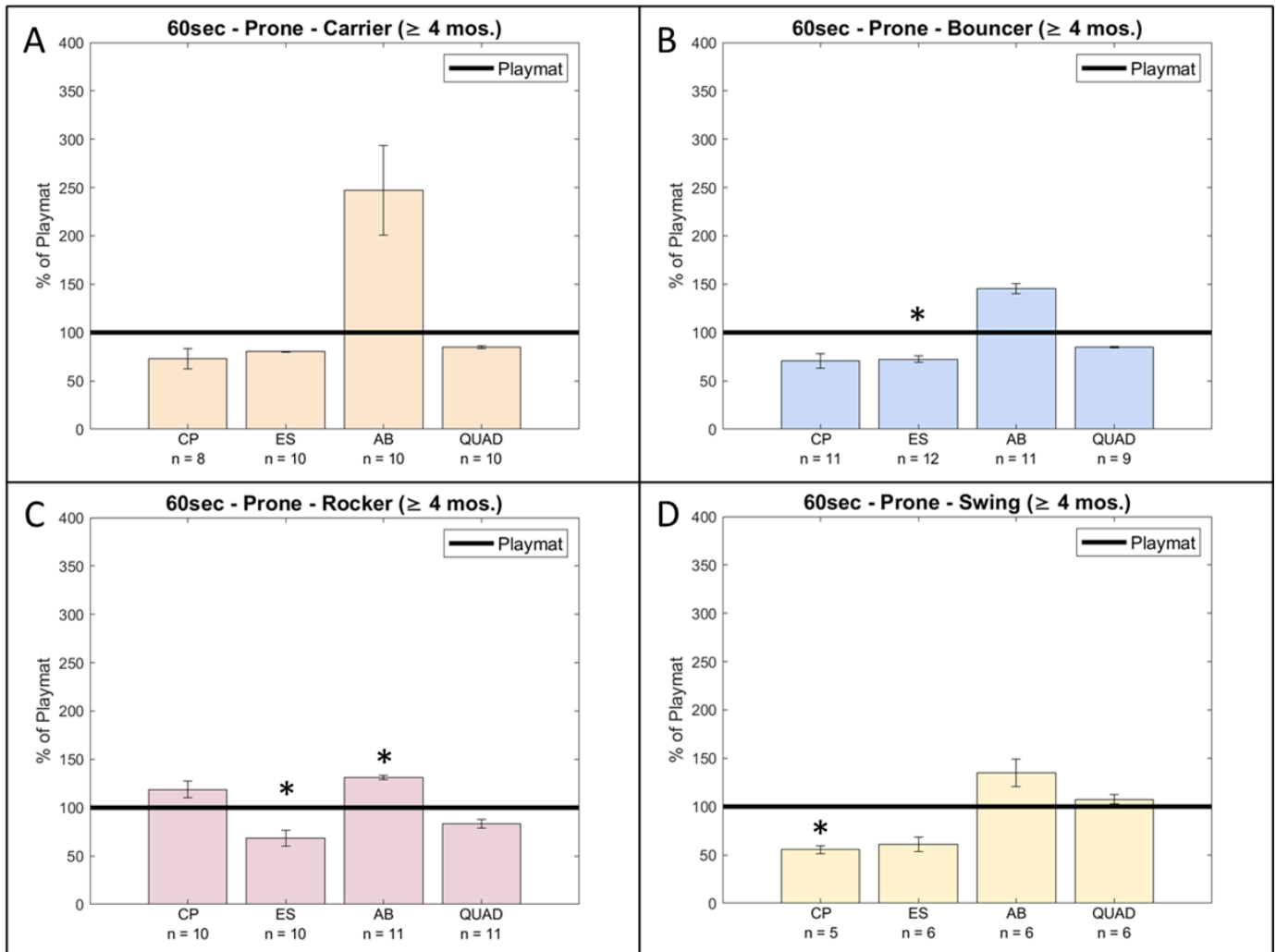
**Figure 204.** Bilateral mean ( $\pm$ standard error) EMG values for all muscle groups of all infants during prone lying, grouped by product type (A) infant carriers, (B) bouncers, (C) rockers, and (D) swings. The black line represents the playmat, and all data was normalized to this value. \* $p < 0.05$  vs. the playmat condition.



We separated the EMG data during prone lying into younger (**Figure 90**) and older (**Figure 91**) infants.



**Figure 213.** Bilateral mean ( $\pm$ standard error) EMG values for all muscle groups of younger infants during prone lying, grouped by product type (A) infant carriers, (B) bouncers, (C) rockers, and (D) swings. The black line represents the playmat, and all data was normalized to this value. \* $p < 0.05$  vs. the playmat condition.



**Figure 214.** Bilateral mean ( $\pm$ standard error) EMG values for all muscle groups of older infants during prone lying, grouped by product type (A) infant carriers, (B) bouncers, (C) rockers, and (D) swings. The black line represents the playmat, and all data was normalized to this value. \* $p < 0.05$  vs. the playmat condition.

For all infants during prone lying, abdominal muscle activity increased in all products except for the swing. When infants were positioned prone in the swing, the center of gravity shifted toward the top of the swing, causing it to rotate such that the infant was more parallel to the surface. In general, compared to the flat surface, infants used their neck and back muscles less than they did on the firm flat playmat. During prone lying, a head lift at an angle will require less force than the same head lift on a flat surface because the infant is working against gravity less in the inclined prone position. However, we also note that many infants did not lift their heads at all during the prone trials in the products, so this data could also be attributed to infants not attempting or not being able to use their neck and back muscles effectively while prone in the seated products.

## 8.4 *In vivo* Human Subjects Testing Discussion

Our human subjects testing revealed that in general, seated products significantly altered the body position, movement, and muscle activity of infants during both supine and prone lying.

### 8.4.1 Supine Lying

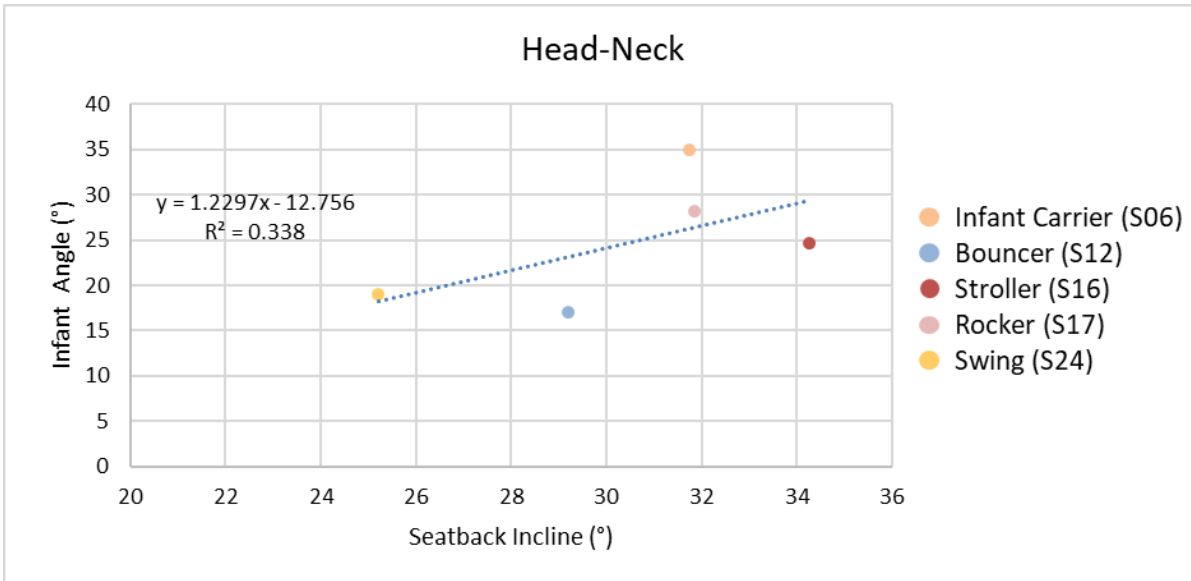
Kinematic variables such as head-neck flexion, trunk flexion, and torso-pelvis flexion were significantly increased during supine lying in most products.

Head-neck flexion magnitudes were higher in most seated products, and head-neck flexion movements increased in seated products compared to the firm flat playmat. Infants were often in a head-neck position of  $>30^\circ$  in the products which they rarely reached on the firm flat surface. However, on the firm flat surface, infants exhibited larger excursions because they were not constricted by a product so they were free to move as they wished. In spite of their freedom of movement, infants almost never moved into a head-neck flexion position of  $>30^\circ$  on the playmat. While no significant differences were found between the younger and older age groups, this may be due to the small sample sizes of each age group.

When in the intended position, head-neck flexion was significantly higher (median  $>10^\circ$ ) for the infant carrier, bouncer, stroller, rocker, and the swing, which represent all products analyzed. Trunk flexion was significantly higher (median  $>15^\circ$ ) for the bouncer, rocker, and swing, which represent all products analyzed. Previous research found that head-neck position is an important determinant of airway collapsibility in infants. Head-neck flexion of just  $15^\circ$  to  $30^\circ$  increases collapsibility by 4 to 5 cm  $H_2O$ , showing that exhalation speed was increased and lung capacity on inhale could decrease (Wilson et al., 1980). This means that all seated products we studied could potentially increase the risk of airway collapsibility and could reduce breathing abilities for at least some infants.

We expected that the seatback incline angle of the devices (as measured simply with the infant-sized hinged weight gauge device) would correlate with the head-neck angle of our human subjects data. Results show that there is a moderate correlation ( $r = 0.581$ ) between the back incline angle and the head-neck angle of participants (**Figure 92**), meaning that as the incline angle of a product increases, that an infant's head-neck angle increases also. Further, 33.8% of the variation in head/neck angle can be attributed to the back incline angle, meaning that there are also factors other than the incline angle

(such as concavity or conformity) affecting this change. Additional correlation analyses between the back incline angle and the body position of the infants in our study did not correlate, meaning that the trunk flexion and torso-pelvis flexion are influenced by factors other than the back incline angle as measured by the infant-sized hinged weight gauge.



**Figure 215.** Relationship between seatback incline of seated products and the average head/neck angle of the infants in our in vivo biomechanics study.

Previous research related to neck flexion and respiration shows that neck flexion is associated with increased total pulmonary resistance in both supine and semi-sitting positions (Carlo et al., 1989), and neck flexion lowers specific lung compliance in infants in a semi-sitting position. Other studies indicate that neck flexion can cause complete pharyngeal closure in infants (Reed et al., 1985; Thach and Stark, 1979). One study found that neck-flexion angles of just 45° significantly increased airflow interruption by 34.5% and increased severe airflow interruption by 17.6% compared to the neutral or flat surface position (Reiterer et al., 1994). Breathing was also affected for some infants at 45° of hyperextension. This shows that head-neck posture can alter airflow and pulmonary mechanics in infants. These changes may be further affected during rapid eye movement (REM) sleep because, compared to non-REM (NREM) sleep, REM sleep in children is characterized by increased upper airway collapsibility, reduced tone of the pharyngeal muscles, and decreased arousal response to hypoxia, resistive loading during inspiration, and hypercapnia (Huang et al., 2009; Katz et al., 2006; Katz et al., 2004; Marcus et al., 1998; Marcus et al., 1999; Katz et al., 2004)

Another study reported that abdominal muscle activity was increased due to diaphragm motion in response to different head-neck angles (Goldman et al., 1987). This shows the importance of understanding and optimizing the entire body position to decrease hazards. Some of our data agrees with this assessment, as we found that for the supine stroller condition, that infants experienced both increased head-neck flexion and increased abdominal muscle activity. Head-neck flexion also makes it easier for the airway to close. Researchers measured the pressures required to close infant's airways at controlled head-neck flexion angles, and found that the more flexion the head-neck segment experiences, the easier it is for the airway to close (Stark and Thatch, 1976).

Trunk flexion relates to conformity and/or concavity of the product in the longitudinal direction. Our research showed that seated products (swing, bouncer, and rocker) increased infants' trunk flexion between 23° and 27° on average compared to a firm flat surface. Previous research on both adults and infants shows that breathing is significantly negatively influenced by trunk flexion. In a study of 5 children (ages 3, 4, 4, 5, 8, and 33 months), respiration outcomes of static and dynamic respiratory system compliance and tidal volumes were measured during supine lying and in extreme truncal flexion while under anesthesia for unrelated purposes. For the 4 infants in the study, the dynamic respiratory system compliance decreased by a mean of 32%, peak pressure increased by 23%, and tidal volume decreased by 21% in the truncal flexion condition compared to supine lying. "Under normal conditions inspiration is associated with an outward displacement of the anterior abdominal wall, facilitating descent of the diaphragm. With extreme truncal flexion the abdominal contents are likely to be pushed up into the thoracic cavity resulting in cephalad displacement of the diaphragm. Also, expansion of the rib cage may be limited due to splinting of the chest wall by the extreme truncal flexion." (Sly et al., 1991). Decreased lung compliance increases the work of breathing.

Adult research has shown that a slouched position or higher trunk flexion can significantly decrease lung capacity and expiratory flow compared to a normal sitting position (Lin et al., 2006) and that long spinal flexion, mimicking a slumped posture, affects rib cage structure and chest wall motion during breathing compared to a normal sitting position (Lee et al., 2010). Although these studies were conducted on adults, it is safe to interpret our data on infants with more vulnerable and less robust respiratory systems in the same way. Thus, an infant's ability to breathe will be negatively impacted in products where a higher trunk flexion is exhibited, especially over prolonged periods of time. In the study we conducted as part of this research, infants were placed in the products in the intended position without the restraint. Even though each infant was placed as intended, the range of flexion angles in our

kinematic data was quite large, indicating that there are many factors that influence the positioning in each product.

Torso-pelvis flexion relates to seat design of the product and is changed based on the included angle of the product. A flatter product results in lower torso-pelvis flexion whereas a more defined seat with a larger included angle results in larger torso-pelvis flexion, based on the positioning of the pelvis in the product. Torso-pelvis flexion is a large part of infant roll initiation specifically for maneuvers that utilize fetal tuck mechanisms (Adler et al., 2007; McGraw, 1941; Kobayashi et al., 2016; Voss et al., 1985). Previous research shows that within inclined products, it is easier for infants to achieve some types of rolling from supine to prone due to the innate body position of the infant within the product (Wang et al., 2021). This is concerning because the suffocation risk increases substantially if infants do achieve a prone position in the products. Research looking specifically at how rolling techniques were altered at varying inclined mechanical environment found that infants utilize significantly different rolling techniques at higher included angles compared to the flat surface (Siegel et al., 2022) and that their muscle utilization patterns change with these movements as well (Siegel et al., 2023). When infants have higher initial torso-pelvis flexion and hip flexion when lying supine in a seated product, less coordinated movements are required to now initiate the roll. Thus, products that result in significantly higher torso-pelvis flexion compared to the flat surface—like the infant carrier, rocker, and swing—may facilitate rolling within the product, which puts infants at a greater risk of suffocation. Some of the IDIs we reviewed as part of this study described very young infants being placed in a supine position and found in a prone position within seated products, which supports the idea that the design of seated and inclined products facilitates some types of rolling for some infants.

Seat designs have previously been shown to influence oxygen saturation in newborns compared to a flat lying condition (Nagase et al., 2002). In a study on 15 infants, a chair-shaped car seat resulted in more episodes of mild desaturation ( $\text{SpO}_2 < 95\%$  for  $>10$  seconds) and moderate desaturation ( $\text{SpO}_2 < 90\%$  for  $>10$  seconds) over a 30-minute data collection period compared to a bed-shaped car seat. None of the infants in our study experienced moderate desaturation in any conditions, though we note the limitations with our  $\text{SpO}_2$  monitor and the limited data collection time.

Muscle activity. The bouncer, stroller, and swing resulted in significantly higher abdominal muscle activations, up to 240% for older infants compared to the playmat in the supine position. The same was not true for younger infants, where abdominal muscle activity was not different. Interestingly,

the most upright product, the infant floor seat, resulted in all infants using significantly less abdominal muscle activity, which is surprising considering that the unassisted sitting posture requires significant core strength for an infant. This means that infants are relying on the product to maintain the sitting posture, and the muscles they are using to sit are not equivalent to those that would be used in an unassisted sitting posture. This is reminiscent of research related to infant walkers which allow infants to “walk” assisted prior to obtaining the walking milestone unassisted. Researchers showed that use of infant walkers actually delayed the walking milestone compared to infants who did not use walkers (Siegel et al., 1999). Our results suggest the same may be true of infant sitting devices because the muscle coordination that infants require to sit while assisted in an infant floor seat are not equivalent to the coordination for unassisted sitting.

Previous research from our lab has shown a relationship between an increasing incline angle of a crib mattress and increased abdominal muscle activity and decreased erector spinae muscle activity during prone lying (Wang et al., 2020). We performed a simple correlation analysis on the mean muscle activity of the two muscle groups (abdominals and erector spinae) compared to the back incline angle of the seated product devices as measured by the infant hinged weight gauge. We found that during supine lying, there is a moderate negative correlation ( $r = -0.655$ ) between decreased erector spinae muscle activity and back incline angle, with 42.9% of the variation in erector spinae muscle activity explained by back incline angle alone. This was surprising but is most likely explained by the lack of movement of infants in the seated products, and the fact that the design of the products featured concavity and conformity which placed infants in a flexed trunk position during intended placement. No correlations were found for the abdominal muscles during supine lying. We note, however, that there are few data points in this correlation as we were restricted to including data from products which infants were tested within.

Quadriceps muscle activity was increased for older infants in the bouncer, stroller, and swing conditions, while this same trend was not present for the younger infants. Older infants were able to contact the seat portion of the products with their feet, which provided a surface that they could press against to activate their quadriceps muscles.

Considerations for unattended sleep. In normal older children and adults, the chest and abdomen expand synchronously, while in infants, the rib cage tends to collapse or move inward during inspiration, or paradoxical inward rib cage motion (PIRCM), when the diaphragm contracts (Kohyama et al., 200; Henderson-Smart and Read, 1976; Knill et al., 1976; Henderson-Smart and Read, 1979). Due to



lower chest wall muscle tone and increased chest wall compliance, PIRCM is increased during REM sleep. Even in full-term infants, REM sleep is associated with PIRCM and lower, more variable measures of partial pressure of oxygen ( $PO_2$ ) (Martin et al., 1979). In healthy, full-term infants, lung volume was 31% less in REM compared to NREM lung volume (Davis et al., 1988). This has very important clinical implications as it markedly increases the probability of oxygen desaturation; even with brief breathing interruptions, the proportion of REM is high in infants, and infants have high oxygen consumption and metabolic rate relative to body size, such that oxygen stores in the lungs are depleted faster when breathing is interrupted (Cherniack and Longobardo, 1970).

End-expiratory lung volume is important in infants because the lungs are the main reservoir of oxygen that buffer  $PO_2$  as breathing varies over time. Infants maintain end-expiratory lung volume above passive resting lung volume, which is important for stabilizing  $SpO_2$ . This indicates that preterm and full-term infants compensate for the “mechanical disadvantage” of their highly compliant chest wall by actively maintaining an elevated end-expiratory lung volume, although their ability to do this is substantially less in REM sleep, making them more vulnerable to any cause of respiratory compromise during REM sleep. Similarly, during the ventilatory response to  $CO_2$ , healthy preterm infants showed that abdominal muscles were recruited during NREM sleep and abdominal muscle recruitment was inhibited during REM sleep, contributing to the decreased ventilatory response to  $CO_2$  in REM sleep (Praud et al., 1991).

Importantly, REM sleep accounts for 50-60% of the total sleep time in term infants compared to 30% in adults, and it may comprise up to 90% in premature infants born at 30-32 weeks of gestation (Katz et al., 2012). Other researchers have shown that infants spend more time in REM sleep when they are first born, and REM sleep time decreases as they age (Haddad et al., 1981; Parmelee et al., 1967). This means that if infants fall asleep in these products, their breathing capabilities could be further reduced as they experience REM sleep more frequently than adults or older children.

A multitude of studies have reported a higher incidence of obstructive airway events in otherwise normal infants during REM sleep (Don et al., 2000; Hoppenbrouwers et al., 1993; Kahn et al., 1982; Pereira et al., 2008), but some have not (Orr et al., 1985). REM sleep is associated with hypotonia of the chest wall and upper airway muscles, lower lung volumes, paroxysmal reductions in pharyngeal tone, and increased respiratory variability. Also, compensation for increased nasal resistance is less robust during REM sleep (Purcell, 1976). Because of this, both obstructive events and hypoxemia tend to occur during REM sleep. Since infants spend more time in REM sleep compared to adults or older

children, they are at a higher risk of suffocation events occurring. Combined with products that may inhibit an infant's breathing ability or cause nasal occlusion, the risk is once again increased.

At sleep onset there is a reduction in airway and respiratory muscle activity. As sleep progresses, there is a gradual recruitment of upper airway dilator muscles and increased respiratory drive. Stable breathing is intermittently achieved, provided that the increase in respiratory drive, hypercapnia, and negative luminal pressure remain below an infant's arousal threshold (Katz et al., 2012). If breathing is already made more difficult due to alterations in body position because of the seated product design, the intermittent breathing patterns could become fatal very quickly. When infants fall asleep, even for short periods like napping, they are able to achieve REM sleep almost immediately where as in adults, REM is not achieved for around 90 minutes (El Shakankiry, 2011). Due to rapid achievement of REM sleep and the reduction in airway and respiratory muscle activity during sleep onset, breathing patterns can become unstable during shorter sleep periods when infants are placed in seated products, even during nap time.

Several researchers have found potential risk factors that either decrease the arousal response or increase the work required to breathe. In particular, sleep deprivation, potentially arising from viral infections, obstructive sleep apnea, or other sleep problems, is a risk factor for SIDS, as sleep deprivation may act by adversely affecting ventilatory control mechanisms, arousal threshold, and airway neuromuscular tone (Franco et al., 2004; McNamara and Sullivan, 2000;). Sleep deprivation and infection can also increase the arousal threshold (Abreu e Silva et al., 1985; Franco et al., 2004; Horne et al., 2002; Montemitro et al., 2008; Ward et al., 1992; Whitehead et al., 2018), meaning infants may not exhibit an arousal response in these scenarios.

Our study indicated that infants experience increased trunk flexion in seated products, which most likely indicates an increase in intraabdominal pressure – a factor known to elevate the work of breathing (Fok et al., 1997; Pelosi et al., 2007). The older infants ( $\geq 4$  months) in our study experienced an increase in abdominal muscle activity, which may be indicative of them compensating for the increased work of breathing, though the younger infants ( $< 4$  months) did not show this same increase. It is possible that the older infants had the motor skills and strength to overcome an increased work of breathing due to body position, while the younger infants did not.

Considerations for use during supervised awake time. The intended use of many seated products is for the infant to be buckled with the restraints provided, with some products specifically stating to use only under supervision. However, the IDIs we reviewed revealed that many infants are not restrained properly in seated devices, increasing their risk to end up in an unintended position, especially if they are left unsupervised. In our study, some infants exhibited a slouched posture in the products and others attempted to roll or crawl, which could be due to in part that we did not use the restraint provided on the devices. However, in our previous research (Mannen et al., 2019), we reviewed IDIs where infants were restrained in inclined products but still achieved a roll or other movements.

Offering infants a variety of body positions and opportunities to move in different ways throughout the day is beneficial to avoid gross motor milestone delays, head molding, shoulder retraction, and torticollis (Jones, 2004; Siegel et al., 1999). Furthermore, research on institutionalized infants shows that social-emotional deprivation, which includes a lack of infant-caregiver interaction and visual stimulation, can significantly delay infant development (McCall et al., 2019). Institutionalized infants also experience a higher risk of motor developmental delays (Roeber et al., 2012), and this deprivation in social and environmental conditions may manifest as psychiatric disorders later in life (McLaughlin et al., 2010). Seated infant products do offer infants a different visual perspective and body position compared to supine lying, which could be beneficial as a unique opportunity for learning and social interaction during awake time for infants who would otherwise be lying in a crib all day, like some institutionalized infants (Frankchak, 2019).

In our human subjects study, the older infants ( $\geq 4$  months) were activating their muscles more than younger infants ( $<4$  months) during supine lying within the seated products. This suggests that products used by infants above a certain age threshold may be beneficial and encourage muscle use. However, if an older infant falls asleep in a seated product, the infant should be removed and placed into a crib or bassinet. In turn, younger infants may experience greater risk while using seated products even during supervised awake time because our study indicates that younger infants are not using their muscles (either to maintain posture in these products and/or overcome an increased work of breathing), meaning that the shape of the product is the main contributor to the body position of the infants. This means that younger infants may not be able to move from a position that inhibits their breathing in the same way that older infants can intentionally move their bodies. In our study, the seated products resulted in both head-neck flexion and trunk flexion – body positions which can inhibit normal

breathing. If younger infants experience an increased work of breathing due to the compromised body position, they may not have the motor control or muscle strength to move into a more favorable position.

Considerations for Infant Rolling. Our previous research on inclined sleep products which feature a seat with back incline angles from 9° to 31° supported the idea that the body position and muscle activity that infants use within inclined sleep products can facilitate a roll, sometimes before an infant can roll on a flat surface due to the differing mechanical environment (Wang et al., 2021). Similarly, a recent study in our lab found that infants have significantly different muscle activations (lower abdominal and higher erector spinae) during supine to prone rolling in different inclined environments featuring 10°, 18°, and 28° seatback angles compared to a firm flat surface (Siegel et al., 2023), and that infants sometimes use different coordinated movements to roll within the inclined mechanical environments compared to a firm flat surface (Siegel et al., 2022). An infant's ability to roll and the muscle activations used during rolling should also be considered for seated products. All seated products we tested as part of the *in vivo* human subjects collection resulted in a significant difference in abdominal and/or erector spinae muscle activation of infants while supine lying during a 60 second awake period. This change in muscle coordination while lying translates to rolling maneuvers in these products, meaning that some products may facilitate rolling before an infant can achieve the same movement on a firm flat surface. We note that our research did not include restrained infants. In a scenario where an infant is properly restrained within a seated product, the chance of rolling within the product would likely decrease but would not be impossible. However, as the IDIs in this research and our previous work on inclined sleep products indicate (Mannen et al., 2019), caregivers foreseeably use infant seated products without restraining their infants.

#### 8.4.2 Prone Lying

Previous researchers have reported that infants who are inexperienced in prone positioning (i.e. younger infants) have a decreased ability to avoid suffocation (Côté et al., 2000; Moon et al., 2022; Paluszynska et al., 2004). This means that younger infants are at a higher risk for suffocation in the prone position, especially for products that require different muscle activation levels compared to the flat surface, like we found in the bouncer, infant carrier, rocker, and swing. When interpreting these results in conjunction with physiological features such as lower ratio of sub cortical to cortical arousal (Richardson et al. 2008), lower ventilatory response to inhaled CO<sub>2</sub> (Smith et al., 2010), and lower blood pressure and higher heart rate (Yiallourou et al., 2008), seated products that require more muscle activation during prone positioning (like the abdominal muscles in our study) may fatigue infants more quickly, leading to a hazardous situation.

Mouth/nose Interactions. Spontaneous mouth breathing during sleep is uncommon in infants and nasal breathing remains the preferred method (Miller et al., 1985). When infants experience nasal occlusion challenges, only 40% of infants switch from nasal breathing to mouth breathing which is triggered by arousal, oxygen desaturation, grunting, and sighs (Lijowska et al., 1997; Miller et al, 1985; Wulbrand et al., 1985). During REM sleep, switching from nasal breathing to mouth breathing is even less effective (Swift et al., 1973; Purcell, 1976). Therefore, nasal occlusion is of primary concern for prevention, while mouth occlusion is less hazardous. This means that seated products that occlude the nose but leave the mouth fully or partially covered would still present a suffocation risk.

Our results indicate that in all seated products tested in a prone position (infant carrier, bouncer, rocker, and swing), participants spent significantly more time with their face in contact with the product compared to the playmat. The swing had the most time spent in contact at nearly 65% of the trial on average. This was especially true for older infants as the swing tended to be inverted, forcing the infant's face to be in contact with the product, where if left unattended, creates a suffocation risk. In addition, during prone lying the cervical paraspinal muscle activity was significantly lower for the infant carrier, bouncer, and swing. This indicates that some infants are not holding their heads up at all and are instead resting their face in the product during the entire collection. Infants around 2 months of age also have a very low muscle function score (Ohman and Beckung, 2008), meaning they have little head-neck control and muscle strength, which further increases the likelihood of the nose or mouth of younger infants to be in contact with the seated products in the prone position.

Abdominal muscle activity was significantly higher in the prone position for the infant carrier, bouncer, and rocker compared to the playmat. This is consistent with previous findings of prone lying at different inclines and within inclined sleep products, where there was a significant increase of core muscle activations as the incline angle increased (Wang et al., 2020; Wang et al., 2021). This indicates that muscle fatigue of the abdominal muscles could occur more quickly in inclined products where the abdominal muscle activation is significantly higher, resulting in an increased risk of suffocation when infants are in the prone position if they cannot maneuver into a position to breathe freely.

To better understand how product design, specifically back incline angle alone, influences muscle activity during prone lying, we performed a simple correlation analysis on the mean muscle activity of the two muscle groups (abdominals and erector spinae) compared to the back incline angle of the seated product devices as measured by the infant hinged weight gauge. The erector spinae muscles had a high negative correlation with the back incline angle ( $r = -0.868$ ), meaning that as the back incline angle increased, the erector spinae muscle activity decreased. The variation could be explained by the back incline angle alone 75.4% of the time. Conversely, the abdominal muscles had a moderate positive correlation with the back incline angle of the products ( $r = 0.547$ ), meaning that as the back incline angle increased, so did the abdominal muscle activity. The variation could be explained by the back incline angle alone 30.0% of the time. These results agree with our previous research, indicating that inclined surfaces, and in this case inclined seated products, influence the muscle activity of the abdominals and erector spinae muscle groups during prone lying.

Previous studies have also demonstrated the role of abdominal muscles during breathing, though not in different seated products. Abdominal muscles stabilize the chest wall and push up on the abdominal contents, which are partially incompressible. Diaphragm contraction elevates and expands the lower rib cage in addition to lowering intrathoracic pressure (Panitch, 2015). Thus, abdominal muscle activity may be closely related with changes in intra-abdominal pressure and diaphragm function (Cresswell et al., 1992; Lopes et al., 1981). Abdominal muscles are also expiratory accessory muscles that aid in forced exhalation against obstructed airways (Bishop, 1963; Goldman et al., 1987).

The infant carrier, bouncer, and rocker resulted in significantly higher abdominal muscle activation of up to 225% compared to the playmat in the prone position, and therefore an infant's ability to breathe normally may be affected by these products. Contraction of the abdominal muscles leads to decreased lung volume and hypoxic episodes (Bolivar et al., 1995; Esquer et al., 2008, 2007), so it is possible that products that require higher abdominal muscle activation could restrict rib cage expansion

and lower lung volumes, increasing the risk of positional asphyxiation events. Furthermore, the respiratory muscles of infants are immature and prone to fatigue (Watchko et al., 1991), exacerbating the hazard if infants are prone in seated products.



### 8.4.3 Other Considerations

Infant floor seats and strollers are the most different from the other products in this seated product study. Infant floor seats put infants in a fully upright seated position, while some strollers also feature more upright postures. These two product categories have their own challenges, and more testing should be done to better understand body position within these devices since much of our motion capture and sagittal plane testing data was not applicable to these product categories.

Infants with neuromuscular weakness may have impaired motor control of upper airway dilators (Katz et al., 2012). Infants that already have a developmental or motor delay are at more risk of impaired breathing, and if placed in seated product with less than ideal positioning, this could increase the risk for breathing complications.

A variety of positions and opportunities for infants to be placed in different positions and to move in different ways is beneficial to avoid gross motor milestone delays, head molding, shoulder retraction, and torticollis. Seated products offer some variety of body position for infants, and during supervised use, could provide benefits to older infants with more developed musculoskeletal systems and strength, particularly for infants who may otherwise be lying in a crib all day.

While in vivo biomechanics studies offer robust data related to risks that event may occur, there are known limitations inherent in laboratory testing, especially with infants. We were limited in the number of test conditions that infants can complete and thus could not test all 24 seated products. Our population was not as racially nor ethnically diverse as the United States, and instead represented the demographical makeup of the Boise, Idaho, metropolitan area (87% white/Caucasian; 9% Hispanic/Latino; 4% other; U.S. Census Bureau, 2022). Anatomical landmarks on infants can be challenging to palpate, and infants cannot perform maximum voluntary muscle contractions which are sometimes used to normalize EMG data. We overcame these challenges by normalizing each infant's data to their own supine and prone flat surface trials. Our study was powered such that we required 9 complete data sets in each testing condition, which we achieved. Our initial study design did not include comparisons between younger and older infants, so these statistical comparisons were underpowered. Yet, we still found statistical significance in some younger vs. older comparisons. Future studies should focus more on the biomechanical differences between younger and older infants within infant products.

Finally, the benefits of seated products for caregivers are not ignored. We recognize that caregivers need a place to safely put an infant, which under some circumstances, seated products may

offer a safer place than other alternatives. Our IDI review elucidated that many parents used seated products for just that purpose – because they believed it to be a safer space for their infants compared to the environment. However, this was not the focus of our analysis.

## 8.5 In vivo Human Subjects Testing Summary

During supine lying in seated products, infants experienced increased head-neck flexion and trunk flexion compared to lying on a firm flat surface. Both head-neck flexion and trunk flexion can inhibit normal breathing, which can lead to an increased work of breathing. Infants, especially younger infants, may lack the motor control or muscle strength to overcome the increased work of breathing or may not be able move to a position which is more favorable to facilitate normal breathing. Older infants used their abdominal muscles and quadriceps muscles significantly more in the bouncer, stroller, and swing conditions than they did on a firm flat surface, while this same trend was not present for the younger infants. The higher muscle activity could benefit older infants when they are awake and attended, especially those infants who would otherwise be lying in a crib all day.

During prone lying in seated products, infants' faces were in contact with the surface of the seated product over twice as much compared to prone lying on the firm flat playmat. The infant carrier, bouncer, and rocker resulted in significantly higher abdominal muscle activation of up to 225% compared to the playmat in the prone position. An infant's ability to breathe normally in a prone position is likely affected by seated products. If an infant is not found by a caregiver or cannot move their mouth/nose into position which enables free airflow, their risk of suffocation increases.

## 9. Sagittal Plane Testing

### 9.1 Sagittal Plane Testing Overview

Our human subjects data from this study (section 8) and from our previous study (Wang et al., 2021) reveals that sagittal plane body position of infants is influenced by product design and the mechanical environment which infants are within. As discussed in section 8, body position (both head-neck flexion and trunk flexion) can negatively influence respiration and intraabdominal pressure. Thus, there is a need to quantify the body position of an infant lying within seated products, but a robust *in vivo* biomechanics study is not a feasible method of evaluating body position for every single seated product. Thus, a testing device that can be easily manufactured and used that is validated with human subjects data would provide valuable information to designers and manufacturers.

Currently, there exists a standard testing device referred to as a hinged weight gauge that can estimate the back incline angle and included angle of an infant seated product (ASTM F3118-17a Standard Consumer Safety Specification for Infant Inclined Sleep Products). While this device may be relevant to estimate the seatback incline angle of sufficiently firm products, it does not accurately estimate the body position of infants within the products. The hinged weight gauge device must be improved to further examine the positional asphyxiation risk posed by these same products, particularly in the context of head-neck flexion or extension angle, and trunk flexion.

We previously developed an anthropometrically based 4-segment sagittal plane device which was used to better understand the body position of infants lying on pillow products (Mannen et al., 2022). While the 4-segment device improved upon the 2-segment hinged weight gauge, there was still no pelvis segment which made positioning within the seated products for the project difficult. Furthermore, there was no human subjects data with which to compare the data from the 4-segment device.

For these reasons, we improved upon the 4-segment device by creating an anthropometrically based five-segment device which features a pelvis segment, and then compared the data from the various sagittal plane devices to the results of our human subjects testing from section 8.

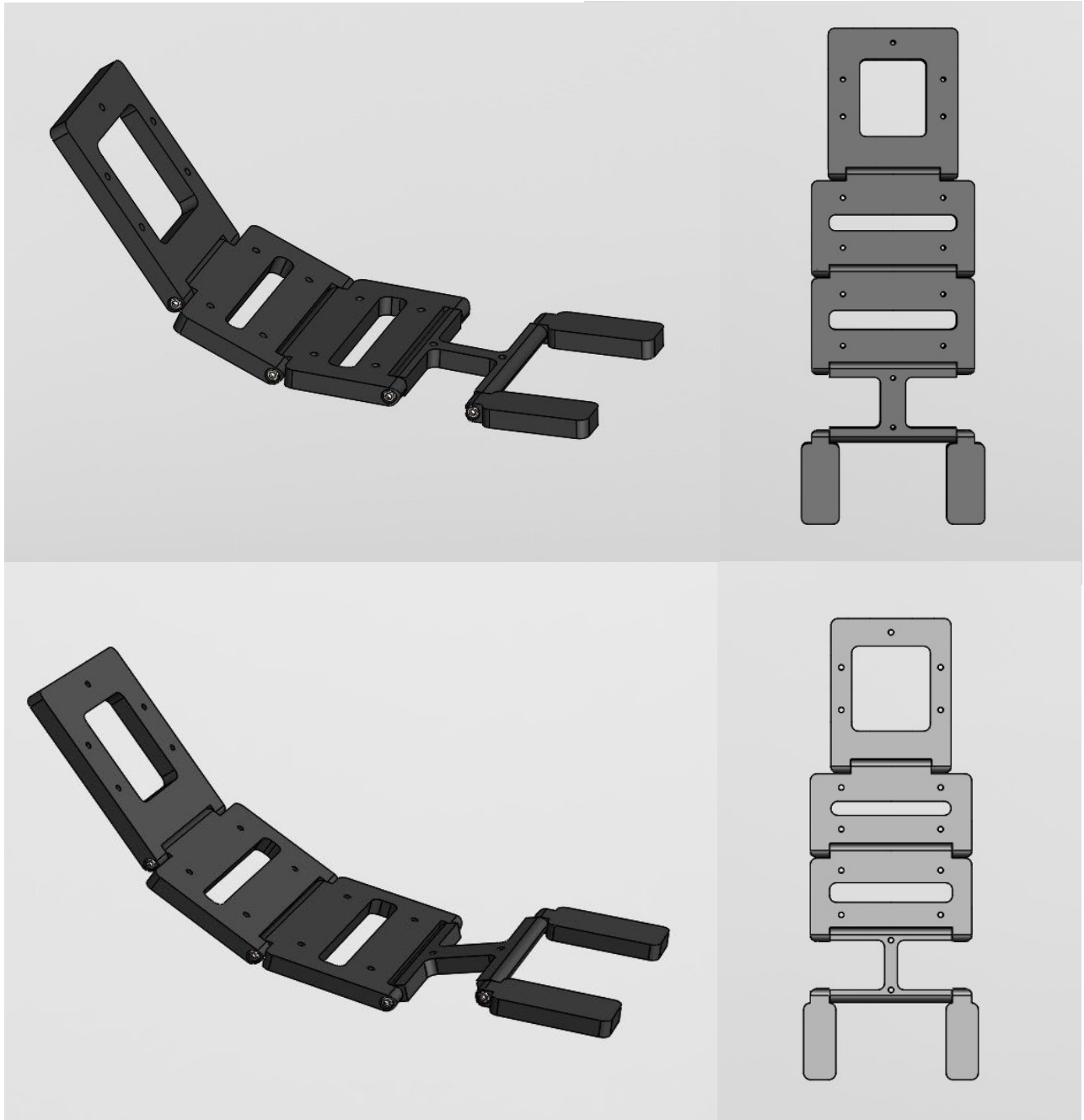
## 9.2 Sagittal Plane Testing Methods

We developed two anthropometry-based devices similar to the 4-segment model that allowed us to measure head-neck flexion, trunk flexion, torso-pelvis, and hip flexion angles. Two models were developed for two age groups: newborn and infant (3 month-old). Because some of the products we tested are intended only for younger infants and because SIDS deaths are most common in the 2 to 4 month age range (Duncan and Byard, 2018; Goldberg et al., 1986; Mage and Donner, 2009), we chose a 3 month old for the size of our infant model. The anthropometric data is summarized in **Table 19**. Each segment was fitted by length and weight in accordance with how typical males and females should develop by the World Health Organization (WHO) growth charts (Centers for Disease Control and Prevention, 2001).

**Table 23.** Anthropometric newborn and infant (3 month old) measurements for five segment sagittal plane devices.

Segment	Newborn		Infant	
	Length (cm)	Weight (kg)	Length (cm)	Weight (kg)
<i>Head</i>	13.6	0.90	15.0	1.33
<i>Upper Torso</i>	7.7	0.92	10.0	1.36
<i>Lower Torso</i>	7.7	0.92	10.0	1.36
<i>Pelvis</i>	5.6	0.28	7.0	0.49
<i>Legs</i>	7.8	0.45	9.0	0.63
<i>Width of All</i>	14.9	N/A	16.5	N/A
<i>Min. Width</i>	13.4	N/A	14.9	N/A
<i>Max. Width</i>	16.3	N/A	18.2	N/A
<i>Min. Pelvis Width</i>	9.5	N/A	10.2	N/A
<i>Head Width</i>	11.1	N/A	13.1	N/A

Each body segment (head, upper torso, lower torso, pelvis, and legs) was designed as a rectangular prism with cutouts to mimic the segmental weight and center of gravity of infants. The pelvis segment was added to improve seating position consistency for testing. Three-dimensional renderings are shown in **Figure 93**, while engineering drawings for the newborn (**Figure 94**) and infant (**Figure 95**) devices are also provided. We had a professional machine shop machine these devices with a Cerakote thin film ceramic coating used to prevent corrosion on the mild steel, costing a total of \$1,975 each. Because a goal for these types of devices is eventual implementation into a testing standard, it is important to keep the costs as low as possible while also providing meaningful results.



**Figure 221.** Three-dimensional renderings of the (Top) newborn-sized five segment sagittal plane device, and (Bottom) infant-sized (three-month old) five segment sagittal plane device.

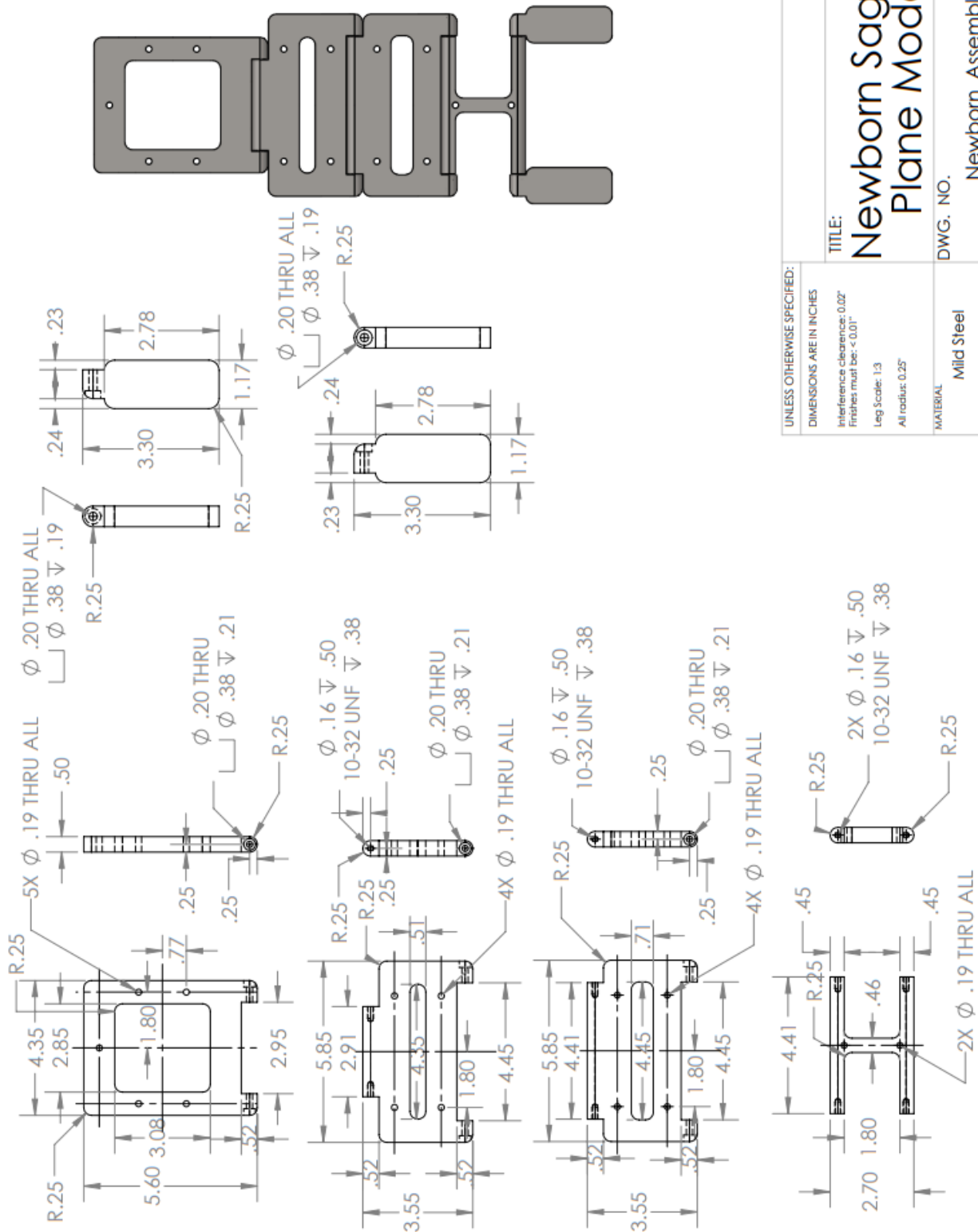
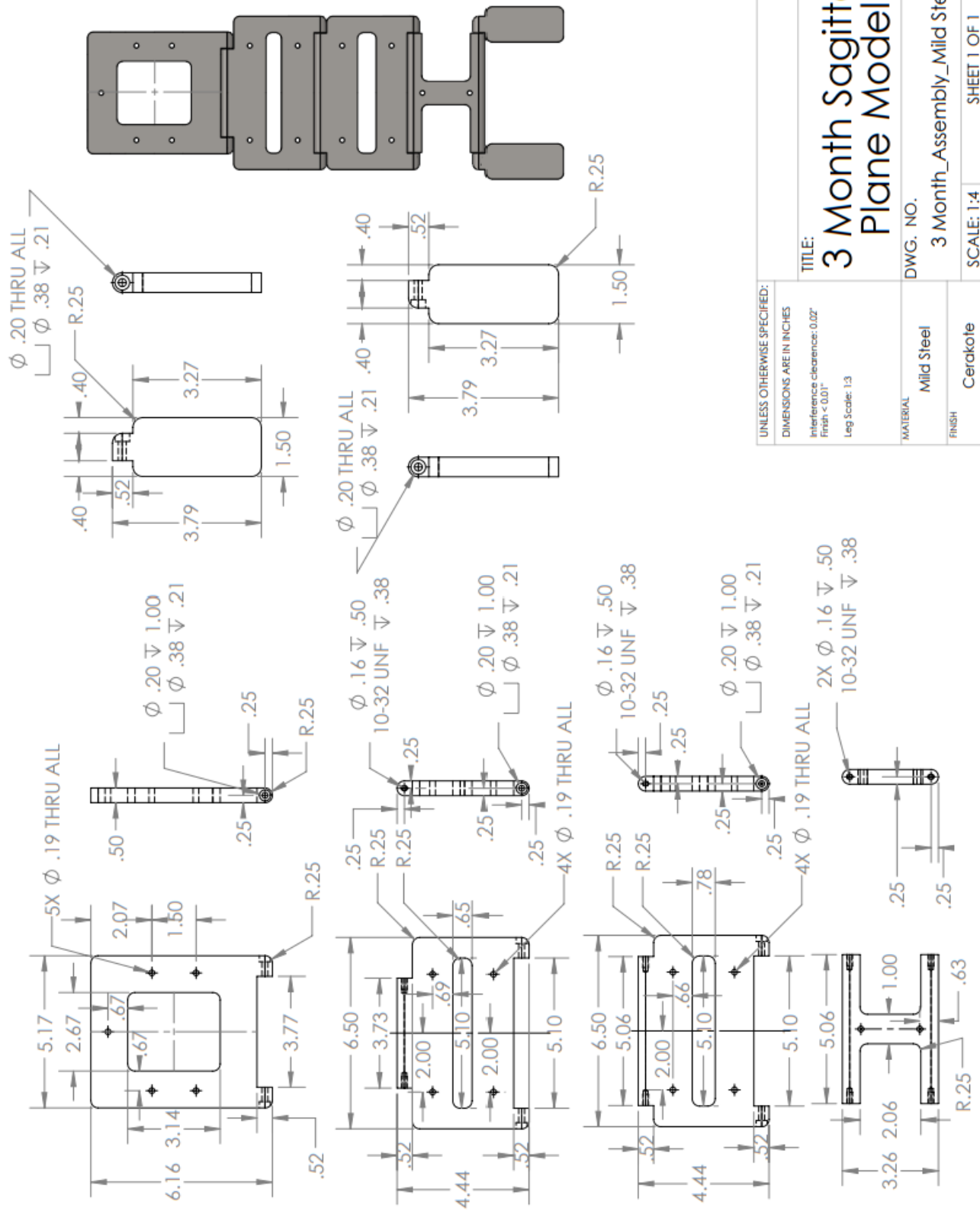


Figure 222. Newborn-sized five-segment sagittal plane device assembly drawing.

UNLESS OTHERWISE SPECIFIED:	
DIMENSIONS ARE IN INCHES	
Interference clearance: 0.02"	
Finishes must be: < 0.01"	
Leg Scale: 1:3	
All radius: 0.25"	
MATERIAL	Mild Steel
FINISH	Cerakote
TITLE:	Newborn Sagittal Plane Model
DWG. NO.	Newborn_Assembly
SCALE: 1:4	SHEET 1 OF 1

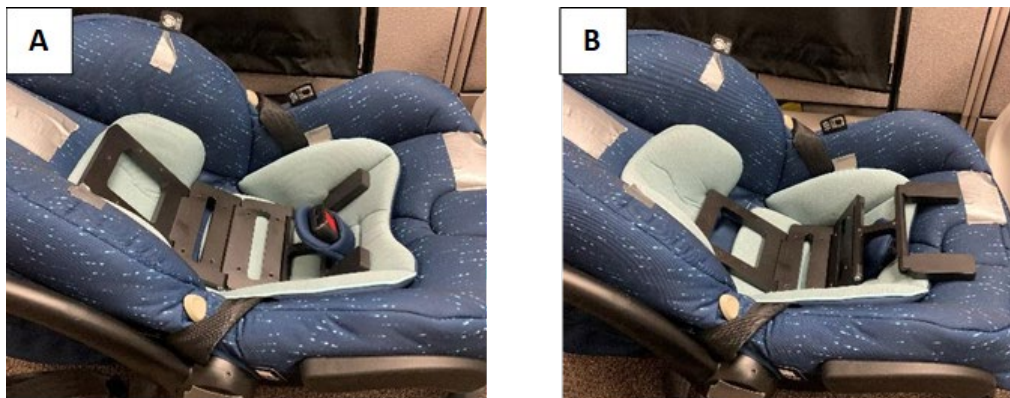




UNLESS OTHERWISE SPECIFIED:		TITLE:	
DIMENSIONS ARE IN INCHES		<b>3 Month Sagittal Plane Model</b>	
Interference clearance: 0.02"		DWG. NO.	
Finish < 0.01"		3 Month_Assembly_Mild Steel	
Leg Scale: 1:3		SCALE: 1:4	
MATERIAL		FINISH	
Mild Steel		Cerakote	
SHEET 1 OF 1			

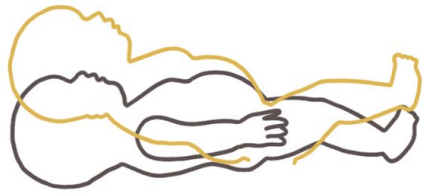
**Figure 223.** Infant-sized (3 month old) five-segment sagittal plane device assembly drawing.

Each five-segment sagittal plane device was placed in the intended position and a slouched position (represented in this case by moving the pelvis segment past the intended position) in all 24 products. For the intended positioning, the pelvis segment was placed above the seam of the harness, while the slouched position was meant to mimic a child who has slid by their own accord and/or with gravity into a slouched position with their pelvis placed past the harness (**Figure 96**). The cutout of the lower torso was placed where the pelvis segment was positioned in the intended position so that the device is in a slouched position with the legs positioned closer to the end of the seated product. The angle of each segment compared to a flat surface was recorded using a Wixey Digital Angle Gauge (WR300 Type 2; accuracy of 0.1°). The inclinometer was zeroed on the testing surface and each segment angle was measured for a total of three times.



**Figure 224.** Example positioning of the five segment sagittal plane device in infant carrier S06 in (A) the intended position, and (B) the slouched position.

Through a custom MATLAB code, the difference between each segment's angles was calculated to find the flexion or extension angles of the head-neck, trunk, torso-pelvis, and hip (**Figure 97**). On a firm flat surface, all angles between segments are considered to be 0°, so normalization to a flat surface condition was not necessary for this testing.



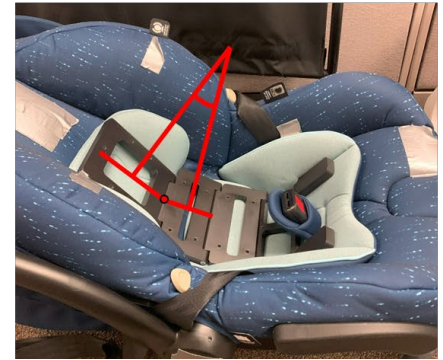
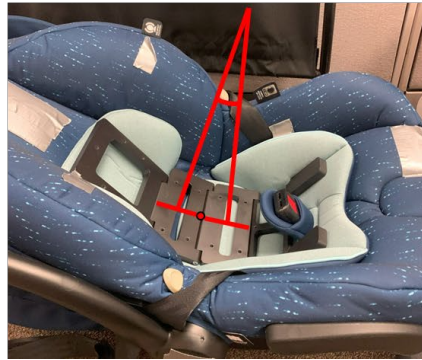
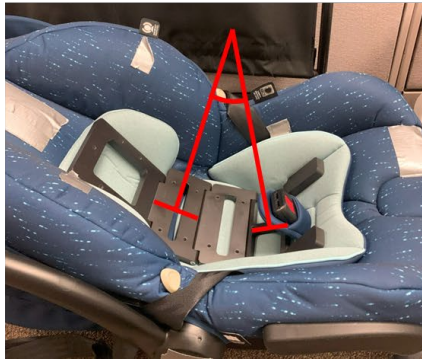
Torso-Pelvis Flexion



Trunk Flexion



Head-Neck Flexion



**Figure 225.** Example of torso-pelvis, trunk flexion, and head-neck flexion measured by the five-segment sagittal plane device in infant carrier S06. We also measured hip flexion as the angle between the pelvis and leg segments, though no corresponding human subjects data is available.

In addition to the segmental angles from the five-segment sagittal plane device, we compared the results from all infant sized sagittal plane devices (two segment hinged weight gauge, four segment sagittal plane device, and five segment sagittal plane device) as well as the head-neck angle measured with an infant-sized CAMI dummy (Chandler, 1974) which features a three-dimensional head shape to the actual human subjects means from the products included in the human subjects testing. The goal of these comparisons was to determine which device, if any, can accurately estimate the important sagittal plane kinematics of infants lying within seated products.

### 9.3 Sagittal Plane Testing Results

Sagittal plane testing with the five-segment device was completed for all products except the strollers. Due to the upright positioning of the floor seats, the nearly two-dimensional sagittal plane device did not lay flat against the infant floor seat products. The mean head-neck, torso, torso-pelvis, and hip flexion angles are presented for the newborn sized device in the intended position (**Table 20**), the newborn sized device in the slouched position (**Table 21**), the infant sized device in the intended position (**Table 22**), and the infant sized device in the slouched position (**Table 23**).

**Table 27.** Sagittal plane testing results for each product with the newborn sized device in the intended position.

Category	Sample	Head-Neck		Trunk		Torso - Pelvis		Lower Torso - Pelvis		Hip	
		Mean	St. Dev.	Mean	St. Dev.	Mean	St. Dev.	Mean	St. Dev.	Mean	St. Dev.
Car Seats	S05	1.4	2.5	57.3	2.0	84.4	2.7	27.1	4.7	-9.0	1.3
	S06	25.5	8.5	22.2	5.0	53.3	4.4	31.2	2.2	31.4	2.1
	S07	28.9	1.7	-9.8	2.0	46.5	6.9	56.3	6.4	8.3	11.5
	S08	26.7	5.9	19.5	3.8	20.5	4.5	1.0	1.1	31.6	1.5
Bouncers	S09	7.8	1.0	28.7	2.8	83.3	3.8	54.6	1.3	-37.6	6.5
	S10	26.1	3.7	0.5	3.7	14.3	3.2	13.8	5.6	39.8	10.3
	S11	13.9	1.3	31.1	1.6	59.0	1.1	27.8	0.5	14.9	0.7
	S12	17.3	2.1	7.6	2.3	16.9	1.7	9.3	3.6	12.7	17.9
Strollers	S13	10.1	2.5	-15.5	3.6	71.2	2.3	86.7	1.3	-11.7	0.3
	S14	40.8	2.6	-6.9	2.5	58.1	2.8	65.0	0.8	12.2	2.2
	S15	1.7	0.8	-0.8	1.8	32.0	0.6	32.8	1.3	9.8	1.5
	S16	10.1	5.3	-4.6	10.8	43.9	7.0	48.5	12.7	-1.2	7.9
Rockers	S17	9.7	1.3	2.7	1.1	14.7	1.8	12.0	1.1	36.8	0.5
	S18	11.1	1.3	17.6	2.1	27.7	1.5	10.1	1.2	13.4	6.5
	S19	5.1	4.4	14.9	6.8	82.2	4.8	67.3	11.6	-6.2	16.8
	S20	6.9	0.6	26.0	3.2	50.6	0.4	24.5	2.9	19.1	0.1
Swings	S21	14.0	4.0	-12.9	1.6	52.9	3.1	65.8	3.8	27.2	6.5
	S22	18.6	1.2	40.3	2.2	66.5	2.6	26.2	4.8	-15.1	21.8
	S23	25.7	5.2	46.4	2.1	69.6	3.4	23.1	1.3	4.2	0.5
	S24	18.7	3.0	26.6	2.2	49.1	2.0	22.5	0.3	10.0	0.7

**Table 36.** Sagittal plane testing results for each product with the newborn device in the slouched position.

Category	Sample	Head-Neck		Trunk		Torso - Pelvis		Lower Torso - Pelvis		Hip	
		Mean	St. Dev.	Mean	St. Dev.	Mean	St. Dev.	Mean	St. Dev.	Mean	St. Dev.
Infant Carriers	S05	60.9	3.6	32.7	4.5	38.2	7.5	-37.4	4.4	-54.8	10.6
	S06	44.7	1.2	47.7	1.4	39.8	13.1	-25.8	4.3	-38.1	8.6
	S07	11.8	2.0	60.1	2.3	49.3	2.1	-12.7	9.1	-18.0	2.8
	S08	6.4	10.8	57.7	15.6	27.8	5.5	-52.5	8.7	-55.3	15.7
Bouncers	S09	50.9	3.1	13.1	8.1	-59.0	8.7	20.3	4.5	15.8	4.0
	S10	16.5	2.6	38.1	2.4	36.5	0.6	-30.7	4.7	-37.1	3.3
	S11	37.2	2.4	32.1	3.1	54.6	4.8	-6.1	1.1	-26.7	5.4
	S12	16.2	3.7	18.6	3.1	67.1	5.9	-9.7	3.7	-13.5	10.2
Strollers	S13	38.6	4.9	34.3	5.6	24.0	8.7	8.4	0.9	-34.4	2.9
	S14	40.4	4.2	58.0	0.7	25.0	10.2	-25.3	3.0	-30.7	9.9
	S15	11.3	5.4	28.0	2.4	37.4	6.6	-3.9	2.5	-37.6	4.8
	S16	34.5	1.8	15.7	1.4	5.1	4.9	2.0	6.3	-49.9	2.2
Rockers	S17	-18.0	44.2	23.1	0.7	56.4	1.6	-7.5	2.1	3.4	1.7
	S18	21.2	2.8	15.8	2.5	34.7	4.2	-3.3	1.3	5.0	2.8
	S19	22.7	8.5	79.7	5.2	40.7	10.3	-14.0	11.6	-32.8	6.3
	S20	35.3	1.4	23.8	0.7	44.4	0.9	-2.5	1.0	-58.6	1.1
Swings	S21	14.2	3.4	74.6	0.8	58.3	8.0	-23.6	3.9	-18.8	3.2
	S22	60.4	1.5	8.9	1.1	12.1	4.1	2.2	4.1	-35.3	4.0
	S23	52.0	2.3	21.1	2.2	23.9	4.9	7.5	0.5	-21.9	2.9
	S24	32.7	0.4	28.1	0.1	43.0	0.4	5.3	0.9	-5.6	1.1

**Table 47.** Sagittal plane testing results for each product with the infant device in the intended position.

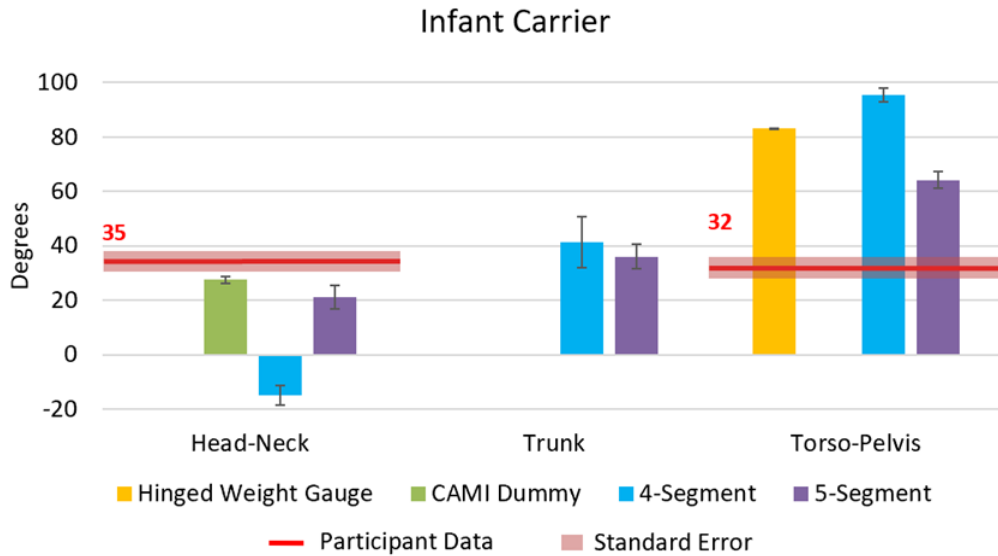
Category	Sample	Head-Neck		Trunk		Torso - Pelvis		Lower Torso - Pelvis		Hip	
		Mean	St. Dev.	Mean	St. Dev.	Mean	St. Dev.	Mean	St. Dev.	Mean	St. Dev.
Infant Carriers	S05	18.0	7.4	16.0	11.1	87.8	3.9	71.8	7.4	-19.7	0.3
	S06	21.2	4.4	35.9	4.5	64.1	3.0	28.2	3.6	34.9	3.1
	S07	23.8	1.0	16.6	1.1	18.7	4.2	2.1	4.9	53.4	9.1
	S08	10.8	5.2	33.1	2.3	43.3	2.3	10.1	1.2	30.7	1.1
Bouncers	S09	2.1	0.7	22.1	9.1	81.8	1.4	59.7	10.2	-26.9	25.4
	S10	26.4	1.9	15.4	1.3	27.1	2.3	11.7	3.2	38.2	2.9
	S11	-19.3	5.0	33.7	4.0	70.1	3.3	36.4	0.8	22.6	0.6
	S12	14.8	1.7	14.1	1.6	25.0	2.3	10.9	3.6	26.3	1.9
Strollers	S13	3.9	0.8	-2.0	1.6	74.7	1.3	76.6	0.4	-9.7	1.1
	S14	38.2	1.5	10.4	4.0	62.4	2.0	52.0	2.2	28.5	5.4
	S15	9.3	0.9	-7.1	0.6	27.7	0.2	34.9	0.5	12.3	0.9
	S16	-2.9	4.8	10.1	0.5	49.9	4.9	39.8	5.0	0.8	1.4
Rockers	S17	-0.4	0.5	8.9	0.3	14.2	1.1	5.3	1.2	44.2	0.4
	S18	13.1	0.8	13.8	0.5	32.4	1.1	18.7	1.5	17.4	1.9
	S19	29.9	5.6	-6.3	4.3	75.6	4.4	81.9	2.0	-14.5	8.2
	S20	5.9	0.3	17.5	0.3	53.0	3.3	35.6	3.6	22.0	5.6
Swings	S21	4.1	1.9	7.2	1.2	42.3	1.4	35.0	2.5	53.4	4.3
	S22	8.4	0.2	30.9	1.1	77.4	0.9	46.5	1.8	-4.9	1.6
	S23	19.7	5.6	47.4	1.3	87.6	3.4	40.2	2.6	2.2	1.3
	S24	-0.4	1.0	29.2	0.7	59.8	0.9	30.6	0.4	13.6	1.3

**Table 45.** Sagittal plane testing results for each product with the infant device in the slouched position.

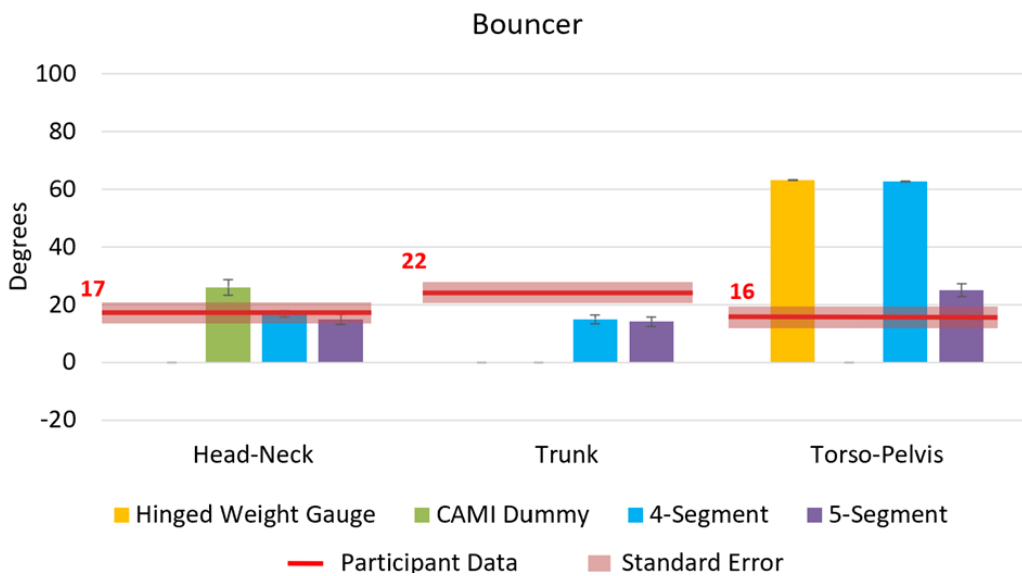
Category	Sample	Head-Neck		Trunk		Torso - Pelvis		Lower Torso - Pelvis		Hip	
		Mean	St. Dev.	Mean	St. Dev.	Mean	St. Dev.	Mean	St. Dev.	Mean	St. Dev.
Infant Carriers	S05	52.7	1.9	53.6	3.1	11.9	3.9	-6.4	2.3	-7.7	4.5
	S06	39.4	2.3	55.1	0.6	40.1	9.4	-22.6	3.2	-24.4	5.1
	S07	11.5	3.8	37.7	4.0	37.0	10.4	-23.6	4.2	22.6	14.1
	S08	25.5	9.5	44.5	6.6	53.0	7.0	-30.4	2.3	-68.5	21.3
Bouncers	S09	45.0	6.1	19.1	11.4	-48.7	9.4	22.6	5.7	-5.2	72.4
	S10	12.5	6.9	38.1	8.6	34.8	10.8	-23.0	7.5	-42.1	22.1
	S11	34.3	1.7	37.1	2.0	67.7	2.4	-4.1	2.1	-30.2	2.1
	S12	13.5	2.0	19.4	2.6	70.4	2.5	-2.3	8.0	-27.6	9.4
Strollers	S13	26.4	4.8	47.0	5.4	26.8	8.8	8.1	2.2	-46.5	0.6
	S14	20.0	8.4	72.0	6.8	83.3	13.8	-18.6	1.5	-72.6	3.5
	S15	3.3	4.1	35.4	0.7	29.6	10.4	-7.7	2.9	-57.1	4.8
	S16	9.7	3.2	38.3	3.7	24.8	8.1	1.0	2.7	-46.4	3.3
Rockers	S17	8.3	2.5	23.1	0.7	59.8	1.2	-6.9	1.9	2.3	0.2
	S18	18.2	0.6	18.1	0.2	40.5	0.5	2.9	0.9	10.4	1.1
	S19	10.4	10.6	77.7	7.8	40.2	9.0	1.0	2.8	-22.6	3.8
	S20	33.5	1.8	30.4	1.1	40.3	6.1	1.8	4.0	-40.7	3.7
Swings	S21	9.4	1.5	72.7	2.2	50.7	2.2	-38.5	0.2	-1.6	2.2
	S22	53.9	1.8	25.5	1.1	16.1	4.0	2.7	0.9	-41.9	0.6
	S23	52.1	1.0	32.2	0.2	27.8	2.3	14.0	2.0	-20.2	1.7
	S24	29.8	0.3	35.4	0.2	57.2	0.4	8.9	1.0	-32.5	1.4



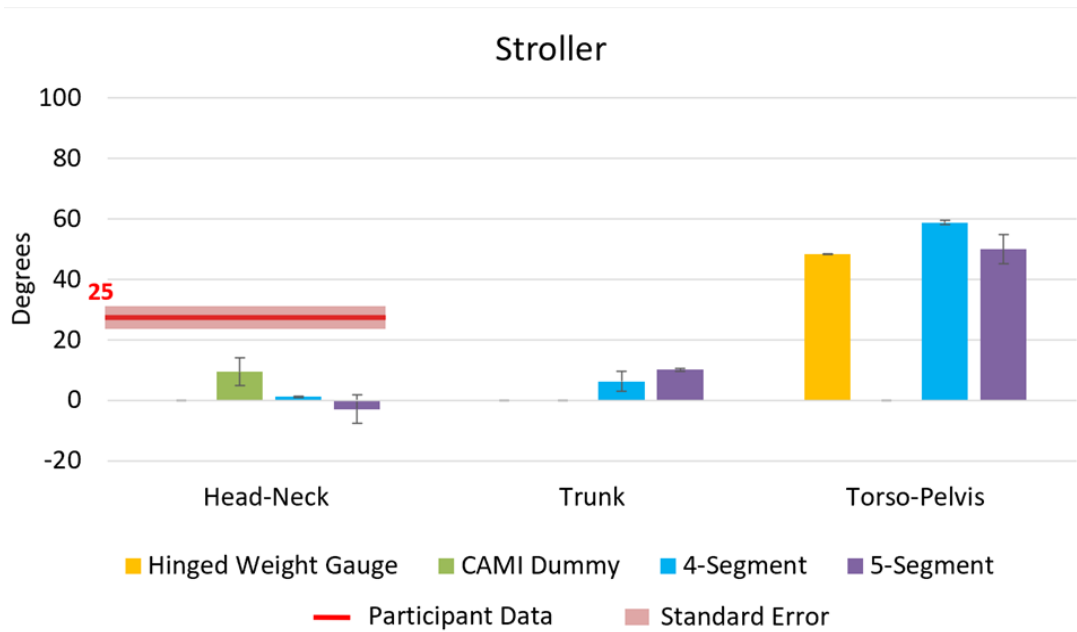
Comparisons of the various infant sized sagittal plane devices with the mean of the kinematic data from the human subjects study are presented for the infant carrier (**Figure 98**), bouncer (**Figure 99**), stroller (**Figure 100**), rocker (**Figure 101**), and swing (**Figure 102**). Not all data could be collected from each sagittal plane device or from the human subjects testing. Missing data is indicative of the inability of the sagittal plane device to measure that angle, and missing participant data means that the kinematics could not be collected within that product.



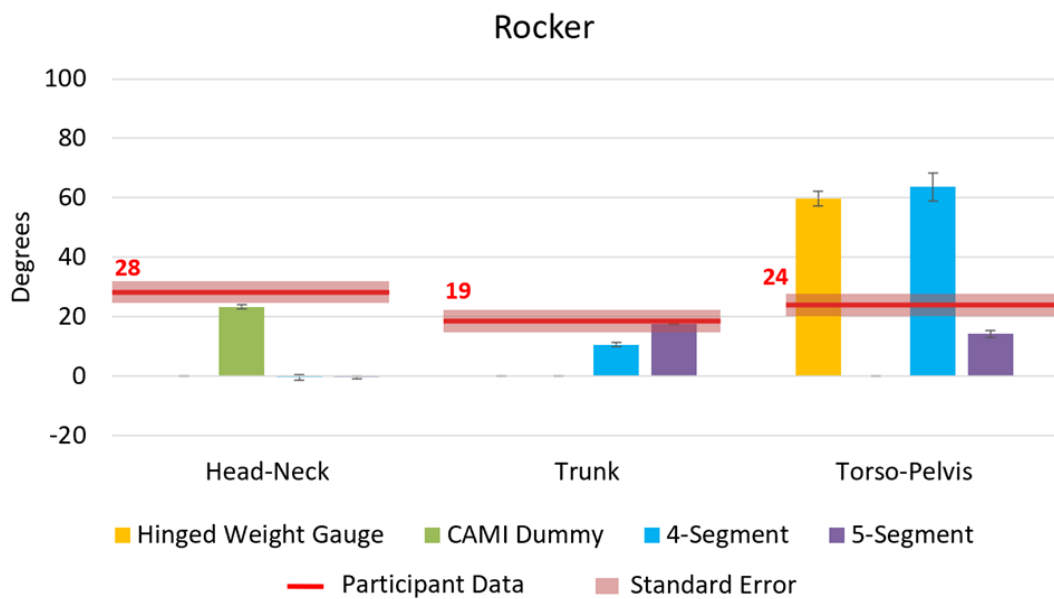
**Figure 228.** Motion capture kinematic data from human subjects study (red lines) compared to different sagittal plane devices in the infant carrier (S06).



**Figure 231.** Motion capture kinematic data from human subjects study (red lines) compared to different sagittal plane devices in the bouncer (S12).

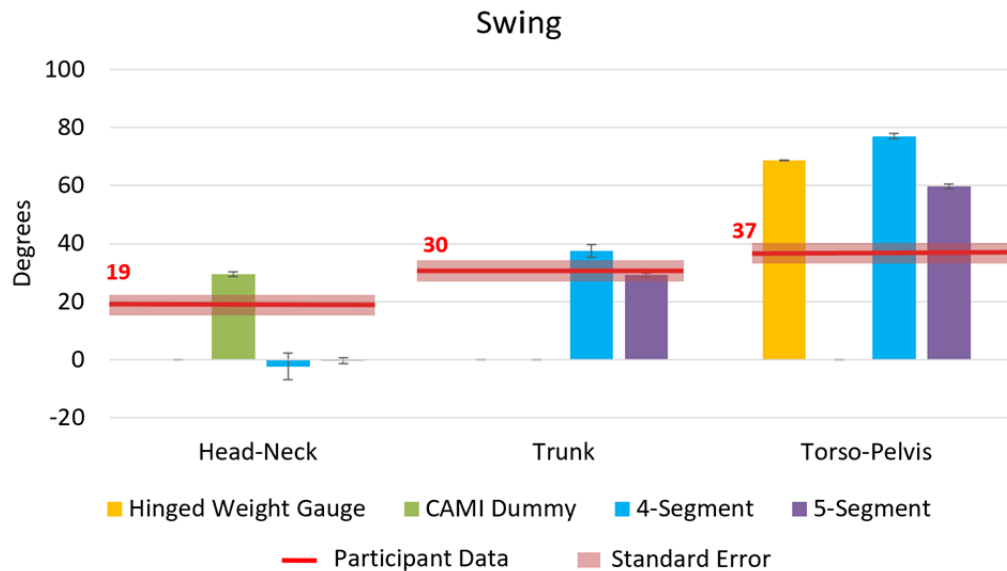


**Figure 233.** Motion capture kinematic data from human subjects study (red lines) compared to different sagittal plane devices in the stroller (S17).



**Figure 232.** Motion capture kinematic data from human subjects study (red lines) compared to different sagittal plane devices in the rocker (S16).





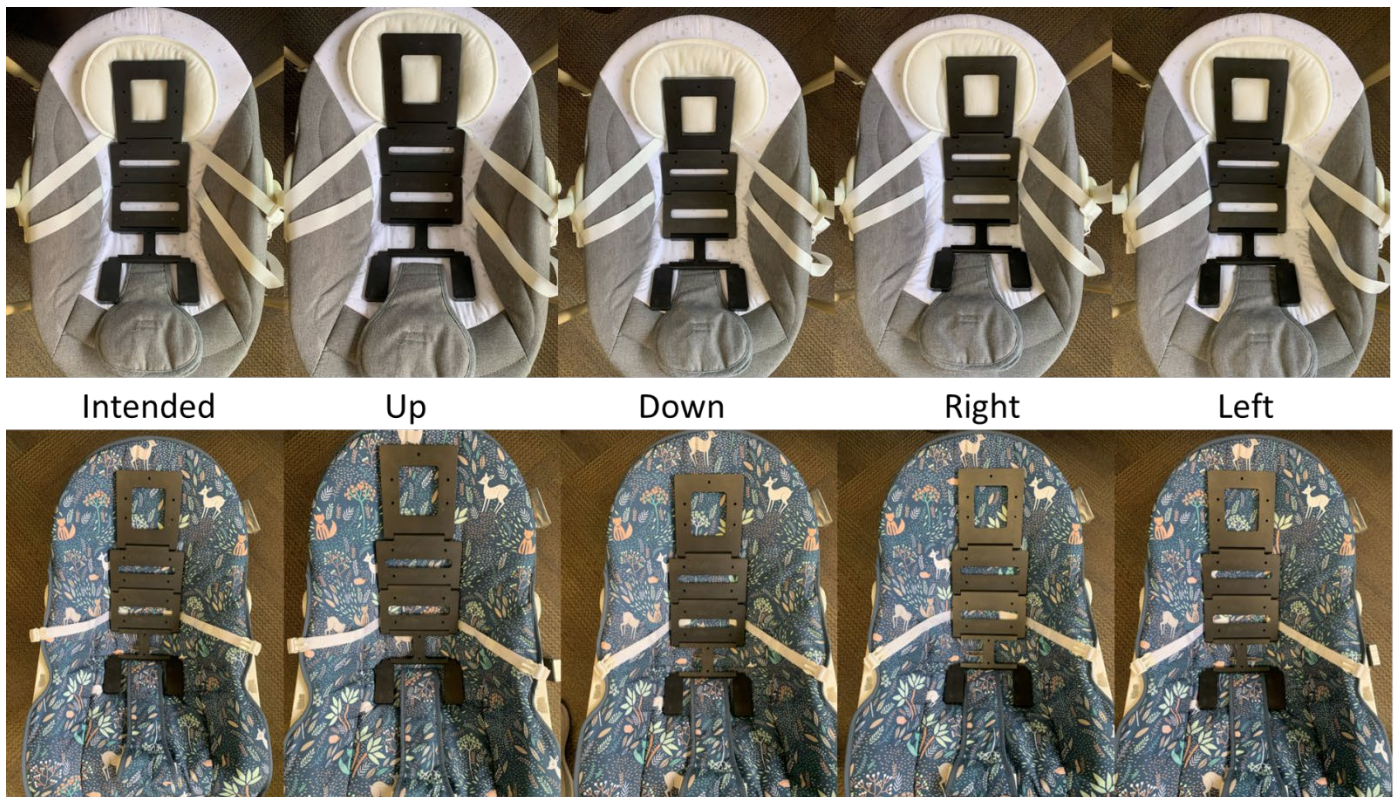
**Figure 236.** Motion capture kinematic data from human subjects study (red lines) compared to different sagittal plane devices in the swing (S24).

The five-segment sagittal plane device improved most kinematic measurements compared to the hinged weight gauge and four segment devices in the trunk flexion and torso-pelvis flexion measurements. In general, the head-neck flexion angles of the five-segment device were accurate only for the bouncer (S12) which features a plush head pillow. In other products, infants in our human subjects study exhibited a much larger head-neck angle compared to the angles measured from our five-segment device. None of the measurement devices predicted head-neck flexion particularly well, though the CAMI dummy came the closest due to the three-dimensional nature of the occiput of the head and the more realistic center of rotation compared to the nearly two-dimensional sagittal plane devices.

Trunk flexion was accurate for the rocker and swings with our five-segment sagittal plane device. Both products feature significant conformity and subjected infants in our human subjects study to trunk flexion of 19° and 30°, respectively. The torso-pelvis measurement was not consistent with the human subjects data, though the five-segment device was more accurate than other measurement devices.

We performed a sensitivity analysis to understand how placement of the five-segment sagittal plane device within the seated products influences the outcome angles. We placed the five-segment sagittal plane device in products S24 and S17 five times: in the intended position, up 1 cm, down 1 cm, to the right 1 cm, and to the left 1 cm (**Figure 103**). Head-neck, trunk, torso-pelvis, lower-torso-pelvis,

and hip-angles were recorded (**Figure 104**). Results show that the device measurements are not sensitive to off-center placement to the left or to the right, but that the placement of the five-segment sagittal plane device in the product with respect to high or low placement does influence the results. This makes sense and shows that the device is appropriately sensitive to correct placement within the seated product. Product S24 features a small pillow which affects the head-neck angle even with slight positional changes, especially because the pillow is not completely attached to the product. This means that infants also experience variability of body position with very slight changes in positioning. The results from product S17 demonstrate the importance of testing both an intended position and a slouched or worst-case scenario. Again, minor changes to the positioning significantly influenced the flexion angles which would translate to affecting infants lying within the products, even with minor position changes.



**Figure 239.** Sensitivity analysis showing how small deviations from the intended position may influence results for (top) S24 and (bottom) S17.

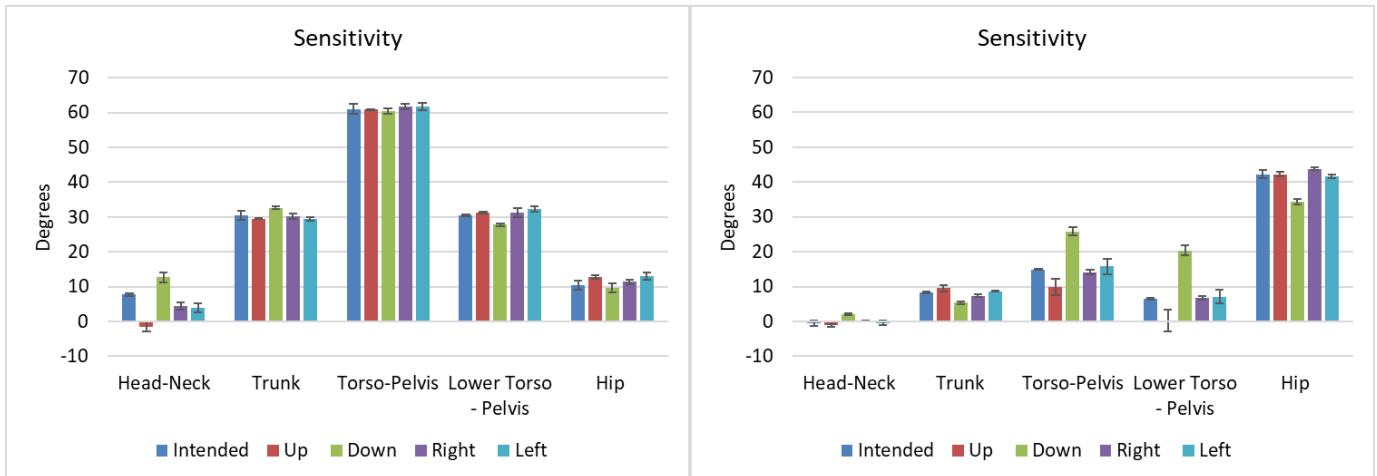
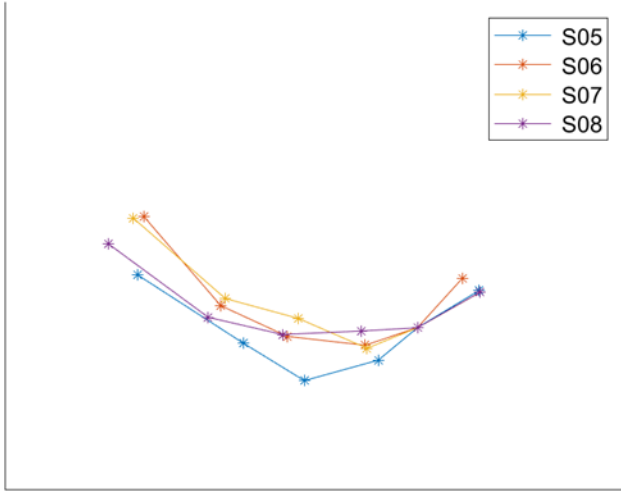


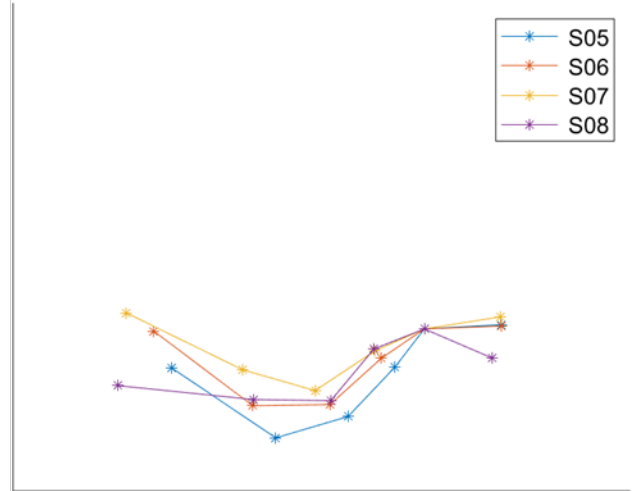
Figure 240. Results from sensitivity testing for (left) S24 and (right) S17.

Finally, we plotted only the relative position of each segment from the five-segment sagittal plane testing in each product category with the center of rotation between the pelvis and leg segments serving as a coincident point for all products. The purpose of these graphs is to visually show how an infant's body would be positioned within the infant carriers (Figure 105), bouncers (Figure 106), strollers (Figure 107), rockers (Figure 108), and swings (Figure 109). Again, infant floor seats are excluded due to the lack of support and the upright positioning which was not realistic for our nearly two-dimensional five-segment sagittal plane device.

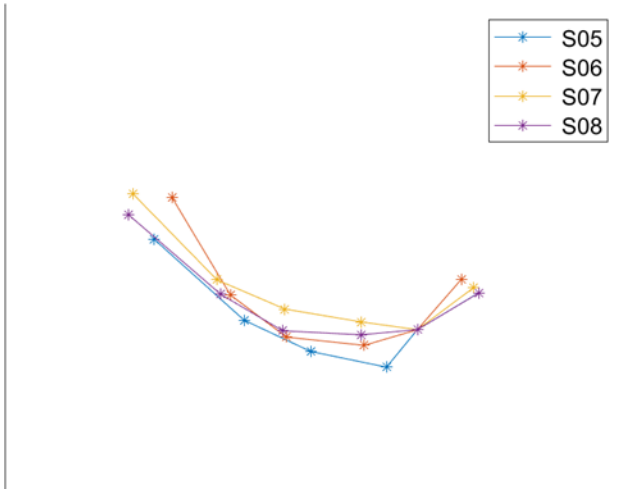
**Newborn - Intended Position**



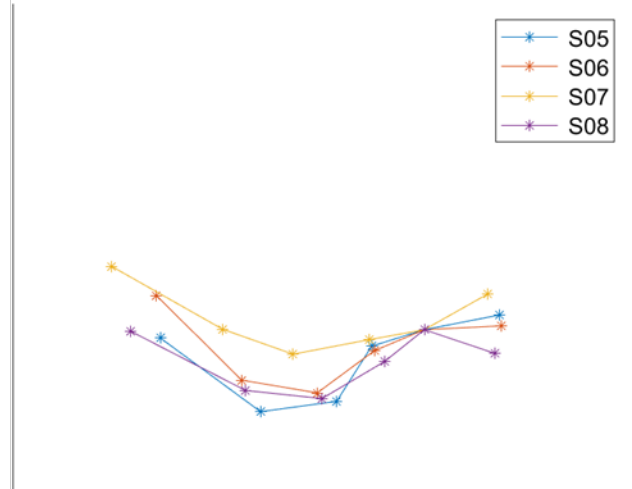
**Newborn - Slouched Position**



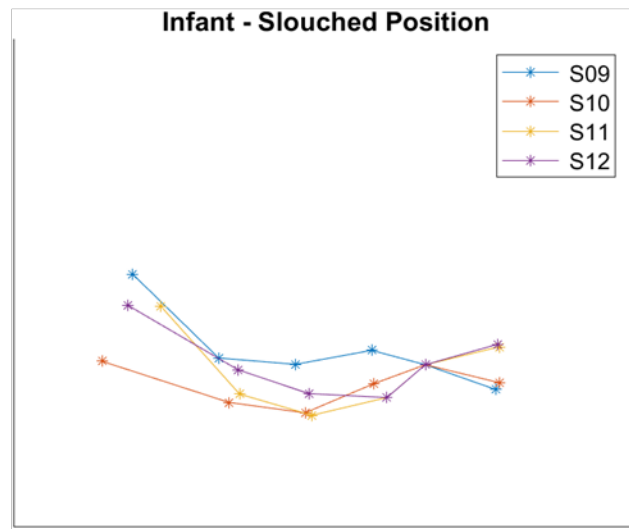
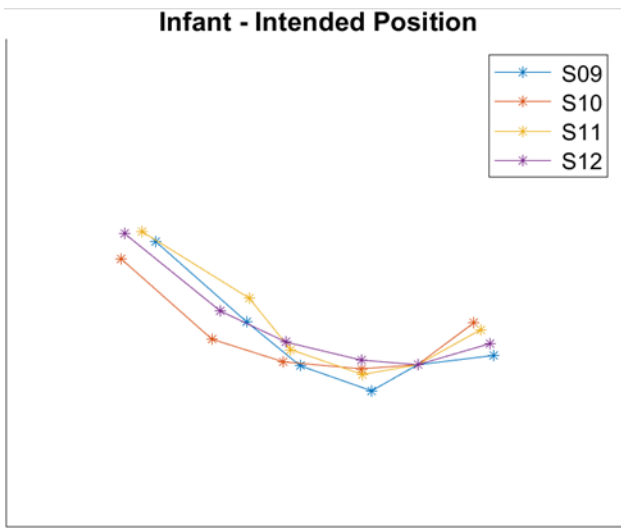
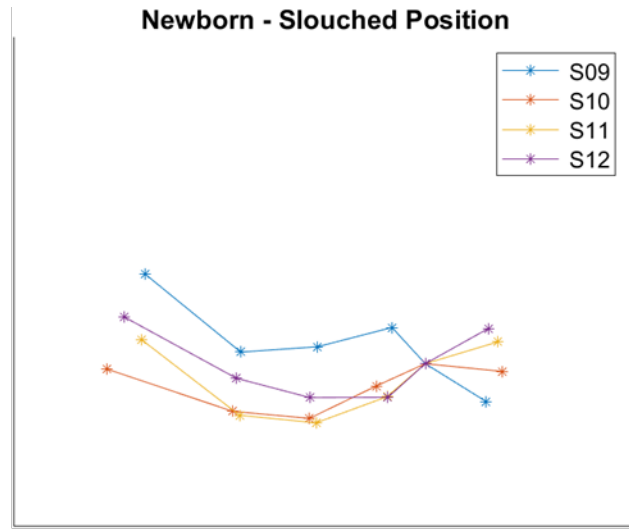
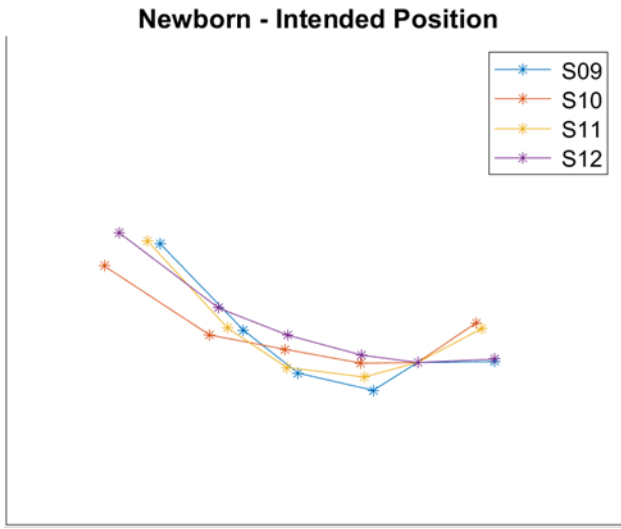
**Infant - Intended Position**



**Infant - Slouched Position**

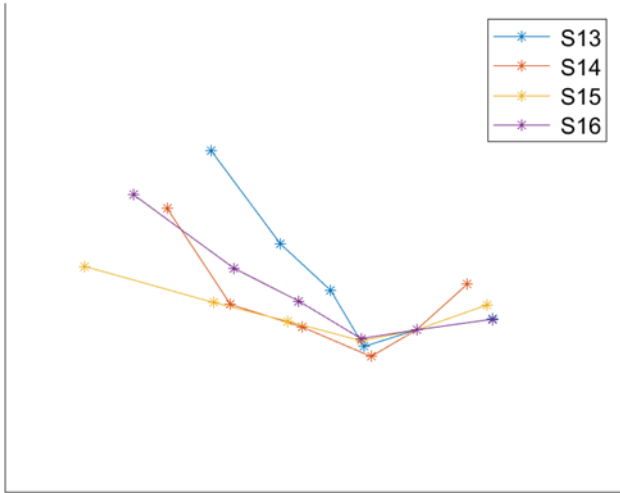


**Figure 241.** Sagittal plane kinematics for all infant carriers, presented with the center of rotation between the pelvis and leg sections coinciding for all infant carrier products.

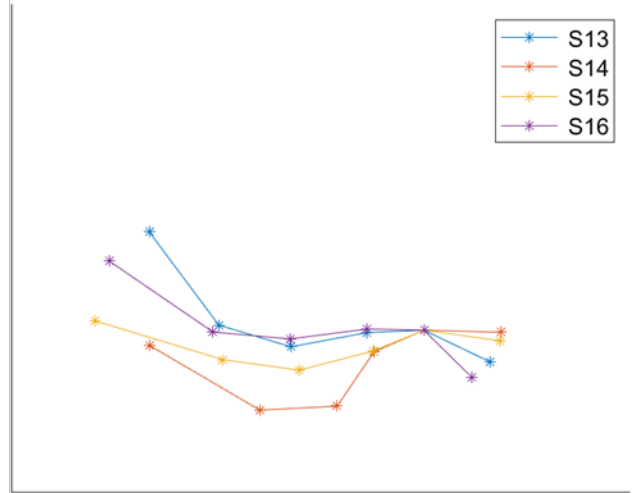


**Figure 242.** Sagittal plane kinematics for all bouncers, presented with the center of rotation between the pelvis and leg sections coinciding for all products.

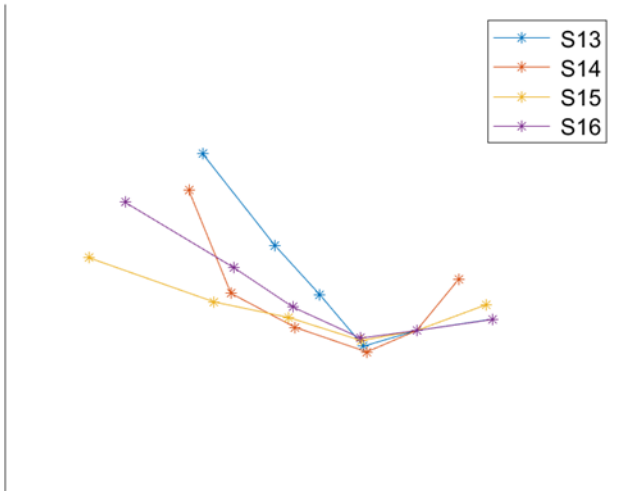
**Newborn - Intended Position**



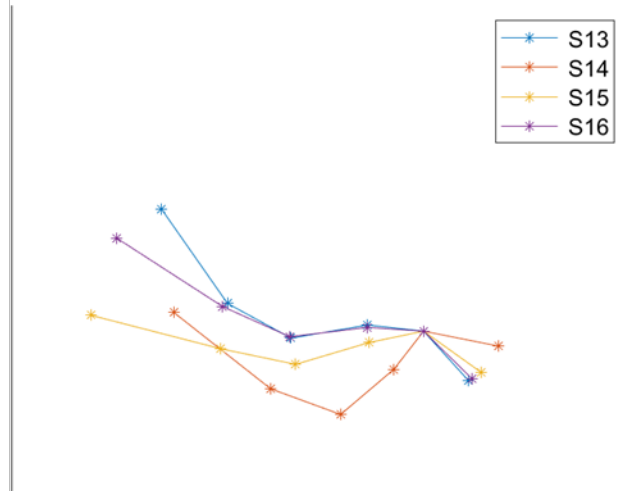
**Newborn - Slouched Position**



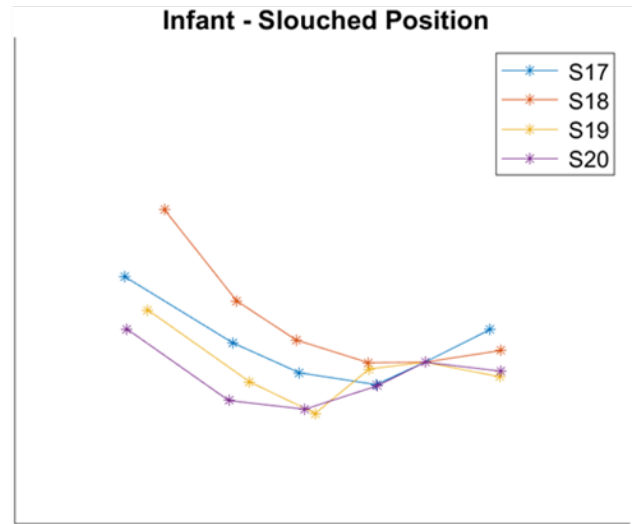
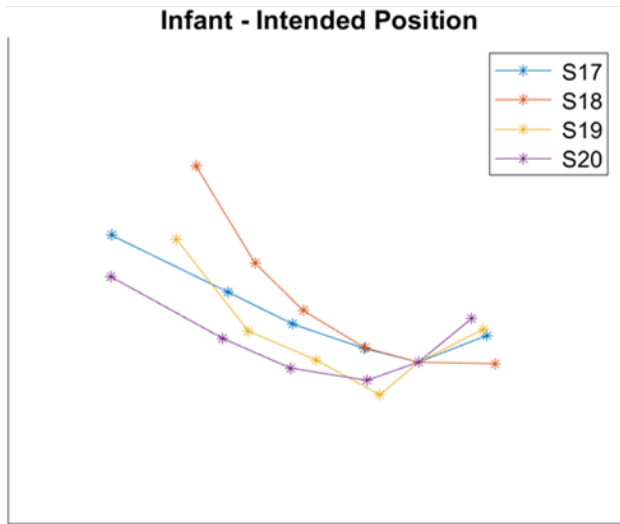
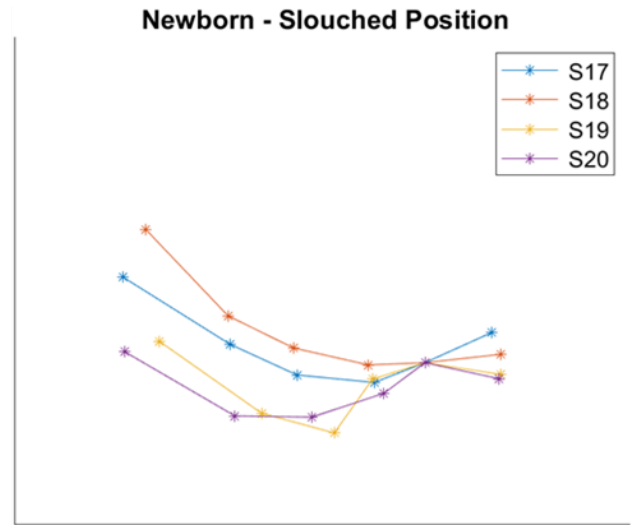
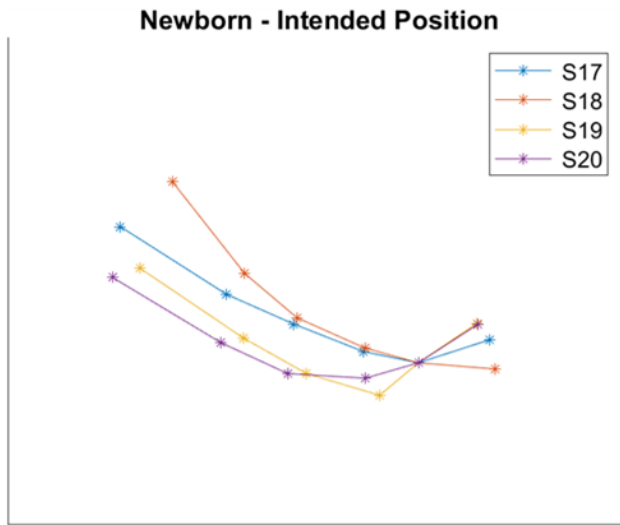
**Infant - Intended Position**



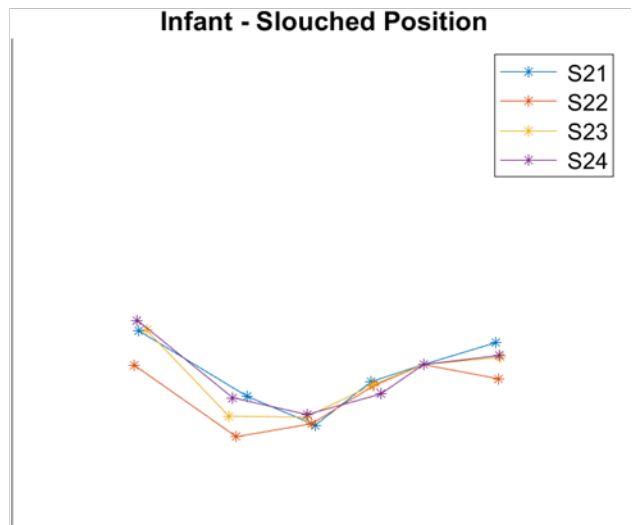
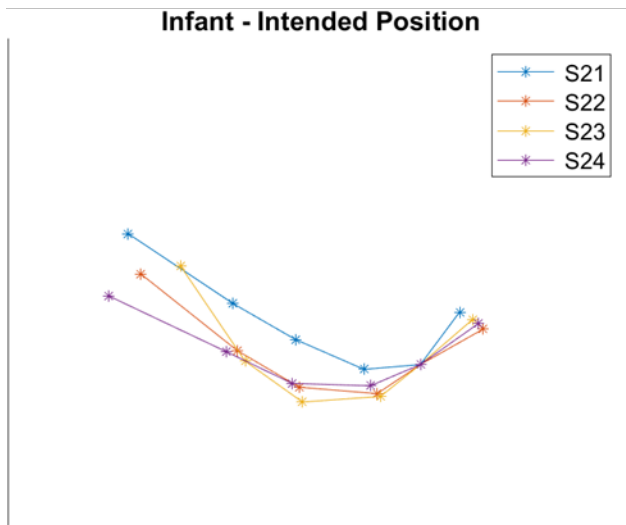
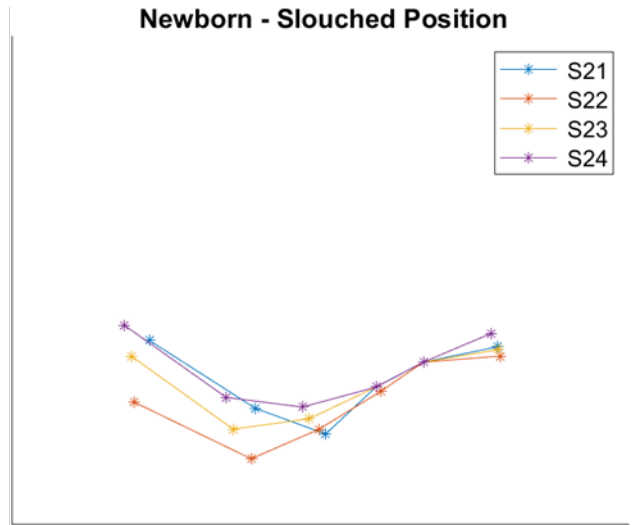
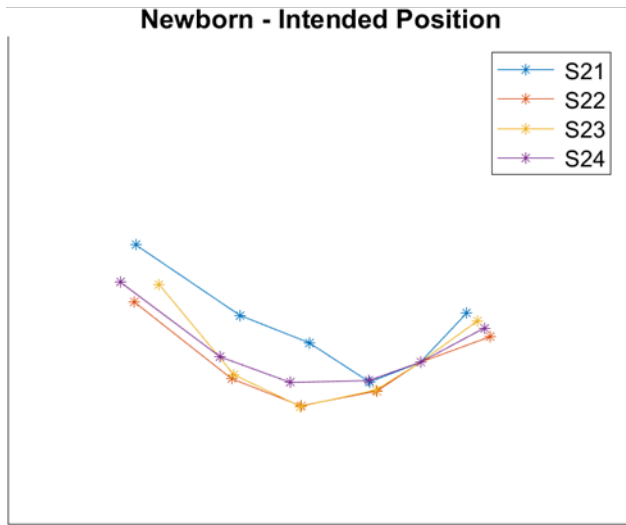
**Infant - Slouched Position**



**Figure 243.** Sagittal plane kinematics for all strollers, presented with the center of rotation between the pelvis and leg sections coinciding for all products.



**Figure 244.** Sagittal plane kinematics for all rockers, presented with the center of rotation between the pelvis and leg sections coinciding for all products.



**Figure 245.** Sagittal plane kinematics for all swings, presented with the center of rotation between the pelvis and leg sections coinciding for all products.



## 9.4 Sagittal Plane Testing Discussion

A device which can be easily manufactured by a machine shop and used to evaluate infant body position within a seated product will be beneficial as an eventual standardized test method to reduce positional asphyxiation risk for infants. The four-segment device we developed for our previous research related to infant pillows was sufficient to illustrate differences in body positions between products, but the lack of a pelvis segment and comparable human subjects data motivated the design of the five-segment sagittal plane device.

Our five-segment sagittal plane device provides a good estimation of trunk flexion in seated products when the device can be placed flush against the surface of the seated product without moving, sliding, or falling over in the product. Here is an example of an upright infant floor seat where the five-segment sagittal plane device is not recommended (**Figure 110**).

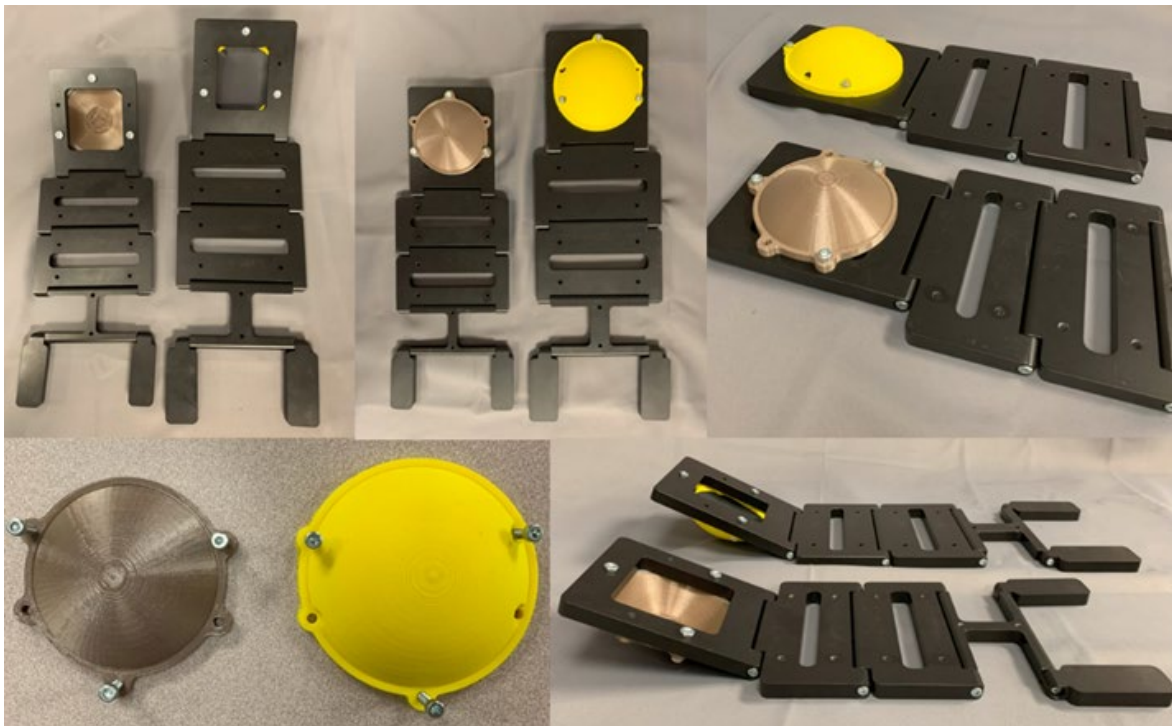


**Figure 246.** Example of the five-segment sagittal plane device not performing well in an upright infant floor seat product.

While the five-segment device produced reliable results for trunk flexion, the head-neck flexion and torso-pelvis results were less comparable to our human subjects data. Conversely, the measurements from the CAMI dummy were very close to the head-neck flexion data of the infants in our human subjects study. The three-dimensional nature of the CAMI dummy head as well as the center-of-rotation being more anatomically accurately explains the accuracy of the CAMI dummy head-

neck flexion compared to other primarily two-dimensional devices. Furthermore, the CAMI dummy has many limitations (availability, lack of trunk flexion, and cost).

Because the CAMI dummy head-neck flexion results provided the most accurate measurements of all devices, we explored the idea of adding three-dimensional head geometry to our sagittal plane device (**Figure 111**). We printed three dimensional hemispheres (1/3<sup>rd</sup> of the diameter in height) with diameters similar to those of newborn and 3-month old infants, and attached each hemisphere to the backside of the head segment of the five-segment sagittal plane device to mimic the three dimensional shape of an infant's head (Center for Disease Control and Prevention, 2001). While a good idea in theory, there are limitations to this initial concept. First of all, the hemispheres are uniform and symmetric which is very different than the occipital shape of the posterior of infants' heads. Secondly, the center of rotation with the upper torso segment in the anterior-posterior direction is not anatomically correct in this model. In the future, we want to add three-dimensional geometry to each segment to more accurately represent the locations of the centers of rotations between each body segment. We believe this is the direction we need to continue working towards to improve the head-neck flexion accuracy compared to the human subjects data.



**Figure 247.** Photos of the five-segment sagittal plane devices with preliminary three-dimensional head geometry modeled as a hemisphere with 1/3<sup>rd</sup> of the diameter height.

## 9.5 Sagittal Plane Testing Conclusions

Understanding and quantifying the influence of a seated product on an infant's sagittal plane kinematics (particularly head-neck flexion and trunk flexion) is critical to better evaluate the risk of positional asphyxiation, especially during a vulnerable sleep state. We recommend further development of the five-segment sagittal plane device to include three-dimensional geometry to improve the accuracy of the head-neck flexion angle measurements.

Once the head-neck angle estimations of the five-segment sagittal plane device are more accurate, we recommend sagittal plane testing for seated products if the device can be placed flush against the surface of the seated product without moving, sliding, or falling over in the product. In parallel with the improvement of the accuracy of the sagittal plane device, we recommend that additional human subjects testing be conducted to better elucidate thresholds for head-neck flexion and trunk flexion of infants. While medical literature confirms that head-neck flexion and trunk flexion negatively influence breathing, a robust and controlled study to isolate these variables would benefit the industry as they strive to innovate safe products for infants.

If a simple and accurate test-lab style sagittal plane device that can measure head-neck and trunk flexion with meaningful thresholds for safety is implemented into seated products standards, we believe the risk of positional asphyxia will be significantly reduced.

## 10. Summary of Key Points, Recommendations, and Conclusions

Based on our review of the IDIs, evaluations of seated products, *in vivo* human subjects testing of infants, and our own experience and expertise in relevant fields, we offer the following summary of key points, recommendations, and conclusions:

### Recommendations for Seated Product Testing and Requirements

1. A firmness test should be performed on all seated products following the methodology in section 6, with a requirement of a maximum displacement of 11 mm under a 10 N applied load.
2. Seated products should not have soft, loosely connected, or tethered pillow or body-insert features which can cover an infant's face and introduce a suffocation hazard, even in a supine lying position as seen in some IDI reviews. The head rotation testing and conformity testing showed how these features can envelop an infant's face during a normal 90° head rotation, which results in the mouth/nose contacting the surface, introducing suffocation-related hazards.

### Future Testing and Research Directions

1. Body position of infants is a critical factor in seated products, and our *in vivo* human subjects testing on these products revealed concerning body positions. Our five-segment sagittal plane testing device is progressing toward becoming a valid measurement tool to estimate body position, but further research is required to improve the head-neck flexion results and to determine thresholds for safety. An *in vivo* human subjects study focused on controlling infant body position and measuring respiratory outcomes as the primary variables is recommended.
2. Tip-over testing on seated products should be performed on softer and less stable surfaces that are representative of the surfaces on which these products have been used in the incident data. In the IDIs we reviewed, tip-overs occurred when products were placed on softer surfaces such as adult beds or couches. Additional research is required to develop a meaningful test for this hazard.
3. The base-of-support of products should be further explored. In the IDIs we reviewed, tip-over incidents occurred most frequently in products which featured product surface dimensions greater than the base dimensions as revealed in our product characterization measurements.
4. The concavity of a seated product influences how an infant's mouth/nose interacts with that product, both during normal supine lying with a head rotation, and if the infant rolls over into a prone position. While a sufficiently firm product theoretically should reduce the incidence of

suffocation-related incidents, there is no existing research that shows that concave but firm products decrease suffocation hazards. Based on our product characterization, a concavity test could be performed on seated products (excluding infant carriers since they are designed for crash situations; and infant floor seats since the design is not appropriate for this test) following the methodology in section 5, with a requirement of a minimum radius of 22 cm.

5. Significant attention should be given to ways to make convertible products (those which span product categories) and infant-to-toddler products unusable by infants in settings not intended for infants. The IDIs revealed that significant hazards can arise when products are used outside of the intended setting.
6. As evidenced in the IDIs, many parents do not use the harnesses or restraints in seated products. The juvenile products industry should consider how or if product design features can encourage, facilitate, or even require restraint engagement during use.
7. More research should be conducted on common materials, combinations of materials, and back supports to understand the influence of material selections on suffocation-related safety in infant gear. In particular, research related to firmness, airflow, and the exchange of gases during breathing could help inform designs which reduce suffocation risk.

#### Public Information

1. Discharge information from hospitals and infant well-child visits should include guidance on, or warnings against, the unsafe use of infant seated products for sleep or unattended awake time. Based on our experience and expertise, hospitals often use these products for infants in the clinical setting, while infants are constantly monitored and restrained, which could lead parents to believe these products are safe for infants at all times at home. Some IDIs stated that parents believed the seated products were a safe space for their infants to sleep.
2. Infant carriers should not be used outside of the motor vehicle for any duration of sleep. In our *in vivo* human subjects testing, these products resulted in the most concerning head-neck flexion and torso-pelvis flexion of all product categories. The narrow base of support also results in easier tip-overs compared to other products with larger footprints, as discussed in the product characterization and demonstrated through IDIs. Infant carriers are designed for motor vehicle use where an adult is present with the infant. The design of these products reduces death in crash situations. They are not designed for nor are they safe for any duration of sleep outside of a motor vehicle.

3. Infants, especially younger infants, should not be placed in seated products for sleep, even for short duration naps. Our *in vivo* human subjects testing showed concerning body positions that can negatively influence breathing when infants are in seated products, which could introduce more hazards in a sleeping and/or unattended infant. If an infant falls asleep in a seated product, they should be moved to a space consistent with the AAP's Safe Sleep guidelines.
4. Marketing documents should avoid ambiguous terms without defined meanings in the context of infant product safety, such as "breathable" or "healthy", for example, as this may confuse or mislead consumers with regard to safety of products.
5. Warning label language related to motor milestone achievement on a firm flat surface (for example, "stop using this product when your infant begins rolling") should be used with caution and only if relevant for seated products because seated products represent a very different mechanical environment than a firm flat surface. Our *in vivo* human subjects testing showed significantly different body positions and muscle activity of infants in seated products compared to a firm flat surface. An infant may be able to achieve movements in seated product mechanical environments before they could do so on a firm flat surface, which could introduce additional hazards.
6. As an infant's motor skills and strength develop, seated products offer a new mechanical environment and a differing visual perspective which infants  $\geq 4$  months may benefit from during awake and supervised play. Our *in vivo* human subjects data show that these older infants have more muscle activity and movement within seated products during awake time.
7. While infants  $< 4$  months also benefit from a varied visual perspective during awake and supervised play offered by seated products, these younger infants do not have the muscle strength and coordination to control their own body positions within the products. Our *in vivo* human subjects data showed that younger infants were more passive in the products compared to a firm flat surface, limiting the benefits related to motor development within the seated product environment.
8. Infants placed or who have rolled into the prone position in a seated product experience suffocation-related hazards due to the conformity, concavity, and/or soft goods in the space. Our *in vivo* human subjects data also revealed an increased use of abdominal muscle activity during prone lying in seated products compared to a firm flat surface, meaning that muscles are working overtime and would fatigue more quickly. If an infant cannot self-correct or a caregiver is not alerted, the hazards can result in death as evidenced in the IDIs we reviewed.

We believe that implementation of these recommendations will reduce the risk of suffocation or positional asphyxiation related deaths of infants within seated products. We acknowledge that we reviewed only a sampling of products in each product category in this study, so products which may fall outside of the range of products we examined may produce different results. We also note that in order to obtain full data sets of 9 participants in all test conditions, that we tested 13 infants and where data was available from more than 9 participants it was reported. While many of our results are statistically significant, the field would benefit from larger and/or multi-laboratory studies.

This study was intended to show an overview of the hazards and benefits of a broad range of products. When analyzing any individual product, a comprehensive assessment is required to fully characterize the hazards and benefits which may be unique to that individual product.

## References

- Abreu e Silva, F. A., MacFadyen, U. M., Williams, A., and Simpson, H. (1985). Sleep apnoea in infancy. *Journal of the Royal Society of Medicine*, 78(12), 1005–1008.  
<https://doi.org/10.1177/014107688507801205>
- Adler, S.S., Beckers, D., Buck, M., (2007). PNF in practice: an illustrated guide. Springer Science and Business Media.
- Altmann, T. R., and Hill, D. L. (2019). Caring for Your Baby and Young Child: Birth to Age 5. American Academy of Pediatrics. <https://doi.org/10.1542/9781610023443>.
- Ammari A, Schulze KF, Ohira-Kist K, et al. (2009). Effects of body position on thermal, cardiorespiratory and metabolic activity in low birth weight infants. *Early Hum Dev.*, 85(8):497-501.
- Bhat RY, Leipälä JA, Singh NR, Rafferty GF, Hannam S, Greenough A. (2003). Effect of posture on oxygenation, lung volume, and respiratory mechanics in premature infants studied before discharge. *Pediatrics*, 112(1 Pt 1):29-32.
- Bishop, B. (1963). Abdominal muscle and diaphragm activities and cavity pressures in pressure breathing. *J. Appl. Physiol.* 18, 37–42. <https://doi.org/10.1152/jappl.1963.18.1.37>.
- Blumberg MS. (2015). Developing Sensorimotor Systems in Our Sleep. *Curr Dir Psychol Sci.* 24(1):32-37. doi: 10.1177/0963721414551362. PMID: 25937709; PMCID: PMC4414046.
- Bolivar, J.M., Gerhardt, T., Gonzalez, A., Hummler, H., Claire, N., Everett, R., Bancalari, E. (1995). Mechanisms for episodes of hypoxemia in preterm infants undergoing mechanical ventilation. *J. Pediatr.* 127, 767–773. [https://doi.org/10.1016/S0022-3476\(95\)70171-0](https://doi.org/10.1016/S0022-3476(95)70171-0).
- Callister, W. D., Rethwisch, D. G. (2014). *Material Science and Engineering: An Introduction.* (D. Sayre, Ed.). D. Fowley.
- Carleton, J. N., Donoghue, A. M., and Porter, W. K. (1998). Mechanical model testing of rebreathing potential in infant bedding materials. *Archives of Disease in Childhood*, 78(4), 323–328.  
<https://doi.org/10.1136/adc.78.4.323>
- Carlo WA, Beoglos A, Siner BS, Martin RJ, (1989). Neck and body position effects on pulmonary mechanics in infants. *Pediatrics.* 84(4):670-674.
- Centers for Disease Control and Prevention. (2001). Growth charts - data table of infant head circumference-for-age charts. Centers for Disease Control and Prevention.  
[https://www.cdc.gov/growthcharts/html\\_charts/hcageinf.htm](https://www.cdc.gov/growthcharts/html_charts/hcageinf.htm).
- Chandler, R. F. (1974, March). Construction of an Infant Dummy (Mark II) for Dynamic Tests of Crash Restraint Systems (Includes Revision 1 and 2). Report number AAC-119-74-14.
- Cherniack NS, Longobardo GS. Oxygen and carbon dioxide gas stores of the body. *Physiological Reviews* 1970;50:196–243.



- Chowdhury, R. T. (2020). Injuries and Deaths Associated with Nursery Products Among Children Younger than Age Five. Consumer Product Safety Commission.
- Côté, A., Gerez, T., Brouillette, R.T., Laplante, S. (2000). Circumstances leading to a change to prone sleeping in sudden infant death syndrome victims. *Pediatrics* 106, E86. <https://doi.org/10.1542/peds.106.6.e86>.
- Cresswell, A.G., Grundström, H., Thorstensson, A. (1992). Observations on intra- abdominal pressure and patterns of abdominal intra-muscular activity in man. *Acta Physiol. Scand.* 144, 409–418. <https://doi.org/10.1111/j.1748-1716.1992.tb09314.x>.
- Davis GM, Coates AL, Papageorgiou A, Bureau MA. Direct measurement of static chest wall compliance in animal and human neonates. *Journal of Applied Physiology* 1988;65:1093–8.
- Davis KF, Parker KP, Montgomery GL. (2004). Sleep in infants and young children: Part one: normal sleep. *J Pediatr Health Care.* 18(2):65-71. doi: 10.1016/s0891-5245(03)00149-4. PMID: 15007289.
- Decon. (2022). Textile stiffening agent. Retrieved April 28, 2023, from <https://www.polyestermfg.com/portfolio-items/textile-stiffening-agent/>.
- Don, G. W., Kirjavainen, T., Broome, C., Seton, C., and Waters, K. A. (2000). Site and mechanics of spontaneous, sleep-associated obstructive apnea in infants. *Journal of applied physiology* (Bethesda, Md. : 1985), 89(6), 2453–2462. <https://doi.org/10.1152/jappl.2000.89.6.2453>
- Duncan JR, Byard RW. (2018). Sudden Infant Death Syndrome: An Overview. In: Duncan JR, Byard RW, editors. *SIDS Sudden Infant and Early Childhood Death: The Past, the Present and the Future*. Adelaide (AU): University of Adelaide Press; Chapter 2. Available from: <https://www.ncbi.nlm.nih.gov/books/NBK513399/>
- El Shakankiry H. M. (2011). Sleep physiology and sleep disorders in childhood. *Nature and science of sleep*, 3, 101–114. <https://doi.org/10.2147/NSS.S22839>
- Esquer, C., Claire, N., D’Ugard, C., Wada, Y., Bancalari, E. (2008). Mechanisms of hypoxemia episodes in spontaneously breathing preterm infants after mechanical ventilation. *Neonatology* 94, 100–104. <https://doi.org/10.1159/000116634>.
- Esquer, C., Claire, N., D’Ugard, C., Wada, Y., Bancalari, E., (2007). Role of abdominal muscles activity on duration and severity of hypoxemia episodes in mechanically ventilated preterm infants. *Neonatology* 92, 182–186. <https://doi.org/10.1159/000102056>.
- Fok TF, Ng PC, Wong W, Lee CH, So KW. (1997). High frequency oscillatory ventilation in infants with increased intra-abdominal pressure. *Arch Dis Child Fetal Neonatal Ed.* 76(2):F123-5. doi: 10.1136/fn.76.2.f123. PMID: 9135292; PMCID: PMC1720625
- Franchak JM. Changing Opportunities for Learning in Everyday Life: Infant Body Position Over the First Year. *Infancy.* 2019 Mar;24(2):187-209. doi: 10.1111/infa.12272. Epub 2018 Oct 23. PMID: 32677202.

- Franco, P., Seret, N., Van Hees, J. N., Scaillet, S., Vermeulen, F., Groswasser, J., and Kahn, A. (2004). Decreased arousals among healthy infants after short-term sleep deprivation. *Pediatrics*, 114(2), e192–e197. <https://doi.org/10.1542/peds.114.2.e192>.
- Goldberg J, Hornung R, Yamashita T, Wehrmacher W. (1986). Age at death and risk factors in sudden infant death syndrome. *Aust Paediatr J*. 22 Suppl 1:21-8. PMID: 3789998.
- Goldman, J.M., Lehr, R.P., Millar, A.B., Silver, J.R., (1987). An electromyographic study of the abdominal muscles during postural and respiratory manoeuvres. *J. Neurol. Neurosurg. Psychiatry* 50 (7), 866–869. <https://doi.org/10.1136/jnnp.50.7.866>
- Haase, B., Badinska, A.-M., Maiwald, C. A., Poets, C. F., and Springer, L. (2021). Comparison of nostril sizes of newborn infants with outer diameter of endotracheal tubes. *BMC Pediatrics*, 21(1). <https://doi.org/10.1186/s12887-021-02889-5>
- Haddad, G. G., Walsh, E. M., Leistner, H. L., Grodin, W. K., and Mellins, R. B. (1981). Abnormal maturation of sleep states in infants with aborted sudden infant death syndrome. *Pediatric research*, 15(7), 1055–1057. <https://doi.org/10.1203/00006450-198107000-00016>
- Henderson-Smart DJ, Read DJC. Depression of Respiratory Muscles and Defective Responses to Nasal Obstruction during Active Sleep in the Newborn. *Journal of Paediatrics and Child Health* 1976;12:261–6.
- Henderson-Smart, D. J., and Read, D. J. (1979). Reduced lung volume during behavioral active sleep in the newborn. *Journal of applied physiology: respiratory, environmental and exercise physiology*, 46(6), 1081–1085. <https://doi.org/10.1152/jappl.1979.46.6.1081>
- Hoppenbrouwers, T., Hodgman, J. E., and Cabal, L. (1993). Obstructive apnea, associated patterns of movement, heart rate, and oxygenation in infants at low and increased risk for SIDS. *Pediatric pulmonology*, 15(1), 1–12. <https://doi.org/10.1002/ppul.1950150102>
- Horemuzova E, Katz-Salamon M, Milerad J. (2000). Breathing patterns, oxygen and carbon dioxide levels in sleeping healthy infants during the first nine months after birth. *Acta Paediatr.*, 89(11): 1284–1289
- Horne RS, Franco P, Adamson TM, Groswasser J, Kahn A. (2002). Effects of body position on sleep and arousal characteristics in infants. *Early Hum Dev.*, 69(1-2):25-33.
- Horne, R. S., Osborne, A., Vitkovic, J., Lacey, B., Andrew, S., Chau, B., Cranage, S. M., and Adamson, T. M. (2002). Arousal from sleep in infants is impaired following an infection. *Early human development*, 66(2), 89–100. [https://doi.org/10.1016/s0378-3782\(01\)00237-7](https://doi.org/10.1016/s0378-3782(01)00237-7)
- Hough J, Trojman A, Schibler A. (2016). Effect of time and body position on ventilation in premature infants. *Pediatr Res*. 80(4):499-504. Jones MW. Supine and prone infant positioning: a winning combination. *J Perinat Educ*. 2004 Winter;13(1):10-20. doi: 10.1624/105812404X109357. PMID: 17273371; PMCID: PMC1595182.
- Huang J, Karamessinis LR, Pepe ME, et al. Upper airway collapsibility during REM sleep in children with the obstructive sleep apnea syndrome. *Sleep*. 2009;32(9):1173-1181.

- Hunt CE, Corwin MJ, Lister G, Weese-Mayer DE, Neuman MR, Tinsley L, Baird TM, Keens TG, Cabral HJ. (1999). Longitudinal assessment of hemoglobin oxygen saturation in healthy infants during the first 6 months of age. Collaborative Home Infant Monitoring Evaluation (CHIME) Study Group. *J Pediatr.* 135(5):580-6. doi: 10.1016/s0022-3476(99)70056-9. PMID: 10547246.
- Jones MW. (2004). Supine and prone infant positioning: a winning combination. *J Perinat Educ.* 13(1):10-20. doi: 10.1624/105812404X109357. PMID: 17273371; PMCID: PMC1595182.
- Kahn, A., Blum, D., Waterschoot, P., Engelman, E., and Smets, P. (1982). Effects of obstructive sleep apneas on transcutaneous oxygen pressure in control infants, siblings of sudden infant death syndrome victims, and near miss infants: comparison with the effects of central sleep apneas. *Pediatrics*, 70(6), 852–857.
- Katz, E. S., Mitchell, R. B., and D'Ambrosio, C. M. (2012). Obstructive sleep apnea in infants. *American journal of respiratory and critical care medicine*, 185(8), 805–816. <https://doi.org/10.1164/rccm.201108-1455CI>
- Katz ES, Marcus CL, White DP. Influence of airway pressure on genioglossus activity during sleep in normal children. *Am J Respir Crit Care Med* 2006;173:902-9.
- Katz ES, White DP. Genioglossus activity during sleep in normal control subjects and children with obstructive sleep apnea. *Am J Respir Crit Care Med* 2004;170:553-60.
- Katz ES, White DP. Genioglossus activity during sleep in normal control subjects and children with obstructive sleep apnea. *Am J Respir Crit Care Med* 2004;170:553–560.
- Knill R, Andrews W, Bryan AC, Bryan MH. Respiratory load compensation in infants. *Journal of Applied Physiology* 1976;40:357–61.
- Kobayashi, Y., Watanabe, H., Taga, G., (2016). Movement patterns of limb coordination in infant rolling. *Exp. Brain Res.* 234 (12), 3433–3445. <https://doi.org/10.1007/s00221-016-4741-2>.
- Kohyama J, Sakuma H, Shiiki T, Shimohira M, Hasegawa T. Quantitative analysis of paradoxical inward rib cage movement during sleep in children. *Psychiatry and Clinical Neurosciences* 2000;54:328–9.
- Lee, L.-J., Chang, A.T., Coppieters, M.W., Hodges, P.W., (2010). Changes in sitting posture induce multiplanar changes in chest wall shape and motion with breathing. *Respir. Physiol. Neurobiol.* 170 (3), 236–245. <https://doi.org/10.1016/j.resp.2010.01.001>.
- Lin, F., Parthasarathy, S., Taylor, S.J., Pucci, D., Hendrix, R.W., Makhsous, M., (2006). Effect of different sitting postures on lung capacity, expiratory flow, and lumbar lordosis. *Arch. Phys. Med. Rehabil.* 87 (4), 504–509. <https://doi.org/10.1016/j.apmr.2005.11.031>.
- Lijowska, A. S., Reed, N. W., Chiodini, B. A., and Thach, B. T. (1997). Sequential arousal and airway-defensive behavior of infants in asphyxial sleep environments. *Journal of applied physiology* (Bethesda, Md. : 1985), 83(1), 219–228. <https://doi.org/10.1152/jappl.1997.83.1.219>
- Lopes JM, Muller NL, Bryan MH, Bryan AC. (1981). Synergistic behavior of inspiratory muscles after diaphragmatic fatigue in the newborn. *J Appl Physiol Respir Environ Exerc Physiol*, Sep;51(3):547-51. doi: 10.1152/jappl.1981.51.3.547. PMID: 7327953.

- Mage DT, Donner M. (2009). A Unifying Theory for SIDS. *Int J Pediatr.* 2009;368270. doi: 10.1155/2009/368270. PMID: 20049339; PMCID: PMC2798085.
- Maltese, M. R., and Leshner, M. (2019). Carbon dioxide rebreathing induced by crib bumpers and mesh liners using an infant manikin. *BMJ Paediatrics Open*, 3(1), e000374. <https://doi.org/10.1136/bmjpo-2018-000374>.
- Mannen EM, Carroll J, Bumpass DB, Rabenhorst B, Whitaker B, Wang J, Siddicky SF. (2019). United States Consumer Product Safety Commission, Supplemental Notice of Proposed Rulemaking for Infant Sleep Products, TAB B: Biomechanical Analysis of Inclined Sleep, corrected pages. [https://www.cpsc.gov/s3fs-public/Dr-Mannen-Study-FINAL-Report-09-18-2019\\_Redacted.corrected\\_0.pdf?g.Jao0IN\\_zU.TjiX4FeSUM3SPc3Zt\\_25](https://www.cpsc.gov/s3fs-public/Dr-Mannen-Study-FINAL-Report-09-18-2019_Redacted.corrected_0.pdf?g.Jao0IN_zU.TjiX4FeSUM3SPc3Zt_25)
- Mannen EM, Davis W, Goldrod S, Lujan T, Siddicky SF, Whitaker B, Carroll J. (2022). United States Consumer Product Safety Commission, Technical Reports, Pillows Product Characterization and Testing. Posted October 12, 2022. <https://www.cpsc.gov/content/Pillows-Product-Characterization-and-Testing>.
- Mannen EM, Siddicky SF, Davis WD, Whitaker B, Carroll J. (2023) United States Consumer Product Safety Commission, Technical Reports, Crib Bumper Product Characterization and Testing. Posted January 19, 2023. <https://www.cpsc.gov/content/Crib-Bumper-Product-Characterization-and-Testing>.
- Marcus CL, Lutz J, Carroll JL, Bamford O. Arousal and ventilatory responses during sleep in children with obstructive sleep apnea. *J Appl Physiol* 1998;84:1926-36.
- Marcus CL, Moreira GA, Bamford O, Lutz J. Response to inspiratory resistive loading during sleep in normal children and children with obstructive apnea. *J Appl Physiol* 1999;87:1448-54.
- Martin RJ, Okken A, Rubin D. Arterial oxygen tension during active and quiet sleep in the normal neonate. *The Journal of Pediatrics* 1979;94:271-4.
- Mazmanyanyan P, Darakchyan M, Pinkham MI, Tatkov S. (2020). Mechanisms of nasal high flow therapy in newborns. *J Appl Physiol*, 128(4):822-829. doi: 10.1152/japplphysiol.00871.2019.
- McCall RB, Groark CJ, Hawk BN, Julian MM, Merz EC, Rosas JM, Muhamedrahimov RJ, Palmov OI, Nikiforova NV. Early Caregiver-Child Interaction and Children's Development: Lessons from the St. Petersburg-USA Orphanage Intervention Research Project. *Clin Child Fam Psychol Rev.* 2019 Jun;22(2):208-224. doi: 10.1007/s10567-018-0270-9. PMID: 30196471.
- McGraw, MB (1941). Neural maturation of the infant as exemplified in the righting reflex, or rolling from a dorsal to a prone position. *The Journal of Pediatrics*; 18(3):385-394. [https://doi.org/10.1016/S0022-3476\(41\)80189-9](https://doi.org/10.1016/S0022-3476(41)80189-9).
- McLaughlin KA, Fox NA, Zeanah CH, Sheridan MA, Marshall P, Nelson CA. Delayed maturation in brain electrical activity partially explains the association between early environmental deprivation and symptoms of attention-deficit/hyperactivity disorder. *Biol Psychiatry.* 2010 Aug 15;68(4):329-36. doi: 10.1016/j.biopsych.2010.04.005. Epub 2010 May 23. PMID: 20497899; PMCID: PMC3010237.

- McNamara, F., and Sullivan, C. E. (2000). Obstructive sleep apnea in infants: relation to family history of sudden infant death syndrome, apparent life-threatening events, and obstructive sleep apnea. *The Journal of pediatrics*, 136(3), 318–323. <https://doi.org/10.1067/mpd.2000.103568>
- Miller, M. J., Martin, R. J., Carlo, W. A., Fouke, J. M., Strohl, K. P., and Fanaroff, A. A. (1985). Oral breathing in newborn infants. *The Journal of pediatrics*, 107(3), 465–469. [https://doi.org/10.1016/s0022-3476\(85\)80535-7](https://doi.org/10.1016/s0022-3476(85)80535-7)
- Montemitro E, Franco P, Scaillet S, Kato I, Groswasser J, Villa MP, Kahn A, Sastre JP, Ecochard R, Thiriez G, Lin JS. (2008). Maturation of spontaneous arousals in healthy infants. *Sleep*. 31(1):47-54. doi: 10.1093/sleep/31.1.47. PMID: 18220077; PMCID: PMC2225547.
- Moon RY, Carlin RF, Hand I. (2022). Sleep-Related Infant Deaths: Updated 2022 Recommendations for Reducing Infant Deaths in the Sleep Environment. *Pediatrics* July 2022; 150 (1): e2022057990. 10.1542/peds.2022-057990.
- Morea A, Jessel J. (2020). Comparing the effects of varied and constant preferred items on improving tummy time for typically developing infants. *J Appl Behav Anal*. 53(3):1367-1382. doi: 10.1002/jaba.684. Epub 2020 Feb 6. PMID: 32026464.
- Nagase H, Yonetani M, Uetani Y, Nakamura H. Effects of child seats on the cardiorespiratory function of newborns. *Pediatr Int*. 2002 Feb;44(1):60-3. doi: 10.1046/j.1442-200x.2002.01507.x. PMID: 11982873.
- Ohman AM, Beckung ER. (2008). Reference values for range of motion and muscle function of the neck in infants. *Pediatr Phys Ther*. 2008 Spring;20(1):53-8. doi: 10.1097/PEP.0b013e31815ebb27. PMID: 18300934.
- Oishi Y, Ohta H, Hirose T, Nakaya S, Tsuchiya K, Nakagawa M, Kusakawa I, Sato T, Obonai T, Nishida H, Yoda H. (2018). Combined effects of body position and sleep status on the cardiorespiratory stability of near-term infants. *Sci Rep*. 8(1):8845. doi: 10.1038/s41598-018-27212-8. PMID: 29891999; PMCID: PMC5995963.
- Orr, W. C., Stahl, M. L., Duke, J., McCaffree, M. A., Toubas, P., Mattice, C., and Krous, H. F. (1985). Effect of sleep state and position on the incidence of obstructive and central apnea in infants. *Pediatrics*, 75(5), 832–835. PMID: 3991268.
- Paluszynska, D.A., Harris, K.A., Thach, B.T. (2004). Influence of sleep position experience on ability of prone-sleeping infants to escape from asphyxiating microenvironments by changing head position. *Pediatrics* 114, 1634–1639. <https://doi.org/10.1542/peds.2004-0754>.
- Panitch, H.B. (2015). Pulmonary complications of abdominal wall defects. *Paediatr. Respir. Rev*. <https://doi.org/10.1016/j.prrv.2014.10.004>.
- Parmelee, A. H., Jr, Wenner, W. H., Akiyama, Y., Schultz, M., and Stern, E. (1967). Sleep states in premature infants. *Developmental medicine and child neurology*, 9(1), 70–77. <https://doi.org/10.1111/j.1469-8749.1967.tb02212.x>
- Pelosi P, Quintel M, Malbrain ML. (2007). Effect of intra-abdominal pressure on respiratory mechanics. *Acta Clin Belg*. 62 Suppl 1:78-88. PMID: 17469705.

- Pereira, K. D., Rathi, N. K., Fatakia, A., Haque, S. A., and Castriotta, R. J. (2008). Body position and obstructive sleep apnea in 8-12-month-old infants. *International journal of pediatric otorhinolaryngology*, 72(6), 897–900. <https://doi.org/10.1016/j.ijporl.2008.03.002>
- Praud JP, Egreteau L, Benlabed M, Curzi-Dascalova L, Nedelcoux H, Gaultier C. (1991). Abdominal muscle activity during CO2 rebreathing in sleeping neonates. *J Appl Physiol* (1985). 70(3):1344-50. doi: 10.1152/jappl.1991.70.3.1344. PMID: 2033002.
- Purcell M. (1976). Response in the newborn to raised upper airway resistance. *Archives of disease in childhood*, 51(8), 602–607. <https://doi.org/10.1136/adc.51.8.602>
- Reed WR, Roberts JL, Thach BT. (1985). Factors influencing regional patency and configuration of the human infant upper airway. *J Appl Physiol* (1985). 58(2):635-44. doi: 10.1152/jappl.1985.58.2.635. PMID: 3980366.
- Reiterer F, Abbasi S, Bhutani VK, (1994). Influence of head-neck posture on airflow and pulmonary mechanics in preterm neonates. *Pediatr Pulmonol*. 17(3):149-54. doi: 10.1002/ppul.1950170303. PMID: 8196994.
- Richardson, H.L., Walker, A.M., Horne, R.S.C. (2008). Sleep position alters arousal processes maximally at the high-risk age for sudden infant death syndrome. *J. Sleep Res*. 17, 450–457. <https://doi.org/10.1111/j.1365-2869.2008.00683.x>.
- Roberts JL, Reed WR, Mathew OP, Menon AA, Thach BT. (1985). Assessment of pharyngeal airway stability in normal and micrognathic infants. *J Appl Physiol* (1985). 58(1):290-9. doi: 10.1152/jappl.1985.58.1.290. PMID: 3968018.
- Roeber BJ, Tober CL, Bolt DM, Pollak SD. Gross motor development in children adopted from orphanage settings. *Dev Med Child Neurol*. 2012 Jun;54(6):527-31. doi: 10.1111/j.1469-8749.2012.04257.x. Epub 2012 Mar 13. PMID: 22413752; PMCID: PMC3439199.
- Saiki T, Rao H, Landolfo F, Smith AP, Hannam S, Rafferty GF, Greenough A. (2009). Sleeping position, oxygenation and lung function in prematurely born infants studied post term. *Arch Dis Child Fetal Neonatal Ed*. 94(2):F133-7. doi: 10.1136/adc.2008.141374. PMID: 19240293.
- Savelsbergh GJ, van der Kamp J. (1994). The effect of body orientation to gravity on early infant reaching. *J Exp Child Psychol*. 58(3):510-28. doi: 10.1006/jecp.1994.1047. PMID: 7844502.
- Schwarz J, Spies JP, Bringmann H. (2012). Reduced muscle contraction and a relaxed posture during sleep-like Lethargus. *Worm*. 1(1):12-4. doi: 10.4161/worm.19499. PMID: 24058817; PMCID: PMC3670164.
- Siddicky, S. F., Bumpass, D. B., Krishnan, A., Tackett, S. A., McCarthy, R. E., and Mannen, E. M. (2020). Positioning and baby devices impact infant spinal muscle activity. *Journal of Biomechanics*, 104. <https://doi.org/10.1016/j.jbiomech.2020.109741>.
- Siddicky, S., Eckels, J., Rabenhorst, B., and Mannen, E. (2023). Ultrasonographic evaluation of infant hips in the Pavlik harness compared to body-worn commercial baby carriers. *Journal of orthopaedic research : official publication of the Orthopaedic Research Society*, 10.1002/jor.25571. Advance online publication. <https://doi.org/10.1002/jor.25571>.









- Siddicky, S. F., Wang, J., Rabenhorst, B., Buchele, L., and Mannen, E. M. (2021). Exploring infant hip position and muscle activity in common baby gear and orthopedic devices. *Journal of Orthopaedic Research*, 39(5), 941–949. <https://doi.org/10.1002/jor.24818>
- Siegel, A. C., and Burton, R. V. (1999). Effects of baby walkers on motor and mental development in human infants. *Journal of developmental and behavioral pediatrics: JDBP*, 20(5), 355–361. <https://doi.org/10.1097/00004703-199910000-00010>
- Siegel, D.N., Siddicky, S.F., Davis, W.D., Mannen, E.M., (2022). Coordinated Movements and Muscle Activation During Infant Roll Initiation.
- Siegel, D.N., Siddicky, S.F., Davis, W.D., Mannen, E.M., (2023). Infant Rolling Coordination Depends on the Mechanical Environment. *American Academy of Pediatrics Conference Abstract Submission*.
- Siegel, D.N., Siddicky, S.F., Davis, W.D., Mannen, E.M., (2023). Mechanical Environment Affects Muscle Utilization During Infant Rolling. *Northwest Biomechanics Symposium Abstract*.
- Siren, P. M., and Siren, M. J. (2011). Critical diaphragm failure in sudden infant death syndrome. *Upsala journal of medical sciences*, 116(2), 115–123. <https://doi.org/10.3109/03009734.2010.548011>
- Sivieri, E.M., Gerdes, J.S. and Abbasi, S. (2013), Effect of HFNC flow rate, cannula size, and nares diameter on generated airway pressures: An in vitro study. *Pediatr. Pulmonol.*, 48: 506-514. <https://doi.org/10.1002/ppul.22636>.
- Sly PD, Lanteri CJ, Kelly JH, Meretoja O. Disturbance in respiratory mechanics with extreme truncal flexion during anaesthesia in children. *Anaesth Intensive Care*. 1991 May;19(2):220-4. doi: 10.1177/0310057X9101900212. PMID: 2069243.
- Smith, A.P.R., Saiki, T., Hannam, S., Rafferty, G.F., Greenough, A. (2010). The effects of sleeping position on ventilatory responses to carbon dioxide in premature infants. *Thorax* 65, 824–828. <https://doi.org/10.1136/thx.2009.127837>.
- Squires, J., & Bricker, D. (2009). *Ages & Stages Questionnaires®, Third Edition (ASQ®-3): A Parent-Completed Child Monitoring System*. Baltimore: Paul H. Brookes Publishing Co., Inc.
- Stark AR, Thach BT. (1976). Mechanisms of airway obstruction leading to apnea in newborn infants. *J Pediatr*. 89(6):982-5. doi: 10.1016/s0022-3476(76)80615-4. PMID: 993928.
- Swift, P. G., and Emery, J. L. (1973). Clinical observations on response to nasal occlusion in infancy. *Archives of disease in childhood*, 48(12), 947–951. <https://doi.org/10.1136/adc.48.12.947>
- Thach BT, Stark AR. (1979). Spontaneous neck flexion and airway obstruction during apneic spells in preterm infants. *J Pediatr*. 94(2):275-81. doi: 10.1016/s0022-3476(79)80843-4. PMID: 762624.
- Thamsuwan, O. and Johnson, P. W. (2022). Machine learning methods for electromyography error detection in field research: An application in full-shift field assessment of shoulder muscle activity in apple harvesting workers. *Applied Ergonomics*, 98. <https://doi.org/10.1016/j.apergo.2021.103607>.
- Thelen E. (1986). Treadmill-elicited stepping in seven-month-old infants. *Child Dev*. 57(6):1498-506. PMID: 3802974.








- Tonkin SL, McIntosh CG, Hadden W, Dakin C, Rowley S, Gunn AJ. (2003). Simple infant carrier insert to prevent upper airway narrowing in preterm infants: a pilot study. *Pediatrics*. 112(4):907–913
- U.S. Census Bureau (2022). <https://www.census.gov/quickfacts/boisecitycityidaho>
- U.S. EPA. (2009). *Metabolically Derived Human Ventilation Rates: A Revised Approach Based Upon Oxygen Consumption Rates (Final Report, 2009)*. U.S. Environmental Protection Agency, Washington, DC, EPA/600/R-06/129F.
- Voss, D.E., Ionta, M.K., Myers, B.J., (1985). *Proprioceptive Neuromuscular Facilitation: Patterns and Techniques*. Harper and Row, Philadelphia, P.
- Wang J, Siddicky SF, Carroll JL, Rabenhorst BM, Bumpass DB, Whitaker BN, Mannen EM. (2020). Do inclined sleep surfaces impact infants' muscle activity and movement? A safe sleep product design perspective, *Journal of Biomechanics*. 111:109999. doi: 10.1016/j.jbiomech.2020.109999. PMID: 32862027.
- Wang J, Siddicky SF, Carroll JL, Rabenhorst BM, Bumpass DB, Whitaker BN, Mannen EM. (2021). Infant inclined sleep product safety: A model for using biomechanics to explore safe infant product design. *J Biomech* 128:110706. doi: 10.1016/j.jbiomech.2021.110706. PMID: 34624615.
- Ward, S. L., Bautista, D. B., and Keens, T. G. (1992). Hypoxic arousal responses in normal infants. *Pediatrics*, 89(5 Pt 1), 860–864. PMID: 1579395.
- Watchko JF, Mayock DE, Standaert TA, Woodrum DE. The ventilatory pump: neonatal and developmental issues. *Adv Pediatr*. 1991;38:109-34. PMID: 1927697.
- Whitehead K, Laudiano-Dray MP, Meek J, Fabrizi L. (2018). Emergence of mature cortical activity in wakefulness and sleep in healthy preterm and full-term infants. *Sleep*. 41(8):zsy096. doi: 10.1093/sleep/zsy096. PMID: 29762768; PMCID: PMC6093466.
- Wilson, S. L., Thach, B. T., Brouillette, R. T., and Abu-Osba, Y. K. (1980). Upper airway patency in the human infant: influence of airway pressure and posture. *Journal of applied physiology: respiratory, environmental and exercise physiology*, 48(3), 500–504. <https://doi.org/10.1152/jappl.1980.48.3.500>
- Wolfson MR, Greenspan JS, Deoras KS, Allen JL, Shaffer TH. (1992). Effect of position on the mechanical interaction between the rib cage and abdomen in preterm infants. *J Appl Physiol* (1985). 72(3):1032-8. doi: 10.1152/jappl.1992.72.3.1032. PMID: 1533209.
- Wulbrand, H., McNamara, F., and Thach, B. T. (1998). Suppression of sigma spindle electroencephalographic activity as a measure of transient arousal after spontaneous and occlusion-evoked sighs and startles. *Pediatric research*, 44(5), 767–773. <https://doi.org/10.1203/00006450-199811000-00021>
- Yang, Ted. (2022). *Injuries and Deaths Associated with Nursery Products Among Children Younger than Age Five*. Consumer Product Safety Commission.
- Yiallourou, S.R., Walker, A.M., Horne, R.S.C. (2008). Effects of sleeping position on development of infant cardiovascular control. *Arch. Dis. Child*. 93, 868–872. <https://doi.org/10.1136/adc.2007.132860>.



## Appendix A: Seated Product Information

Below is the table of product information for the 24 seated products included in the study.

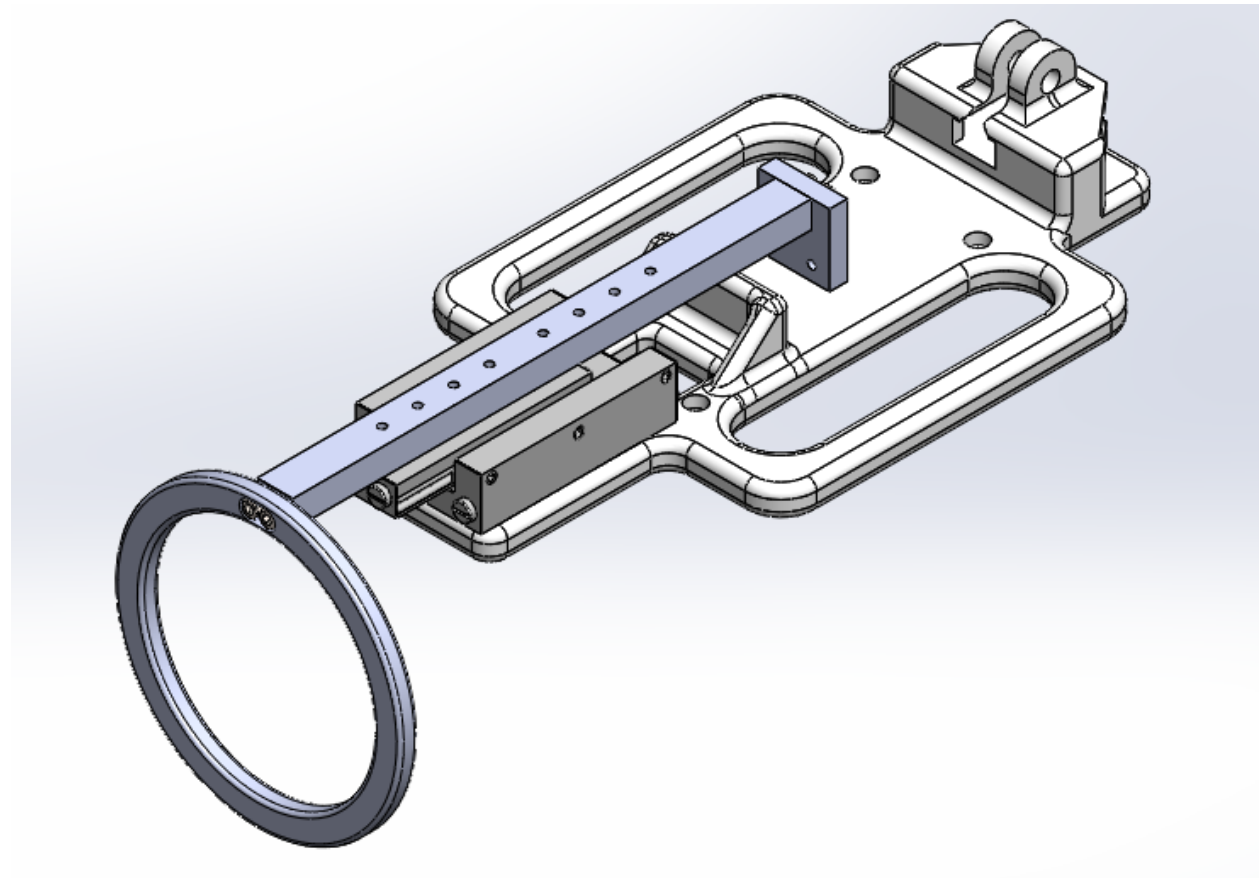
Category	Product Number	Name	Link	Vendor	Price	Reasoning	Photo
Infant Carriers	S05	[REDACTED]	[REDACTED]	[REDACTED]	\$90	Car seat/carrier combo; basic design	
	S06	[REDACTED]	[REDACTED]	[REDACTED]	\$300	Higher-end product with apparently different soft goods	
	S07	[REDACTED]	[REDACTED]	[REDACTED]	\$100	Common design	
	S08	[REDACTED]	[REDACTED]	[REDACTED]	\$420	Higher-end product with apparently different soft goods	
Bouncers	S09	[REDACTED]	[REDACTED]	[REDACTED]	\$200	Appears to have a high incline angle, not very plush	
	S10	[REDACTED]	[REDACTED]	[REDACTED]	\$300	Pictured with very small babies; appears plush	
	S11	[REDACTED]	[REDACTED]	[REDACTED]	\$50	Appears to be very plush; lower end vs. others in category	
	S12	[REDACTED]	[REDACTED]	[REDACTED]	\$60	Standard basic looking bouncer with plush head rest	

Category	Product Number	Name	Link	Vendor	Price	Reasoning	Photo
Strollers	S13	[REDACTED]	[REDACTED]	[REDACTED]	\$170	Stroller with bassinet mode	
	S14	[REDACTED]	[REDACTED]	[REDACTED]	\$530	Convertible car seat to stroller working with or without car seat; can use this car seat as one of the infant carrier/car seat options	
	S15	[REDACTED]	[REDACTED]	[REDACTED]	\$450	Popular jogging style	
	S16	[REDACTED]	[REDACTED]	[REDACTED]	\$69	Budget , different reclining angles	
Rockers	S17	[REDACTED]	[REDACTED]	[REDACTED]	\$35	Called a "rocker"; hybrid infant/toddler design	
	S18	[REDACTED]	[REDACTED]	[REDACTED]	\$240	Unique rocker design and movement modalities. Also has adjustable incline angle. This is a combo rocker/swing/bouncer	
	S19	[REDACTED]	[REDACTED]	[REDACTED]	\$220	High-end rocker; unique design.	
	S20	[REDACTED]	[REDACTED]	[REDACTED]	\$55	Lower-end design; hybrid with bouncer	

Category	Product Number	Name	Link	Vendor	Price	Reasoning	Photo
Swings	S21	[REDACTED]	[REDACTED]	[REDACTED]	\$135	Pillow-like surface, appears to have a large incline	
	S22	[REDACTED]	[REDACTED]	[REDACTED]	\$119	Common design of the laying surface with a removable plush body support. Unique product design, features a removable rocker	
	S23	[REDACTED]	[REDACTED]	[REDACTED]	\$50	Budget option, simple design, minimal soft goods	
	S24	[REDACTED]	[REDACTED]	[REDACTED]	\$80	Unique design with apparently minimal soft goods	
Infant Floor Seats	S25	[REDACTED]	[REDACTED]	[REDACTED]	\$41	Unique design, does not seem to fit in a specific category. . Very, very plush	
	S26	[REDACTED]	[REDACTED]	[REDACTED]	\$38	Unique design, does not seem to fit in a specific category. Soft fabric seat with built-in head support for baby	
	S28	[REDACTED]	[REDACTED]	[REDACTED]	\$65	Soft-looking head support	
	S29	[REDACTED]	[REDACTED]	[REDACTED]	\$75	Designed for little babies (3-10 months)	

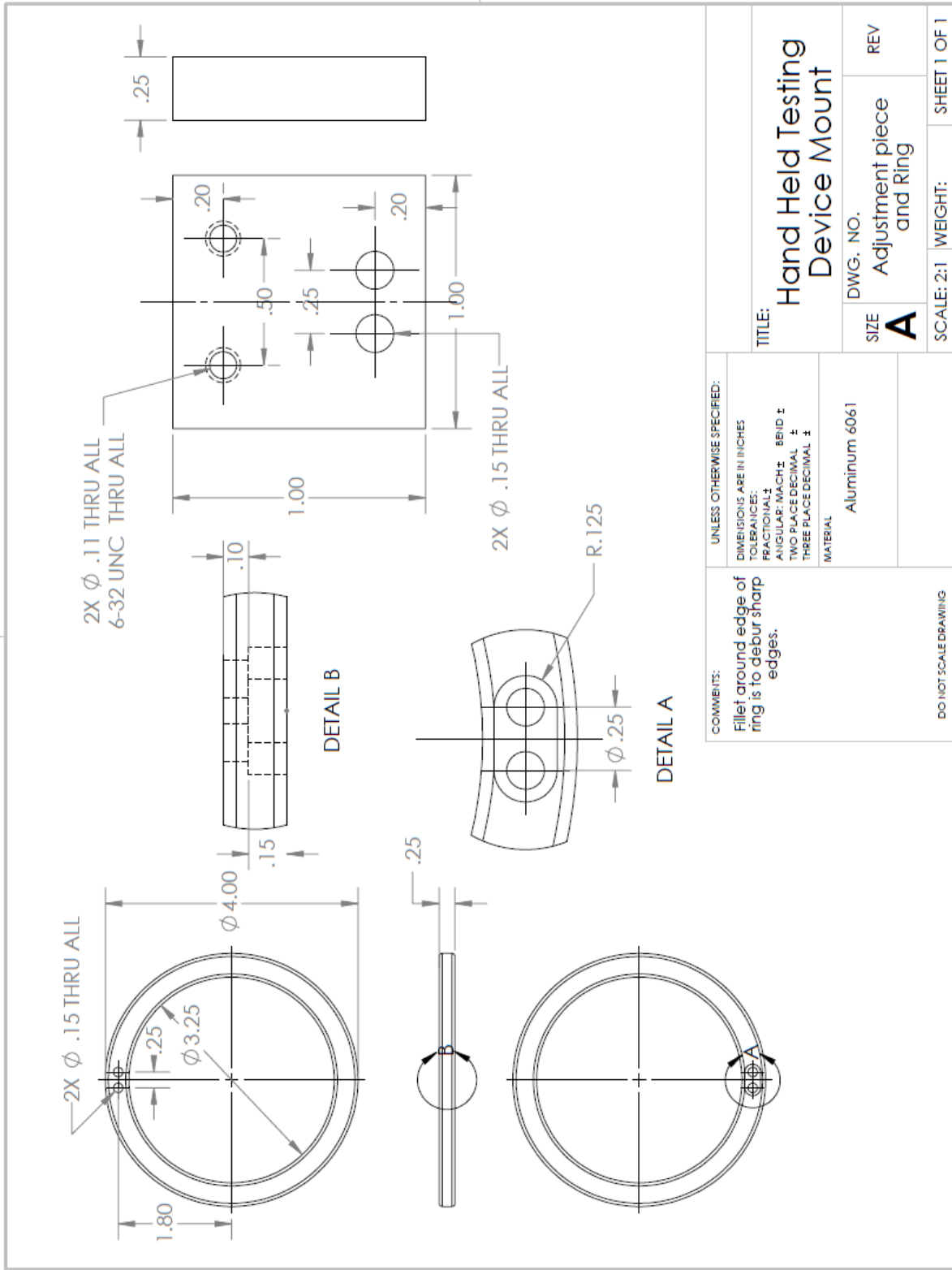
## Appendix B: Handheld Firmness Tester Details

Below are a 3D rendering and three individual engineering drawings of the components required for the handheld firmness tester device.



2

1



B

A

COMMENTS:  
 Fillet around edge of ring is to debur sharp edges.

UNLESS OTHERWISE SPECIFIED:  
 DIMENSIONS ARE IN INCHES  
 TOLERANCES:  
 FRACTIONAL:  $\pm$   
 ANGULAR: MACH  $\pm$  BEND  $\pm$   
 TWO PLACE DECIMAL  $\pm$   
 THREE PLACE DECIMAL  $\pm$   
 MATERIAL:  
 Aluminum 6061

DO NOT SCALE DRAWING

TITLE:  
**Hand Held Testing Device Mount**

DWG. NO.  
 Adjustment piece and Ring

REV

SIZE **A**

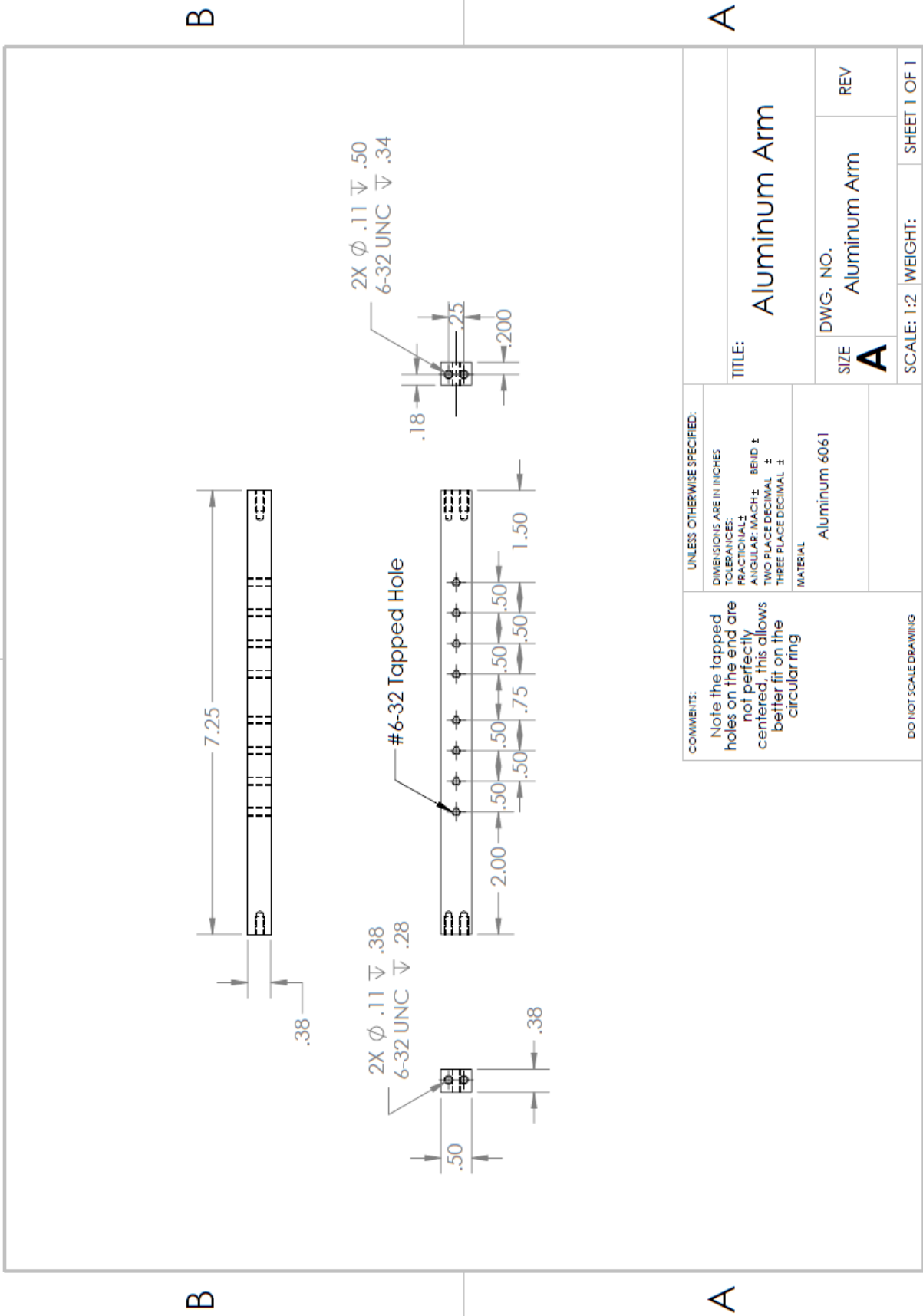
SCALE: 2:1 | WEIGHT: | SHEET 1 OF 1

2

1

2

1



B

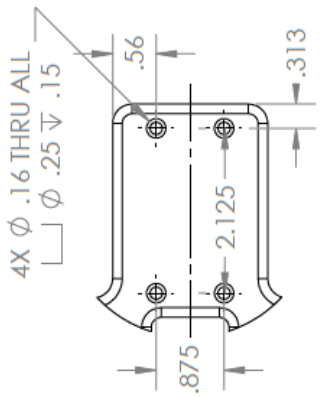
A

COMMENTS: Note the tapped holes on the end are not perfectly centered, this allows better fit on the circular ring	UNLESS OTHERWISE SPECIFIED: DIMENSIONS ARE IN INCHES TOLERANCES: FRACTIONAL: ANGULAR: MACH: $\pm$ .010 TWO PLACE DECIMAL: $\pm$ .005 THREE PLACE DECIMAL: $\pm$ .001 MATERIAL: Aluminum 6061	TITLE: Aluminum Arm	
		DWG. NO. Aluminum Arm	REV
DO NOT SCALE DRAWING		SCALE: 1:2	WEIGHT:

2

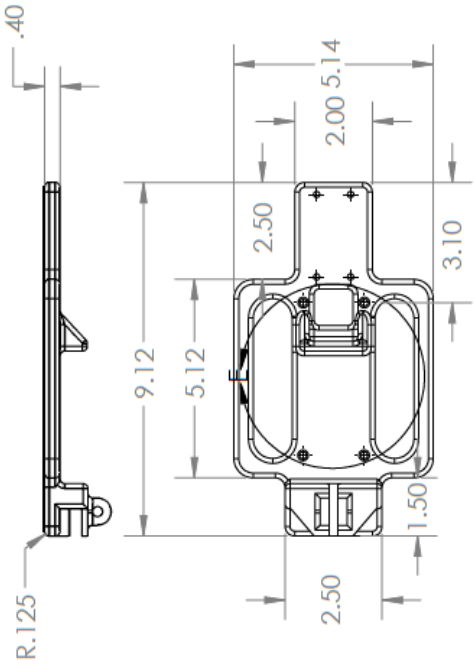
1

2

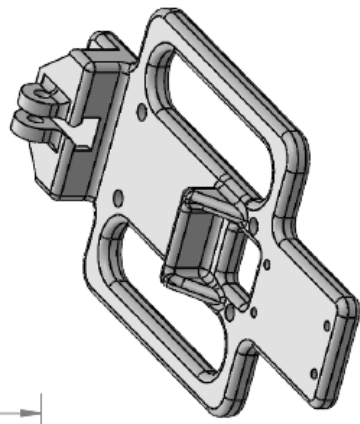


DETAIL A  
SCALE 1 : 2

1

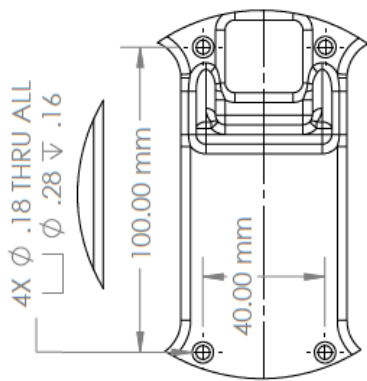


B



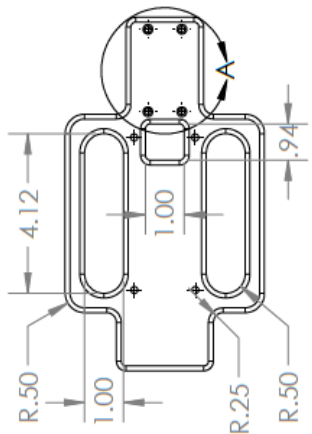
A

2



DETAIL E  
SCALE 1 : 2

1



COMMENTS: Device is meant to be 3D printed. 1/8" fillets on edge for comfort. Other fillets included to reduce stress concentration, exact dimension can be modified.	UNLESS OTHERWISE SPECIFIED: DIMENSIONS ARE IN INCHES FRACTIONALS: ANGULARS: MACH 1 TWO PLACE DECIMAL 1 THREE PLACE DECIMAL 1 MATERIAL 3D Printed Materials: PLA, ABS, Carbon Fiber Reinforced Plastic	TITLE: <b>Hand Held Testing Device Mount</b>	
		DWG. NO. Hand Held Testing Device Mount_A	REV REV
DO NOT SCALE DRAWING		SCALE: 1:4	WEIGHT:

2

1